

| CO | A | Date | Rev | Author | Description |
|----------|------------|------|-----|--------|--|
| 2014-001 | 2014-07-07 | R0 | LB | LB | New drawing. |
| 2015-001 | 2015-01-20 | R1 | LB | LB | Drawing no. implemented. |
| 152501 | 2015-06-17 | R2 | LB | LB | New labeling introduced and Air guiding plate updated. |
| 161902 | 2016-05-03 | R3 | AT | AT | New HMI, model table removed |
| 163804 | 2017-03-14 | R4 | LB | LB | New IP21 roof introduced. |

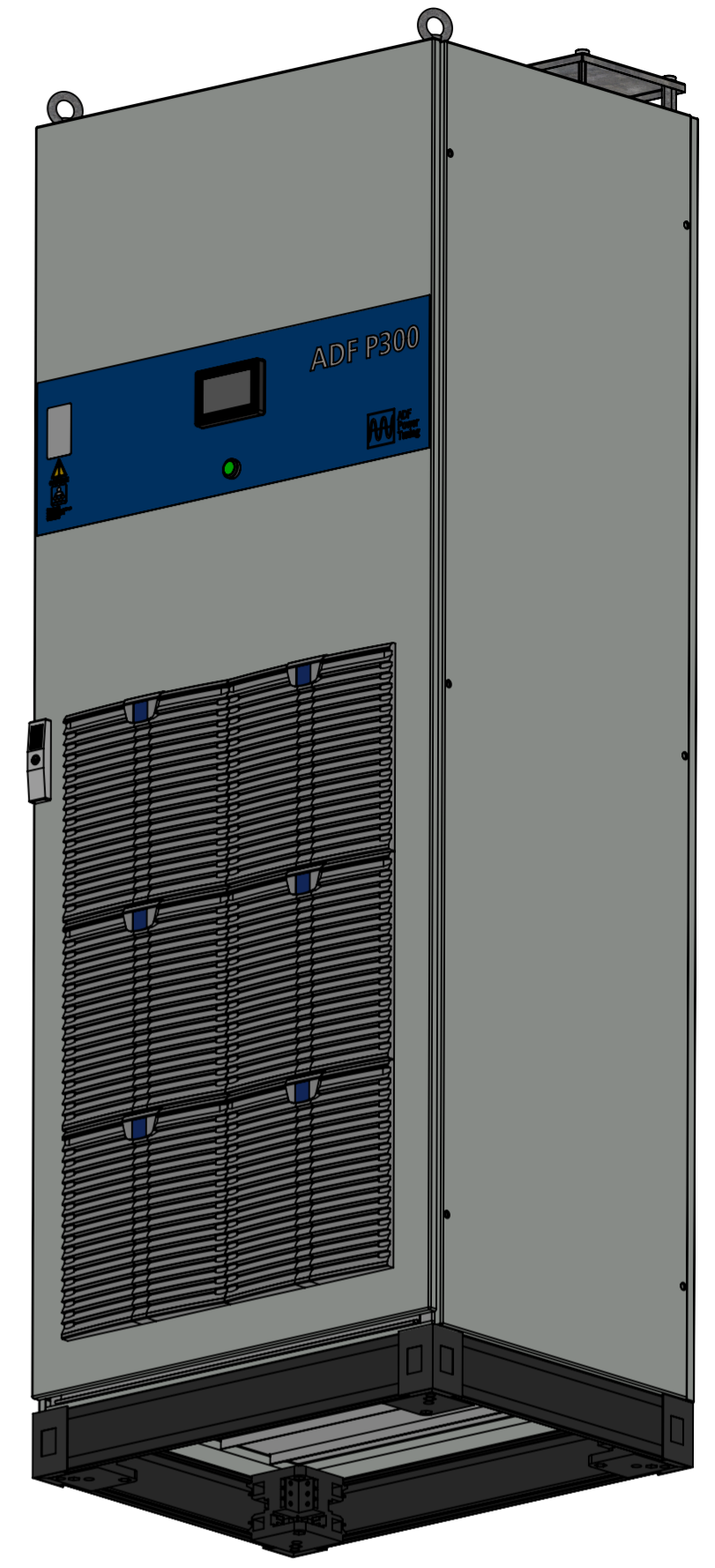
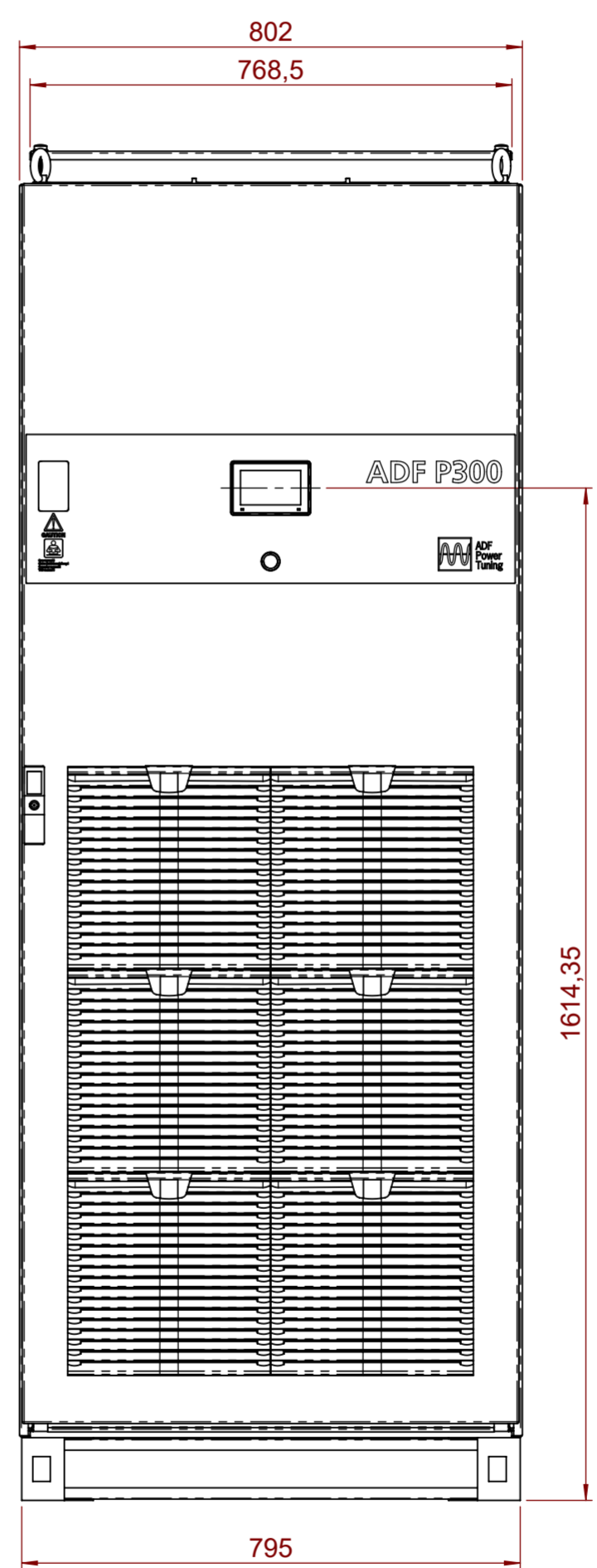
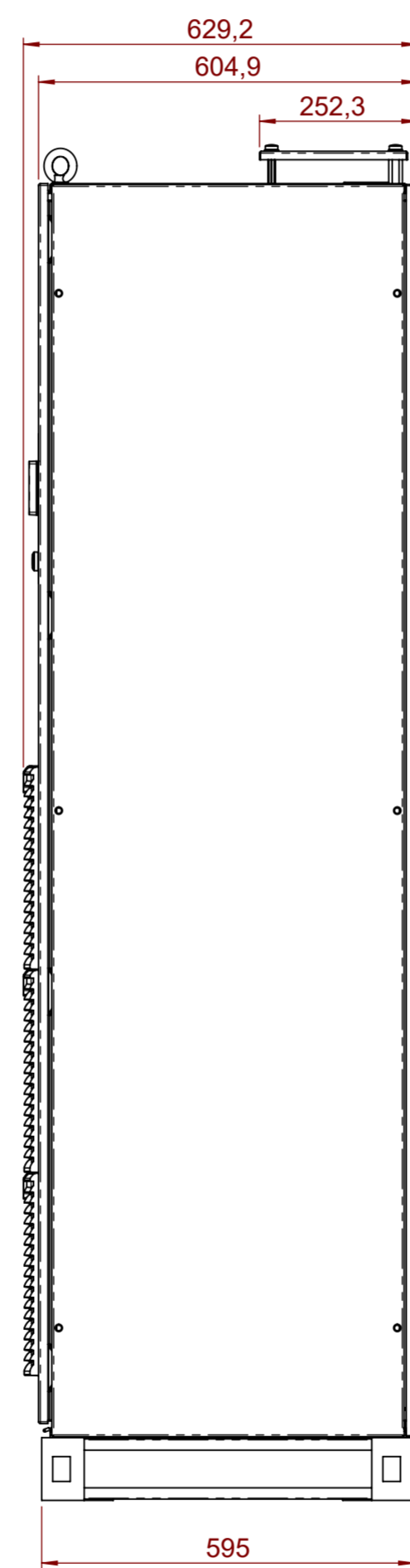
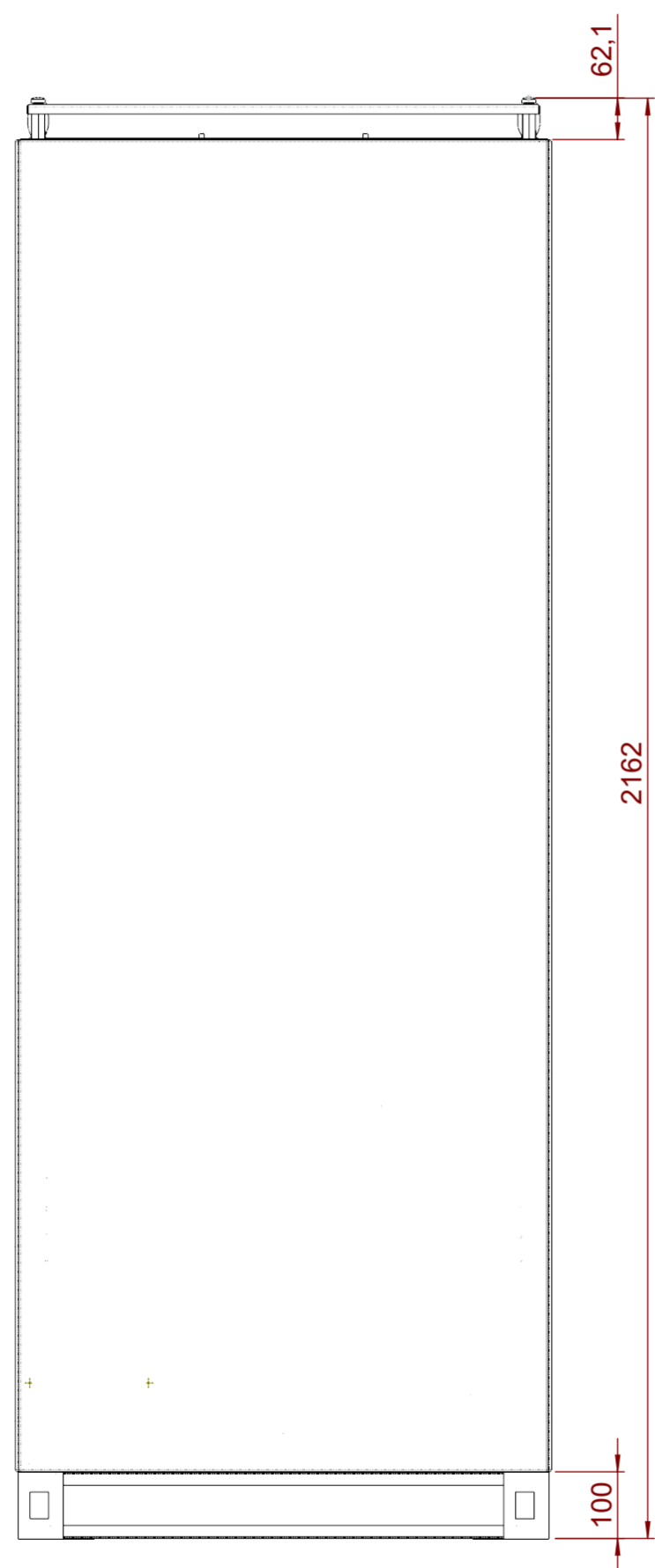
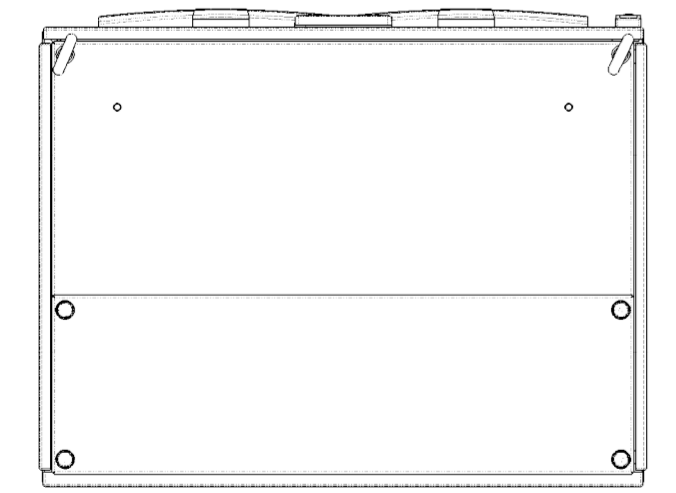
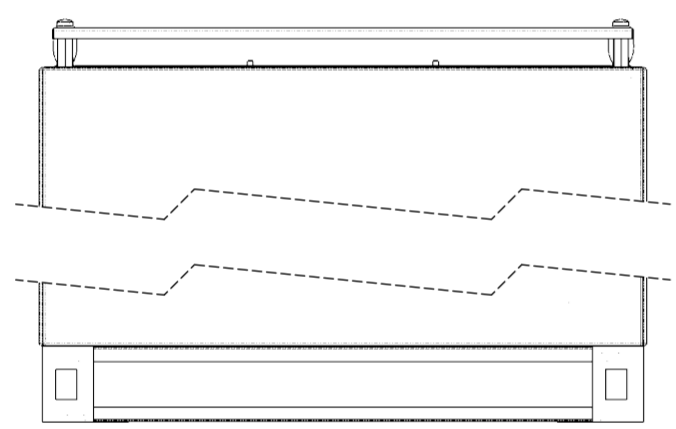
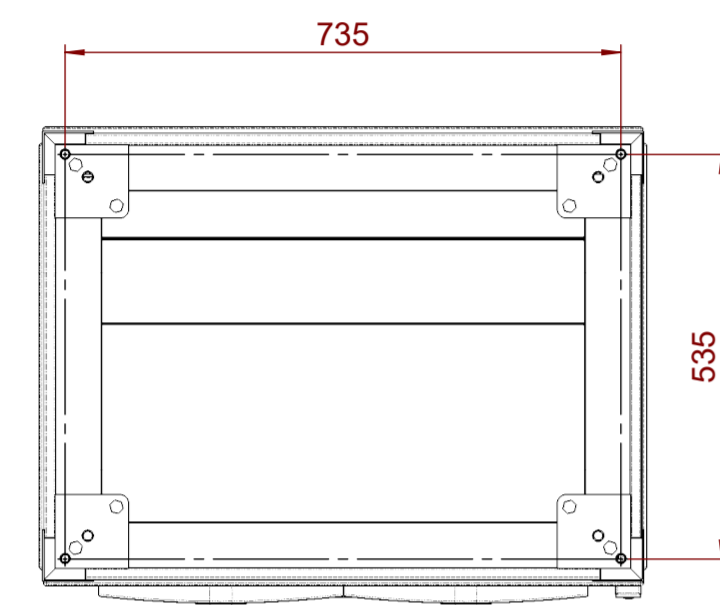

©2013 COMSYS AB. Note: This document is the sole property of COMSYS AB and may not without the written consent be copied, transmitted or otherwise disclosed to any third part.

| | | | | |
|--|-------------|---------------|-----------------------|--|
| UNLESS OTHERWISE STATED, FOLLOWING STANDARDS APPLY: ISO 2768-1 (M), ISO 286-2 (H12) | | Volume | View angle | COMSYS Creating Value through Power Quality™ |
| Reviewed by | Approved by | Mass | Sheet 1(1) | |
| Title | | Approved date | Size / Scale | Rev |
| ADF P300 v2 IP21 | | | A2 / 1:10 | R4 |
| | | | Drawing / Article NO. | |
| | | | 100857 | |