



ADF Power Tuning

THE SHAPE OF POWER TO COME

ADF P100/P300 User Manual 2.0.0

Safety notes

Read these instructions carefully and look at the equipment to become familiar with the product before trying to install, operate, or maintain it. The following special messages may appear throughout this manual to warn of potential hazards or to call attention to that which clarifies or simplifies a procedure:



ATTENTION: Identifies information about practices or circumstances that can lead to personal injury or loss of life, property damage, or economic loss.

NOTE

Provides additional information to clarify or simplify a procedure.



ATTENTION: Only qualified electrical personnel familiar with the construction and operation of this equipment and the hazards involved should install, adjust, operate, or service this equipment. Read and understand this manual and other applicable manuals in their entirety before proceeding. Failure to observe this precaution could result in severe bodily injury or loss of life.

ATTENTION: The product contains DC bus capacitors which retain hazardous voltages in excess of 1000V after input power has been disconnected. After disconnecting input power, wait at least sixty (60) minutes for the DC bus capacitors to discharge and then check the voltage with a voltmeter to ensure the DC bus capacitors are discharged before touching any internal components. Failure to observe this precaution could result in severe bodily injury or loss of life.

ATTENTION: Before manipulating current transformers, make sure that the secondary is short-circuited. Never open the secondary of a loaded current transformer. You must always wear isolating gloves and eye-protection when working on electrical installations. Also make sure that all local safety regulations are fulfilled.

ATTENTION: Only qualified personnel or other trained personnel who understand the potential hazards involved may make modifications to the product. Any modifications may result in uncontrolled operation. Failure to observe this precaution could result in damage to equipment and bodily injury. Although reasonable care has been taken to provide accurate and authoritative information in this document, no responsibility is assumed by Comsys for any consequences arising out of the use of this material.

The information in this document is subject to change without notice.

© 2018 Comsys AB. All rights reserved.

Product identification

The product identification label is found inside the door of the cabinet. Remember to check that your supply is compatible with the technical data stated on the label before installing and commissioning the Active Filter.

Active Filter ADF P300

Technical data:

Line voltage: 380 - 480 V
 Frequency: 50/60 Hz
 Current capacity: 120 A
 Protection class: IP21
 Cooling medium: Air
 Ambient temperature: 0 - 40°C

Product identification:

Model: ADF P300-120/480_T-B-----21
 Art. No.: 100 626

Serial number: 123456



Comsys AB
www.comsys.se
 Made in Sweden

This manual applies to products listed in the table below:

Table 1: Applicable ADF products

Product Line	Models	Current rating	Voltage
ADF P100 Air cooled, 3 wire	ADF P100-70/480	70 A _{RMS}	208 – 480 V
	ADF P100-100/480	100 A _{RMS}	
	ADF P100-130/480	130 A _{RMS}	
ADF P100 Air cooled, 3 wire	ADF P100-90/690	90 A _{RMS}	480 – 690 V
ADF P100N Air cooled, 4 wire	ADF P100N-100/415	100 A _{RMS} / 300 A _{RMS} (Neutral)	208 – 415 V
ADF P300 Air cooled, 3 wire	ADF P300-100/480	100 A _{RMS}	208 – 480 V
	ADF P300-200/480	200 A _{RMS}	
	ADF P300-300/480	300 A _{RMS}	
	ADF P300-80/690	80 A _{RMS}	480 – 690 V
	ADF P300-160/690	160 A _{RMS}	
	ADF P300-240/690	240 A _{RMS}	
ADF P300N Air cooled, 4 wire	ADF P300N-100/480	100 A _{RMS} / 300 A _{RMS} (Neutral)	208 – 480 V
ADF P300W Water cooled, 3 wire	ADF P300W-150/480	150 A _{RMS}	208 – 480 V
	ADF P300W-300/480	300 A _{RMS}	
	ADF P300W-450/480	450 A _{RMS}	
	ADF P300W-140/690	140 A _{RMS}	480 – 690 V
	ADF P300W-280/690	280 A _{RMS}	
	ADF P300W-420/690	420 A _{RMS}	
ADF P300v2 UL	ADF P300-110/480-UL	110 A _{RMS}	208 – 480 V

Air cooled, 3 wire	ADF P300-220/480-UL	220 A _{RMS}	480 – 600 V
	ADF P300-330/480-UL	330 A _{RMS}	
	ADF P300-90/600-UL	90 A _{RMS}	
	ADF P300-180/600-UL	180 A _{RMS}	
	ADF P300-270/600-UL	270 A _{RMS}	
ADF P300v2 CE Air cooled, 3 wire	ADF P300-120/480	120 A _{RMS}	208 – 480 V
	ADF P300-240/480	240 A _{RMS}	
	ADF P300-360/480	360 A _{RMS}	
	ADF P300-90/690	90 A _{RMS}	480 – 690 V
	ADF P300-180/690	180 A _{RMS}	
	ADF P300-270/690	270 A _{RMS}	
ADF P100 v2B Air cooled, 3 wire	ADF P100-50/480	50 A _{RMS}	208 – 480 V
	ADF P100-75/480	75 A _{RMS}	
	ADF P100-90/480	90 A _{RMS}	
	ADF P100-120/480	120 A _{RMS}	
	ADF P100-150/480	150 A _{RMS}	

Standards

These products are CE compliant, which means that the products are in conformity with the European Community low voltage directives 72/23/EEC and 93/68/EEC and it bears the CE label.

The following standards apply:

Table 2: Standards

Standards	
Electromagnetic compatibility	EN 61000-6-2, EN 61000-6-4
Electrical design and safety	EN 50178 / VDE0160
Protection class	IP20 according to IEC 529 (ADF P100/P100N) IP21 according to IEC 529 (ADF P100/P100N/P300) IP43 according to IEC 529 (ADF P300) IP54 according to IEC 529 (ADF P300W)
Approval marking	72/23/EEC, 93/68/EEC CE-mark NMTR.E357863 and NMTR7.E357863 for UL508 and CSA22.2

Document revision

Table 3: Document revision

Revision	Date	History:	Status:
A	2008-02-19	ORIGINAL	RELEASED
A2	2008-08-10	REVISED FOR SCC2 CONTROL	RELEASED
A3	2009-11-25	REVISED FOR RELEASE 1.0	RELEASED
C1	2010-02-08	REVISED FOR RELEASE 1.1	RELEASED
C2	2010-06-04	REVISED UPDATED NAMING	RELEASED
C4	2010-09-30	REVISED FACTUAL ERROR	RELEASED
D06 (v 1.3.3)	2011-12-20	MAJOR REVISION NEW DOC NO	RELEASED
D07		SMALL FIXES	
D08 (v 1.4.0)	2012-06-08	MAJOR REVISION REVISED STRUCTURE AND CONTENT	RELEASED
D09	2012-11-27	NETWORK APPENDICES ADDED	RELEASED
D10	2013-01-14	ADF P100 REFERENCES ADDED	RELEASED
D12 (v 1.4.8)	2013-03-21	MAJOR REVISION	RELEASED
D13	2013-11-08	MAJOR REVISION	
D14	2013-11-20	MINOR REVISION	RELEASED
D15	2014-01-17	MINOR REVISION	RELEASED
D16	2014-05-02	MAJOR REVISION	RELEASED

D17	2014-07-11	MINOR REVISION	RELEASED
D18 (v 1.7.0)	2014-10-30	MINOR REVISION	RELEASED
D19 (v 1.8.0)	2015-11-10	MAJOR REVISION	RELEASED
REV20 (v 1.9.0)	2016-05-19	MINOR REVISION	RELEASED
REV21 (v 2.0.0)	2018-02-02	MAJOR REVISION	RELEASED

Contents

Safety notes	2
Product identification	3
Standards	4
Document revision	4
Contents	6
List of figures	10
List of tables	12
1 Overview	13
1.1 Content	13
1.2 Organization of manuals.....	13
1.3 Related documentation.....	13
1.4 Manual structure.....	13
2 Feature overview	15
2.1 General	15
2.2 Power Factor Compensation – PFC.....	15
2.3 Flicker	15
2.4 Load balancing	15
2.5 Harmonics	15
2.6 Multi-master parallel system support.....	16
2.7 Modbus TCP server	16
3 ADF Dashboard (Web User Interface)	17
3.1 Introduction.....	17
3.1.1 ADF Dashboard versions.....	17
3.1.2 Web browser compatibility	17
3.1.3 Connecting to the ADF.....	18
3.1.4 Default network settings.....	19
3.2 Overview of the ADF dashboard (WUI)	19
3.2.1 Toolbar	19
3.2.2 Windows.....	21
4 Commissioning procedure	22
4.1 Power up the control computer	22
4.2 Connect PC to the ADF and enter the WUI	22
4.3 Performing system setup	22
4.3.1 PP-module type	23
4.3.2 PP-module configuration.....	24
4.3.3 PP-module configuration extender	24
4.3.4 PP-module current limitation.....	24
4.3.5 Nominal system voltage.....	25
4.3.6 System frequency	25

4.3.7 CT connection	25
4.3.8 CT ratio	25
4.3.9 Invert CT polarity.....	25
4.3.10 Number of parallel systems	25
4.3.11 Grounding system	25
4.3.12 Model key.....	26
4.3.13 License key #1-4.....	26
4.3.14 Reset default settings	26
4.4 Evaluate the system diagnostics	26
4.5 Perform final system configuration	27
5 Configuration.....	28
5.1 Configuration settings	28
5.1.1 Date and time.....	28
5.1.2 Language	28
5.1.3 Temperature unit.....	28
5.1.4 Autostart on boot.....	28
5.1.5 Autorestart on alarm	28
5.1.6 Standby function	29
5.1.7 Standby wake-up level.....	29
5.1.8 Standby sleep level	29
5.1.9 Standby wake-up delay.....	29
5.1.10 Standby sleep delay.....	29
5.1.11 Resonance limit	30
5.1.12 HMI default view	30
5.1.13 Digital outputs	30
5.1.13.1 Alarm output relay	30
5.1.13.2 User configurable relay	30
5.1.14 Digital inputs	30
5.2 Compensation settings	31
5.2.1 PFC mode	32
5.2.2 Load balancing.....	32
5.2.3 Harmonics compensation	32
5.3 Network settings.....	34
5.3.1 TCP/IP networking settings.....	34
5.3.1.1 Address mode	34
5.3.1.2 IP address	34
5.3.1.3 Subnet mask	35
5.3.1.4 Gateway address	35
5.3.1.5 Primary and secondary DNS addresses	35
5.3.1.6 MAC address.....	35
5.3.1.7 Hostname	35

5.3.1.8 Admin Password	35
5.3.2 Modbus TCP server	35
5.3.3 Multi-master networking settings	35
5.3.3.1 Configuration	36
5.3.3.2 Node identifier	36
5.3.3.3 Node check	36
5.3.3.4 Bus status.....	36
5.3.3.5 Node status	36
5.4 Import and export settings	36
5.4.1 Exporting settings	37
5.4.2 Importing settings.....	37
6 Operation and monitoring	38
6.1 System states and Events	38
6.1.1 Acknowledging alarms	38
6.1.2 Log data recorder.....	39
6.1.3 States and events	39
6.2 Starting and stopping	40
6.3 Measurement.....	40
6.4 Waveform view.....	41
6.4.1 CT current	41
6.4.2 Compensation current.....	42
6.4.3 Phase voltage	42
6.5 Spectrum view	42
6.5.1 CT current	43
6.5.2 Compensation current.....	43
6.5.3 Phase voltage	44
6.6 Software update.....	44
6.6.1 Updating SCC2	45
6.6.2 Updating HMI3	47
7 Human Machine Interface (HMI2).....	48
7.1 HMI overview.....	48
7.2 Commissioning using the HMI	48
7.2.1 System setup	48
7.2.2 Evaluating system diagnostics.....	49
7.3 Configuration using the HMI	51
7.3.1 Compensation setup menu	52
7.3.2 Configuration setup menu.....	53
7.3.3 Digital IO setup menu	54
7.3.4 System admin menu	54
7.3.5 Spectrum I _{CT}	55
7.3.6 Spectrum I _{OUT}	55

7.3.7 Spectrum U	55
7.3.8 About menu	55
7.4 Operation using the HMI	56
7.4.1 Starting and stopping	56
7.4.2 Displaying measurement data	56
7.4.3 Displaying alarms and warnings	56
8 Power Indicator Button (PIB)	59
9 Human Machine Interface 3 (HMI3)	60
9.1 HMI3 Overview	60
9.2 Root window	61
9.2.1 System setup	61
9.2.2 Diagnostics	61
9.2.3 Measurement	61
9.3 Alert	62
9.4 Main menu	62
9.5 Parameter Edit	63
9.6 Parameter Select	63
9.7 Setup	64
9.8 Configuration	65
9.9 Compensation / Compensation (alt)	66
9.10 System admin	67
9.11 About	67
Appendix A Modbus TCP server	68
A.1 Status registers	68
A.2 Control registers	71
A.3 Compensation settings	72
A.3.1 Primary compensation setting registers	72
A.3.2 Secondary compensation setting registers	74
A.4 CT current spectrum registers	77
A.5 ADF output current spectrum registers	77
A.6 Phase voltage spectrum registers	77
A.7 About registers	78

List of figures

Figure 1: Overview of the ADF Dashboard showing the About window	17
Figure 2: RJ45 socket directly on SCC2 control computer in ADF P300 and in system integration	18
Figure 3: RJ45 socket (X21) on ADF P100 bottom plate.....	18
Figure 4: Login window	18
Figure 5: The ADF Dashboard toolbar	19
Figure 6: Commissioning sequence.....	22
Figure 7: System setup window	23
Figure 8: Diagnostics window – with override current threshold check	27
Figure 9: Diagnostics window	27
Figure 10: Configuration settings window	28
Figure 11: Displaying live value of $I_{load, fund}$ in percent.....	29
Figure 12: Compensation settings window	31
Figure 13: Compensation settings window locked.....	32
Figure 14: Phase-angle calibration in compensation window	33
Figure 15: Amplitude calibration in compensation window	33
Figure 16: Network settings window	34
Figure 17: Multi-master Networking Settings	36
Figure 18: Import and export settings buttons	36
Figure 19: Exported settings file.....	37
Figure 20: Importing settings file	37
Figure 21: Settings file imported	37
Figure 22: The Events window.....	38
Figure 23: System states	39
Figure 24: The Measurement window.....	40
Figure 25: Waveform view window showing CT current	41
Figure 26: Waveform view window showing Compensation current	42
Figure 27: Waveform view window showing Phase voltage	42
Figure 28: Hover function in the spectrum view window.....	43
Figure 29: Spectrum view window showing CT current.....	43
Figure 30: Spectrum view window showing Output current.....	43
Figure 31: Spectrum view window showing Phase voltage	44
Figure 32: Update software	44
Figure 33: Selecting a file for software update.....	45
Figure 34: Confirm SCC2 software update	45
Figure 35: Flashing SCC2.....	46
Figure 36: SCC2 software update complete	46
Figure 37: Confirm HMI3 software update	47
Figure 38: HMI3 software update complete	47
Figure 39: HMI overview	48

Figure 40: System setup in HMI	48
Figure 41: Diagnostics in the HMI	50
Figure 42: HMI menu structure	51
Figure 43: HMI LCD and keys in different operating states	56
Figure 44: Display of measurement in HMI	56
Figure 45: Alarm shown in HMI	57
Figure 46: PIB location	59
Figure 47: HMI3 main view	60
Figure 48: HMI3 menu overview	60
Figure 49: HMI3 System setup view	61
Figure 50: HMI3 Diagnostics view	61
Figure 51: HMI3 Measurement view	61
Figure 52: HMI3 Alert view	62
Figure 53: HMI3 Main menu view	62
Figure 54: HMI3 Parameter Edit view	63
Figure 55: HMI3 Parameter Select view	63
Figure 56: HMI3 About view	67

List of tables

Table 1: Applicable ADF products.....	3
Table 2: Standards.....	4
Table 3: Document revision	4
Table 4: Default IP settings	19
Table 5: Toolbar tools.....	19
Table 6: Managing windows.....	21
Table 7: Power module types.....	23
Table 8: Overview of measurement window functionality	41
Table 9: HMI description	48
Table 10: Setup menu	49
Table 11: Diagnostic codes.....	50
Table 12: Compensation setup menu	52
Table 13: Config settings menu	53
Table 14: Alarms settings menu.....	54
Table 15: Config settings menu	54
Table 16: Spectrum Ict menu	55
Table 17: Spectrum Iout menu.....	55
Table 18: Spectrum U menu	55
Table 19: About menu	55
Table 20: Measurements views	56
Table 21: Alarms, Warnings and States.....	57
Table 22: Power Indicator Button modes	59
Table 23: HMI3 Measurement table.....	62
Table 24: HMI3 Setup menu table	64
Table 25: HMI3 Configuration menu table	65
Table 26: HMI3 Compensation menu table	66
Table 27: HMI3 System admin menu table.....	67

1 Overview

1.1 Content

This manual describes the user interface and operation modes of the Comsys ADF P100/P300 series of Active Filters. The user can choose to use either the Human Machine Interface (HMI/HMI3) interface found at the cabinet door or the Web User Interface (WUI).

The manual assumes knowledge of the ADF P100/P300 products from reading the ADF P100/P300 Hardware Manuals.



ATTENTION: The Hardware Manual must be studied carefully before following the commissioning procedure. It describes the physical installation of the system and how it should be inspected prior to the first start-up.

1.2 Organization of manuals

The ADF P300 manual is organized in two parts, namely;

1. ADF P300 Hardware Manual, doc no 1 199 171
2. ADF P100/P300 User Manual, doc no 1 199 172 (this document)

The ADF P100 manual is organized in two parts, namely;

1. ADF P100/P100N Hardware Manual, doc no 1 199 273
2. ADF P100/P300 User Manual, doc no 1 199 172 (this document)

In case of system integration, a modified Hardware Manual by the integrator might exist. Otherwise the ADF P100/P100N Hardware Manual (doc no 1 199 273) can be used in combination with this ADF P100/P300 User Manual.

The Hardware Manual covers hardware related issues, such as installation, cable selection, CT configuration, preventive maintenance, and troubleshooting.

The user manual covers issues which are governed by the installed software in the system such as operation, initial configuration and commissioning. Hence, when the system is updated, a new User Manual is supplied.

1.3 Related documentation

- ADF P100/P100N Hardware Manual, doc no 1 199 273
- ADF P300 Hardware Manual, doc no 1 199 171
- ADF P100 Circuit diagram
- ADF P300 Circuit diagram
- ADF P100/P300 Service Manual

1.4 Manual structure

This manual starts out with a brief feature overview of the system described in general terms.

The *Web User Interface (WUI)*, also referred to as the *ADF Dashboard*, is then introduced. This is the recommended interface for commissioning, configuration and troubleshooting.

What follows next is a description of the commissioning procedure, consisting of an installation inspection, system setup and automated diagnostic tests.

After that, the configuration of other settings such as digital input and output, compensation settings and network settings are described.

The next section covers operation; starting and stopping the system, monitoring of the system alarms and events, displaying measurement data and updating the software.

Then follows a section covering the old *Human Machine Interface* (HMI2) and its features.

The section after that covers the *Power Indicator Button* (PIB) and how the most basic maneuvering and monitoring of the system can be performed using it.

The final section describes the touchscreen *Human Machine Interface 3* (HMI3).

2 Feature overview

This section gives an overview of the ADF P100/P300 compensation settings. The settings can be changed both using the HMI and WUI interfaces described in later sections of this manual. For an overview of the power principles of the ADF P100/P300 unit, please refer to the overview section in the Hardware Manual.

2.1 General

The ADF P100/P300 has two sets of compensation settings. One primary set and one secondary set. The system may be configured to switch between them using one of the digital inputs or Modbus TCP.

If the compensation power of the system is not enough to fulfill the requested settings, the system will scale down power factor correction, harmonics and load balancing in equal amounts.

By default, all compensation settings are disabled and should be configured as a part of system commissioning.

2.2 Power Factor Compensation – PFC

The ADF P100/P300 can be configured in static, dynamic, dynamic (inductive direction) or dynamic (capacitive direction) PFC mode.

In static mode, the system will produce a fixed amount of reactive power.

In dynamic mode, the system will try to maintain a fixed power factor in the grid. If the load changes, the ADF P100/P300 output will also change to maintain a fixed power factor. It is possible to choose a power factor between 0.5 capacitive and 0.5 inductive.

In dynamic inductive or capacitive mode, the system will try to maintain a fixed power factor in the grid. If the load changes, the ADF P100/P300 output will also change to maintain a fixed power factor. The system will however only output inductive current or capacitive current. It is possible to choose a power factor between 0.5 capacitive and 0.5 inductive.

2.3 Flicker

The ADF P100/P300 is capable of flicker compensation but must be commissioned by Comsys using special software. Please contact Comsys AB for more information.

2.4 Load balancing

The load balancing function can be used to even out the current drawn from a load as seen from the network. The ADF will draw balanced three-phase current from the network and provide the load with the unbalanced power it requires. This can be useful to prevent harmful voltage unbalance in the feeding gear when for example two-phase loads are connected to the network.

The function can compensate line to line in 3-phase 3-wire systems and line to neutral in 3-phase 4-wire systems.

2.5 Harmonics

This function can dampen or eliminate harmonics up to the 49th harmonic of the fundamental network frequency in a three-phase system.

The degree of compensation is configurable in percent for each harmonic with 0% being equal to no compensation and 100% being complete elimination of the harmonic.

In cases where a harmonic is unevenly distributed across the phases, support for unbalanced harmonics can be enabled.

In 4-wire systems, harmonics up to the 19th can be compensated on the neutral connection.

Sensorless Control of harmonics is supported with an option license key. In this mode, compensation takes place without the need for external sensors, i.e. without CTs.

NOTE Sensorless Control support is a license key activated option. If you wish to use this feature, please contact Comsys.

2.6 Multi-master parallel system support

The ADF P100/P300 product line supports intelligent multi-master parallel system support. The multi-master type of parallel operation is a way of running the system with the following benefits:

- Automatic selection and migration of the 'Master' system. When two or more systems are started up in this mode, they will auto-negotiate which one will become the master. If one of the systems trip or is shut down for maintenance, the remaining systems – automatically and on the fly – will renegotiate the new master. When the shutdown system is again restarted, renegotiation happens again on the fly.
- Load sharing between heterogeneous systems is automatic. For example, one ADF P300-360/480 and one ADF P300-240/480 can share the load evenly between its total of five modules.
- Robust operation of several ADF units in parallel even in closed loop configuration.
- When setting up several systems, settings are automatically migrated from the master to the slaves with zero user intervention.

Please refer to the corresponding Hardware Manual for details on how to properly connect and configure the multi-master bus.

NOTE Multi-master operation is an option that need to be ordered together with the system. The additional required hardware bus adapter that is also sold as a retrofit option. Please contact Comsys for more information.

2.7 Modbus TCP server

The ADF P100/P300 supports Modbus TCP (and UDP). The standard Ethernet connection is used. The protocol supports basic operations like starting and stopping, and features registers for status, alarms, measurements etc. Compensation settings can also be adjusted via Modbus.

Please see 'Appendix A Modbus TCP server' for more information.

NOTE Modbus TCP server support is a license key activated option. If you wish to use this feature, please contact Comsys.

3 ADF Dashboard (Web User Interface)

3.1 Introduction

The *ADF Dashboard* is the *Web User Interface (WUI)* of the ADF P100/P300 series.

Through the dashboard it is possible to:

- Start and stop the system
- Commission the system (e.g., changing system setup parameters and running diagnostics)
- Change compensation settings (e.g., harmonic compensation, reactive compensation, load balancing, etc.)
- Change system settings (e.g. digital in and out, time/date, TCP/IP networking, multi-master, etc.)
- Display waveforms of compensation currents, CT currents and voltages
- Display frequency spectrum of compensation current, CT current and voltages
- Display a vector diagram with phase angles, RMS values and THD of line voltages and line currents
- Update the software image on the SCC2 control computer
- Import and export settings

3.1.1 ADF Dashboard versions

This manual covers SCC2 software revision 2.0.0. The software revision and build date can be displayed by opening the *About window*. Also shown here is the *SCC2 serial number* and the *SCC2 identifier* which is used in conjunction with entered license keys to unlock optional features of the SCC2.

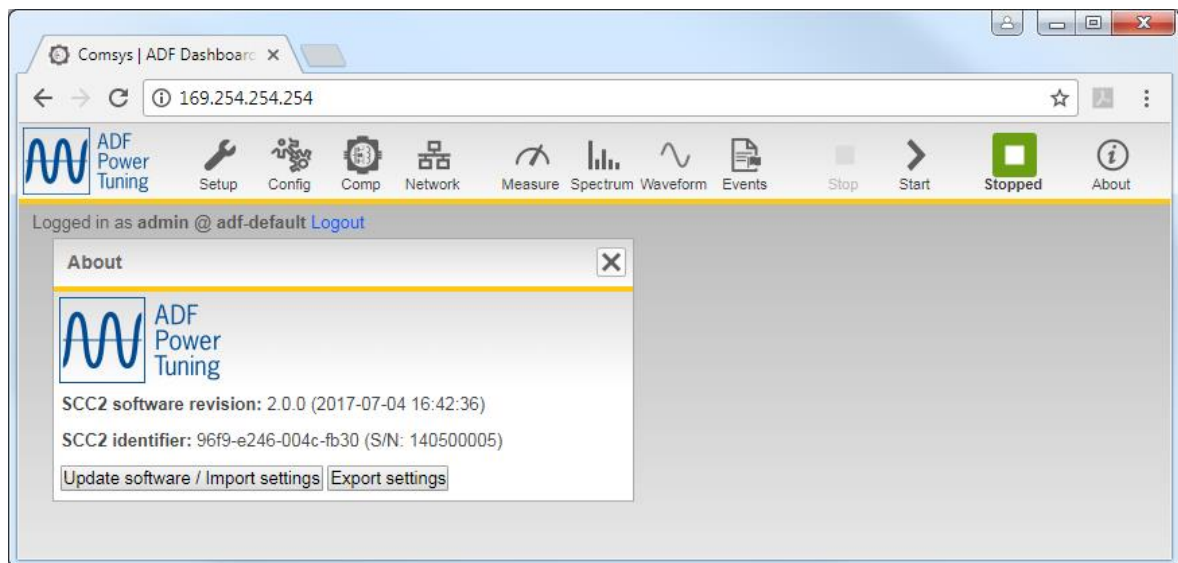

Figure 1: Overview of the ADF Dashboard showing the About window

NOTE When contacting customer support, please note the SCC2 software revision.

3.1.2 Web browser compatibility

The ADF Dashboard uses advanced functionality and therefore requires a recent web browser such as Google Chrome, Mozilla Firefox or Microsoft Edge.

3.1.3 Connecting to the ADF

The physical connection is made using a RJ45 cable. On a modern computer, there is no need to use a cross-wired RJ45 cable however this may be necessary when using older equipment. The location of the RJ45 socket in the ADF P300, system integration and ADF P100 is shown in Figure 2 and Figure 3 below:

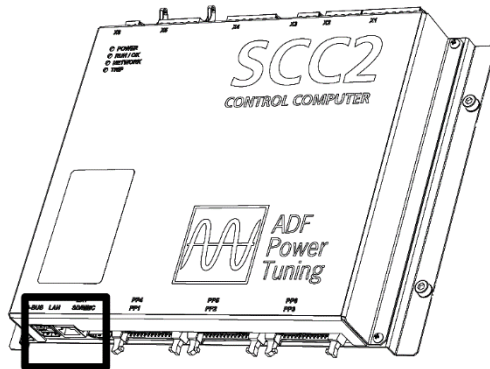

Figure 2: RJ45 socket directly on SCC2 control computer in ADF P300 and in system integration

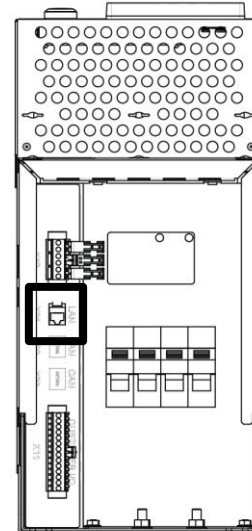

Figure 3: RJ45 socket (X21) on ADF P100 bottom plate

For commissioning and maintenance work it is preferable to connect to the ADF directly from a laptop via an RJ45 cable. For permanent supervision, the ADF should be permanently connected to the local area network. To find the IP address of a system using the HMI, see Section 7.3.8 or Section 9.11.

By default, the system is configured to use a Link-local IP address. This makes direct connection to the ADF very simple as it requires no configuration on the client PC. The client PC must be set to obtain an IP address automatically.

Connect the RJ45 cable to the ADF and power up the system using the switch in the door or PIB. Now connect the other end of the RJ45 cable to the client PC and open a web browser. Note that the process of address assignment may take up to two minutes. Point the web browser to <http://169.254.254.254/> and you will be presented with a login screen.

Login with the username **admin** and blank password (default setting). The password of the **admin** user can be changed in the *Network settings window* after login. Please see Section 5.3.1.8 for more information.

Upon successful login, the username and password will be stored for the current session. This means that when refreshing the page or reconnecting for example after loading new software, login will happen automatically. Close all web browser windows or use the *Logout* link to end the session and log out.

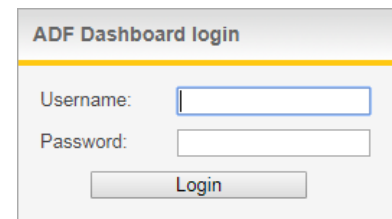



Figure 4: Login window



ATTENTION: Do not connect the Ethernet cable while the system is running or energized. Refer to Hardware Manual on how to prepare the system for maintenance.

 **ATTENTION:** The ADF should under no circumstance be connected directly to the internet. Always connect it behind a firewall to maintain good network security.

NOTE The default network settings are intended for direct connection between ADF and a client PC. The IP address must be changed if the ADF is to be connected to a network.

NOTE It is possible to reset network settings to their default values in the HMI; this can be desirable if an erroneous setting disables network access. See Section 7.3.4 or Section 9.10 for more information.

3.1.4 Default network settings

The default network settings are as follows:

Table 4: Default IP settings

Setting	Default value
Address Mode	Static IP
IP address	169.254.254.254
Subnet Mask	255.255.0.0
Gateway address	0.0.0.0
Primary DNS address	0.0.0.0 (unused)
Secondary DNS address	0.0.0.0 (unused)
MAC Address	SCC2 generated unique address
Hostname	adf-default

3.2 Overview of the ADF dashboard (WUI)



3.2.1 Toolbar















The main toolbar gives access to all functions in the Dashboard. Settings and measurement buttons open corresponding windows which control settings and overview measurements.

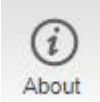

Figure 5: The ADF Dashboard toolbar

Table 5: Toolbar tools

Element	Symbol	Function
Settings group		
System setup		Opens the <i>System setup window</i> . This window is used for configuration of installation specific settings like CT ratio, network frequency, nominal system voltage, etc. This window is typically only used during commissioning. See Section 4.3.
Configuration settings		Opens the <i>Configuration settings window</i> . This window controls basic settings like alarm configuration, time and date, etc. See Section 5.1.
Compensation settings		Opens the <i>Compensation settings window</i> . This window controls the function of the ADF, allowing configuration of the different modes of compensation. See Section 5.2.





Network settings	 Network	Opens the <i>Network settings window</i> . The window allows configuration of the TCP/IP and multi-master bus settings of the ADF. See Section 0.
Monitoring group		
Measure	 Measure	Opens the <i>Measurement window</i> . This window displays a vector diagram of the line voltage and line current as measured by the system. Both the phase angles and the amplitudes are shown. See Section 6.3.
Spectrum	 Spectrum	Opens the <i>Spectrum window</i> . The spectrum window displays the frequency spectrum of CT currents, compensation currents and phase voltages for all harmonics up to the 49 th . See Section 6.5.
Waveform	 Waveform	Opens the <i>Waveform window</i> . The waveform window is used for displaying waveform plots of CT currents, compensation currents and phase voltages. See Section 6.4.
Events	 Events	Opens the <i>Event log window</i> . The Event log window shows a chronological view of the system events, alarms and warnings as they have happened. It also shows which alarms and warnings that are currently active and allows the alarms to be acknowledged. The log data recorder can also be controlled from here. See Section 6.1.
Controls group		
Stop	 Stop	Stop operation of the ADF. The system will still be on, but not compensating. See Section 6.2.
Start	 Start	Start operation of the ADF. The system will start compensating the load. See Section 6.2.
Status group		
Status	 Setup	The system is in Setup mode.
	 Diag	The system is in Diagnostics mode.
	 Charging	The system is pre-charging its DC-link.
	 Autostart	The system is about to autostart. This can be aborted by pressing the stop button.
	 Standby	The system is in Standby mode. It will start automatically when the start threshold is reached. This mode can be exit by pressing the stop button.
	 Stopped	The system is stopped and ready to start.
	 Running	The system is running.
	 Tripped	The system has tripped on an alarm and is stopped.
About group		

About		<p>Opens the about window.</p> <p>The about window shows the revision and build date of the software currently running on the SCC2 control computer as well as the unique system identifier of the SCC2. From here the software updater as well as the import/export settings feature can be reached.</p>
-------	---	---

3.2.2 Windows

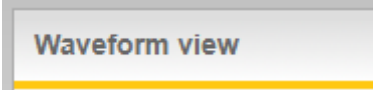
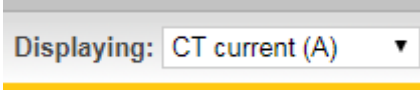
The windows in the *ADF Dashboard* can be moved around like windows on an ordinary desktop operating system.

Table 6: Managing windows

Element	Symbol	Function
Window title		Move window. Click and hold the window title to move the window.
Window drop down menu		Drop down the menu to select the desired view.
Apply		Click the button to apply the settings without closing the window.
OK		Click the button to apply the settings and close the window.
Close window		Click the button to close the window.



ATTENTION: If the ADF is connected to a network where it may be remotely started, the RJ45 cable should be unplugged during local operation to prevent unintended remote starts of the system.

4 Commissioning procedure



ATTENTION: The Hardware Manual must be studied carefully before following the commissioning procedure. It describes the physical installation of the system and how it should be inspected prior to the first start-up.

Before the system can be taken into operation the commissioning procedure described below will have to be completed.

The first step is to verify the installation and make sure that everything is connected properly.

Then using a PC connected to the ADF, the *System setup* can be performed. This is where all the system and installation specific settings are configured.

After the *System setup* has been completed, *Diagnostics mode* will be entered. Here, an extensive suite of automated diagnostic tests will be run to verify the entered settings as well as the installation. If errors are detected, it is required that they are corrected before the system can enter *Normal operation mode*.



Figure 6: Commissioning sequence

When all the diagnostic tests have been successful, the system will enter *Normal operation mode*. This is the default state for all subsequent starts after the commissioning has been completed.

While this guide assumes that a PC is used during commissioning, it is also possible to commission the system using the HMI. Use Section 0 or Section 9 in conjunction with this guide to do this.

Before proceeding, please make sure that:

- The Hardware Manual has been read through carefully, especially the sections covering installation and final inspection.
- All fuses are inserted.

4.1 Power up the control computer

When all the previous inspections have been performed successfully the system is ready to be powered up for the first time. Power on the system by turning the switch (old interface), pressing the PIB button (new interface) or powering up the system by other means in case of system integration.

Check that either the HMI or PIB/HMI3 light up.

4.2 Connect PC to the ADF and enter the WUI

Please refer to Section 3 for information on how to enter the WUI.

4.3 Performing system setup



The system setup is now ready to be performed. This is typically only done during commissioning and its goal is to configure system and installation specific settings that are deemed unlikely to change after commissioning.

The *System setup* window (Figure 7) will automatically be shown upon entering the WUI while in *System setup mode*. Use this window to configure the system. All settings are described in the subsections below.

In cases when the system has been delivered with license key activated options, these should be entered before configuring the other settings. Enter the license keys and click *Save and activate* make them take effect.

When all settings are correct, click *Run diagnostics* to save the system setup and enter *Diagnostics mode*.

NOTE Changing the *System setup* may automatically reset *Configuration settings*, *Compensation settings* and *Protection limits* back to default values.

NOTE The system may automatically start and run at idle for up to 30 seconds as a part of the diagnostics procedure.

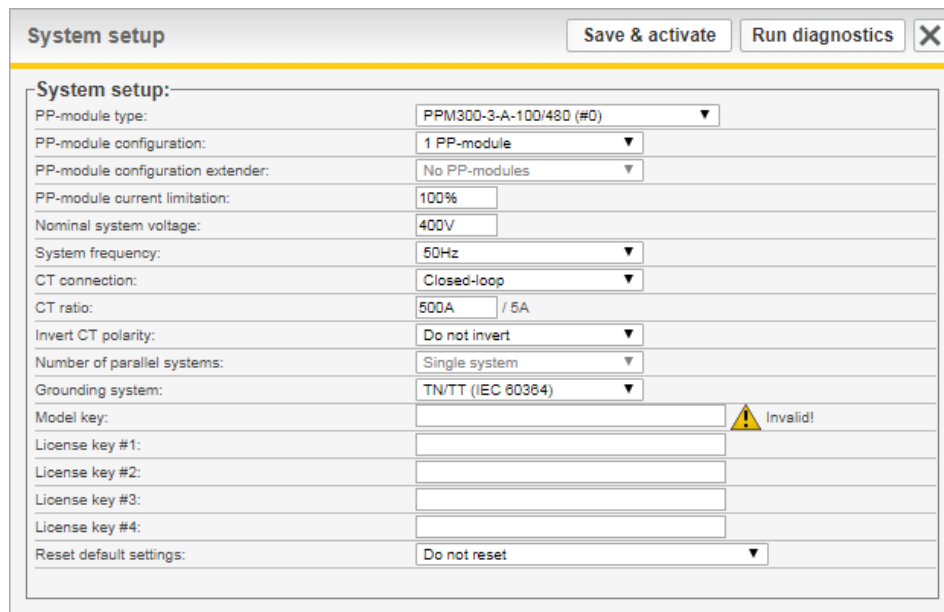

Figure 7: System setup window

4.3.1 PP-module type

The system can be equipped with several types of power modules depending on the requirements to be met. All modules in one system must be of the same type.

This software supports the following module types:

Table 7: Power module types

PP-module ID	Article name	Max line voltage	Maximum output current per PP	Overload mode percentage (Maximum output current per PP at 20°C ambient)
0	PPM300-3-A-100/480	480 V	100 A	100% (100 A)
1	PPM300-3-A-80/690	690 V	80 A	100% (80 A)
2	PPM300-3-W-140/690	690 V	140 A	100% (140 A)
3	PPM300-3-W-150/480	480 V	150 A	100% (150 A)
4	PPM300-3-A-100/480HC	480 V	100 A	100% (100 A)
5	PPM300-4-A-100/480	480 V	100 A	100% (100 A)
6	ADF P100-100/480	480 V	100 A	100% (100 A)
7	ADF P100-70/480	480 V	70 A	100% (70 A)
8	Reserved	-	-	-
9	PPM300-3-A-100/480HCB	480 V	100 A	100% (100 A)
10	PPM300-3-W-150/480HCB	480 V	150 A	100% (150 A)
11	PPM300v2-3-A-120/480	480 V	120 A	139% (166 A)
12	PPM300v2-3-A-90/690	690 V	90 A	111% (99 A)

13	PPM300v2-3-A-110/480-UL	480 V	110 A	100% (110 A)
14	PPM300v2-3-A-90/600-UL	600 V	90 A	100% (90 A)
15	ADF P100N-100/415	415 V	100 A	100% (100 A)
16	PPM300v2-3-A-130/480-OEM	480 V	130 A	100% (130 A)
17	PPM300v2-3-A-90/690-OEM	690 V	90 A	100% (90 A)
18	ADF P100v2-90/690	690 V	90 A	111% (99 A)
19	ADF P100v2-70/480	480 V	70 A	100% (70 A)
20	ADF P100v2-100/480	480 V	100 A	167% (167 A)
21	ADF P100v2-130/480	480 V	130 A	135% (175 A)
22	PPM300v2-3-W-150/480	480 V	150 A	100% (150 A)
23	PPM300v2-3-W-140/690	690 V	140 A	100% (140 A)
24	PPM300v2B-3-A-50/480	480 V	50 A	150% (75 A)
25	PPM300v2B-3-A-75/480	480 V	75 A	133% (99 A)
26	PPM300v2B-3-A-90/480	480 V	90 A	138% (124 A)
27	PPM300v2B-3-A-120/480	480 V	120 A	133% (159 A)
28	PPM300v2B-3-A-150/480	480 V	150 A	100% (150 A)
29	ADF P100v2B-50/480	480 V	50 A	150% (75 A)
30	ADF P100v2B-75/480	480 V	75 A	133% (99 A)
31	ADF P100v2B-90/480	480 V	90 A	138% (124 A)
32	ADF P100v2B-120/480	480 V	120 A	133% (159 A)
33	ADF P100v2B-150/480	480 V	150 A	100% (150 A)
34	PPM300v3-3-A-78/690	690 V	78 A	100% (78 A)
35	PPM300v3-3-A-130/480	480 V	130 A	100% (130 A)

The system is limited to 50 A of maximum output current per module unless a valid *Model key* is specified. See the description of *Model key* below (Section 4.3.12) for more information.

4.3.2 PP-module configuration

The standard system supports up to three PP-modules in total through the three PP-module sockets on the base of the control computer.

If the PP-module type is set to ADF P100, this setting is forced to 1 PP-module.

The following configurations are available: **No PP-modules**, **1 PP-module**, **2 PP-modules** or **3 PP-modules**.

4.3.3 PP-module configuration extender

Some variants of the SCC2 are fitted with an extender card that allows it to control up to six PP-modules in total. The extender card adds three extra PP-module sockets above the three standard sockets.

The following configurations are available for the extender: **No PP-modules**, **1 PP-module**, **2 PP-modules** or **3 PP-modules**.

This function is activated using a license key.

4.3.4 PP-module current limitation

This setting allows the maximum output current of the PP-module type to be scaled down using a percentage. For example, on a system with two PPM300v2-3-A-120/480 installed, setting the current limitation to 75% would limit the total output current of the system to 180 A.

If a license key for Overload mode has been entered, the value can be set higher than 100% for some module types. The system can then be operated at a rated power higher than the nameplate. This is only possible in an environment where the ambient temperature is at 20°C. Please refer to Table 7: Power module types for more information.

4.3.5 Nominal system voltage

This setting defines the nominal system voltage to which the system is connected. The available range of the value is defined by the module type.

For 480V modules, this can be set between **208 V** and **480 V**.

For 600V modules, this can be set between **208 V** and **600 V**.

For 690V modules, this can be set between **208 V** and **690 V**.

4.3.6 System frequency

This setting defines the nominal system frequency on the grid to which the system is connected and can be either **50 Hz** or **60 Hz**.

4.3.7 CT connection

The current transducers of the system can be connected either as **Closed-loop**, **Open-loop**, or **No CT connected**.

In closed-loop, the CTs measure the line current, i.e. the sum of the load current and the ADF compensation current.

In open-loop, only the load current is measured by the CTs.

Refer to the Hardware Manual for more information about CT connection.

Selecting *No CT connected* is meant for systems that use the Sensorless Control feature without having any CTs installed.

4.3.8 CT ratio

This setting defines the value of the primary side of the CTs. The secondary side is assumed to be 5 A.

The primary value can be set between **50 A** and **50000 A**.

Refer to the Hardware Manual for more information about CT selection.

4.3.9 Invert CT polarity

This setting inverts the polarity of the measured CT current. This can be useful in cases where all CTs have been connected the wrong way such that all three are 180 degrees out of phase and physically correcting the mistake is difficult.

This setting can be either: **Invert** or **Do not invert**.

4.3.10 Number of parallel systems

When operating systems in parallel using open-loop CT measurement, without multi-master bus, this setting is used to define the number of systems working in parallel.

NOTE When operating systems in parallel using the multi-master bus, this setting is irrelevant. The total number of power modules on the bus is automatically determined via the bus at every given moment.
--

This can be set from a **Single system** up to **16 systems in parallel**.

4.3.11 Grounding system

This can be set to either **TN/TT** or **IT** depending on how the system has been grounded.

TN/TT means the system has a direct connection to earth.

IT means that the system has no direct connection to earth.

The grounding systems are defined in IEC 60364.

4.3.12 Model key

The model key is typically entered during production of a system and sets the module type and unlocks the full output current of the module. The system can be operated without a Model key, but the output current is then locked to a maximum of 50 A per module.

The model key is unique to each SCC2 and is based on the SCC2 identifier. See Section 3.1.1 for information on how to obtain the SCC2 identifier.

This key should only be changed if the system is upgraded or if a SCC2 is repurposed or replaced. Also, if the system is updated from a software older than 1.4.8, a model key must be entered.

If an invalid model key has been entered, or if it is blank, a warning icon (⚠) will be shown next to the field after restart.

4.3.13 License key #1-4

For systems that has been delivered with license key activated options, up to four license keys can be entered. License keys are locked to a particular SCC2 control computer using the unique SCC2 identifier. See Section 3.1.1 for information on how to obtain the SCC2 identifier.

If an invalid license key has been entered, a warning icon (⚠) will be shown next to the field after restart.

4.3.14 Reset default settings

When saving the system setup, you can choose to reset defaults settings for configuration and compensation. This can be useful to ensure that the system has no old lingering settings when performing a commissioning.

4.4 Evaluate the system diagnostics

After the system has restarted, the diagnostics window (Figure 9) will appear in the WUI.

The diagnostics consists of two series of automated tests that both need to be completed successfully for the system to enter normal operation. The first series is performed with the system in a stopped state. This mainly concerns measurements such as verifying phase order, phase mapping and voltage levels. The second series will start the system and run it at idle for 30 seconds. This is to verify basic system operation. If any of the tests in the first series fail, the runtime tests will not be performed.

If any of the diagnostic tests fail, *FAILED* will be written in red at the top of the window.

For each failed diagnostic test, an action to rectify the problem is suggested.

Turn off the system, correct the problem and start it up again to rerun the diagnostics. The system will remain in diagnostics mode on subsequent restarts until all tests have been passed successfully.

If diagnostic code 56 *Detect CT current* fails, an override button will be presented in the diagnostics window (see figure below). Failing this diagnostic code means that the phase order and mapping of the CT current cannot be checked since the amplitude of the signal is too low. The CT current in RMS must be above $0.034 * \text{CT primary}$. So, for 600/5 CT, above $0.034 * 600 \text{ A} = 21 \text{ A}$. Click the *Override CT-current threshold check* button followed by *Restart system* to rerun the diagnostics without evaluating the CT current.

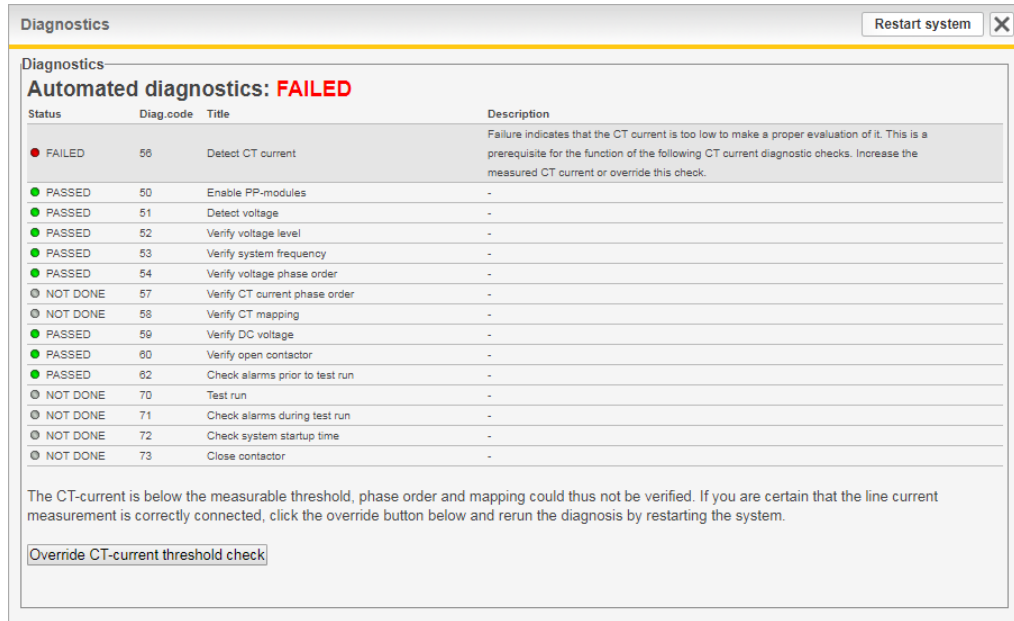



Figure 8: Diagnostics window – with override current threshold check

A complete list of all diagnostic codes is available in Section 7.2.2.



ATTENTION: After running the unit, there is residual voltage in the DC capacitors even after turning the unit completely off. Follow the instructions in the Hardware Manual before commencing any work in the unit after a failed diagnostic attempt.

If all diagnostic tests succeed, *PASSED* is written in green at the top of the window. The system will enter normal operation upon restart. Press the *Restart system* button to proceed.

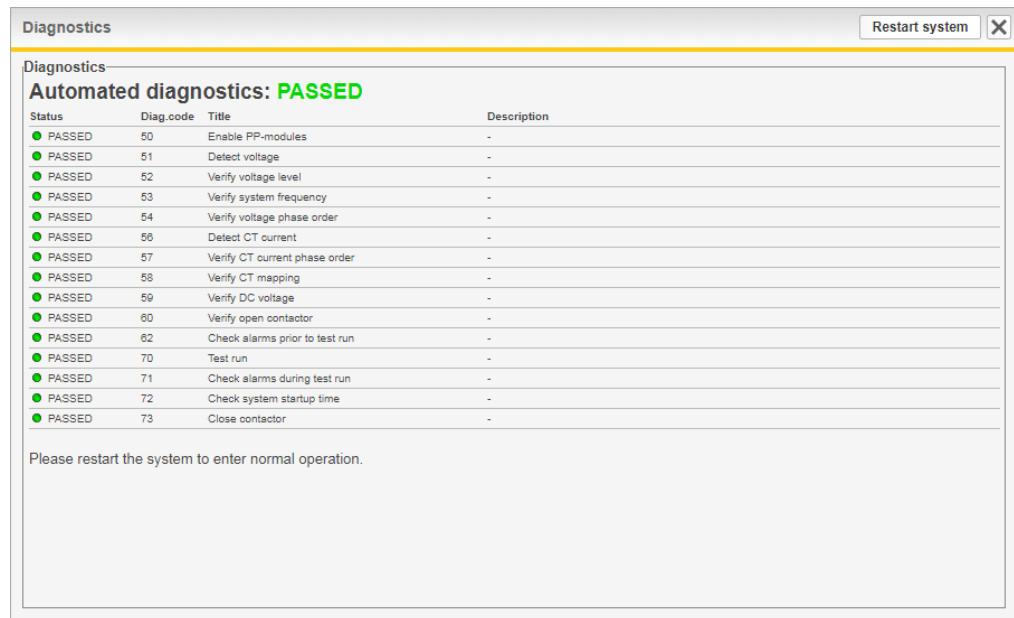

Figure 9: Diagnostics window

4.5 Perform final system configuration

With the system and installation-specific configuration now verified, it is time to configure everything else. This includes configuring compensation settings, network settings and digital input and output settings. This is described in Section 5.

After everything has been configured, please verify the system performance using a power quality instrument. Adjust the compensation settings if needed. The commissioning is now finished.

5 Configuration

5.1 Configuration settings



The *Configuration settings window* allows configuration of the non-commissioning settings to be performed.

The *Reset defaults* button will reset all settings except for time and date to default values.

Figure 10: Configuration settings window

5.1.1 Date and time

This sets the time and date of the system's real-time clock.

Date is represented as **YYYY-MM-DD** and time as **HH:MM** (24-hour format).

5.1.2 Language

This sets the language of the ADF dashboard. Available languages are: **English**, **Swedish**, **German** and **Chinese**. The system must be restarted for a new language setting to take effect.

5.1.3 Temperature unit

This sets the temperature unit to be used when showing temperatures.

The setting can be either **Celsius** or **Fahrenheit**.

5.1.4 Autostart on boot

When enabled, the system will automatically start operation after the set delay following system power-up and a completed pre-charge sequence.

This can be set to either, **Disabled**, **Instant start**, **10 seconds delay**, **20 seconds delay**, **30 seconds delay**, **40 seconds delay**, **50 seconds delay** or **60 seconds delay**.

5.1.5 Autorestart on alarm

When enabled, the system will automatically attempt to acknowledge and restart after an alarm when the trigger condition is no longer active. The function supports up to 10 restarts in one hour, if this is exceeded, no more automatic restarts will be performed, and the alarm must be manually acknowledged.

The setting can be either **Enabled** or **Disabled**.

5.1.6 Standby function

With the standby function, the ADF can be automatically put in standby mode (stopped) during periods of low load current. This can help save energy and increase the lifetime of the ADF components.

The setting can be either **Enabled** or **Disabled**.

NOTE The standby function has been redesigned in revision 2.0.0.
A software update to 2.0.0 or later will reset the standby function settings.

5.1.7 Standby wake-up level

This sets the level for when the standby function should start the system. It is defined as a percentage of the maximum current the CT is rated for, which is assumed to be the primary part of the CT ratio, i.e. 5000 A in case of a 5000/5 CT. In cases where summation CTs are used, this should be the resulting primary rating after the summation CTs. The level is compared to the load current in the fundamental, $I_{load,fund}$, to decide if the ADF should start.

Hovering the mouse pointer above the text will display the live value of $I_{load,fund}$, in percent. Since this is what the entered start/stop levels are compared against, it is useful when tuning the standby function.

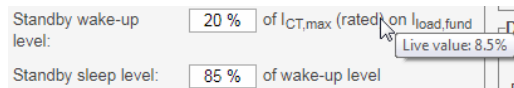

Figure 11: Displaying live value of $I_{load,fund}$ in percent

In multi-master mode, the master node will decide when standby should be entered and exited. Since any node on the bus can become master, the same standby settings should be used on all nodes on the bus.

NOTE The standby settings are not automatically replicated across the nodes on the multi-master bus, this must be done manually.

For example, a setting of 20% on a system with 5000/5 CTs will make the system start when the fundamental component of the load current reaches 1000 A.

The setting is defined from **0%** to **100%**.

5.1.8 Standby sleep level

This sets the level for when the standby function should put the system in to standby mode. It is defined as a percentage of the *Standby wake-up level*, so if the ADF should start at 1000 A seen on the fundamental component of the load current, a setting of 85% will make the filter go in to standby mode at 850 A.

This setting is defined from **0%** to **95%**.

5.1.9 Standby wake-up delay

This sets for how long $I_{load,fund}$ must be above *Standby wake-up level*, when in standby mode, before the system is automatically started.

The setting is defined from **0** seconds to **300** seconds.

5.1.10 Standby sleep delay

This sets for how long $I_{load,fund}$ must be below *Standby sleep level*, when in operation, before the system is automatically put in standby mode.

The setting is defined from **5** seconds to **300** seconds.

5.1.11 Resonance limit

Each harmonic enabled in the Compensation settings is monitored for resonance by looking at the voltage harmonic in each frequency.

If the amplitude of a voltage harmonic exceeds the *Resonance limit setting*, the harmonic in question will be stopped for one hour. After one hour has passed, the harmonic will be restarted.

The *Resonance limit setting* is defined as a percentage of the voltage amplitude in the fundamental frequency and is can be set from **1%** to **100%**.

5.1.12 HMI default view

This sets the default measurement view to be shown in the HMI at startup. (Only valid for old style HMI2, not for HMI3)

A list of the available views can be found in Table 20 on Page 56.

5.1.13 Digital outputs

The system is equipped with two relay outputs accessible on the X11 terminal of the system. One is a dedicated alarm output and one, OUT1, is user-configurable.

Physically the relays are of 250 V / 5 A type and are Normally-Open when the system is powered off.

5.1.13.1 Alarm output relay

The alarm output relay is activated if any alarm condition is triggered and will remain active until it has been acknowledged or the system has been restarted. This can be used for external monitoring of the system. The current alarm relay status is shown with a (0) or (1) icon right next to Alarm output. (1) means that the relay is closed, and (0) that it is open.

The alarm relay logic can be set to either Normally-Open (**NO**) or Normally-Closed (**NC**) and minimum activation time can be configured from **1** to **255** seconds. The activation of the alarm relay will stay on for a minimum of the configured time.

5.1.13.2 User configurable relay

The user-programmable digital output relay OUT1 can be used for monitoring the system status externally. The relay logic can be set to either Normally-Open (**NO**) or Normally-Closed (**NC**) and the activation function can be programmed for this output relay. The current OUT1 relay status is shown with a (0) or (1) icon next to the output. (1) means that the relay is closed, and (0) that it is open.

The activation function for OUT1 can be set to one or more of the alarms, warnings or system states listed in Table 21. Hold down the Ctrl key to select/unselect multiple items in the list. The output will activate if one or more of the selected items are active.

NOTE	The function of the configurable relay OUT1 has been redesigned in revision 2.0.0. A software update to 2.0.0 or later will reset any previous OUT1 setting.
-------------	--

To avoid short pulses, the output will stay activated for at least one second.

5.1.14 Digital inputs

Digital inputs *IN1*, *IN2* and *IN3* are user-configurable and can be used to operate the system. The current input status is shown with a (0) or (1) icon next to each input. (1) means that the input is high, and (0) that it is low.

The inputs are available on the X11 terminal of the system.

All digital inputs are of optically-coupled 24 V_{DC} types and the logic can be set to either **Active-Low** or **Active-High**. Each input can be programmed to trigger one the following events:

- **Trigger alarm** – Triggers the external alarm.
- **Start system**– Triggers a system start command.
- **Stop system** – Triggers a system stop command.
- **Acknowledge alarm** – Acknowledges all alarms.
- **Use secondary compensation set** – Secondary set of compensation settings will be used when active.
- **Start/stop system** – Controls the filter operation using a single digital input. The filter will start when the input transitions to the set trigger level and will stop when it transitions to the opposite level. When the filter has reached its target state, no more start/stop commands will be generated until the next transition of the input. This makes it possible to start/stop the filter manually in between transitions.



ATTENTION: Do not mix digital input and Modbus TCP control commands to the same function. Doing this will lead to unpredictable behavior.

For example, do not start and stop the system using both digital input and Modbus.

5.2 Compensation settings



This window allows configuration of all settings that concerns the compensation which is to be performed by the system.

Using the dropdown menu in the title bar of the window, a second set of compensation settings can be defined. If changes have been made to the primary set, save them by clicking *Apply* before editing the secondary set, as changes otherwise will be lost.

The *Reset defaults* button will reset all parameters in the currently shown compensation set to default values.

NOTE During multi-master parallel operation, the master will determine and override the compensation set used in all online and running systems.

Switching between the two sets of compensation settings is done using the digital inputs or using Modbus TCP. See Section 5.1.14 for more information.

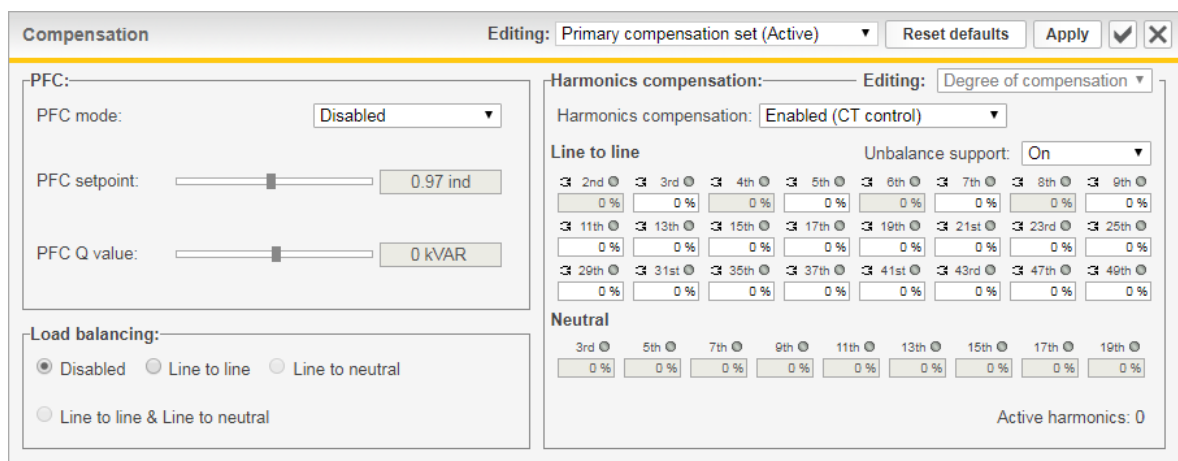

Figure 12: Compensation settings window

In parallel operation, the compensation settings may only be changed on the current master node. The slave nodes are automatically synchronized by the master node. Opening the compensation settings window on a slave node will yield the following result:

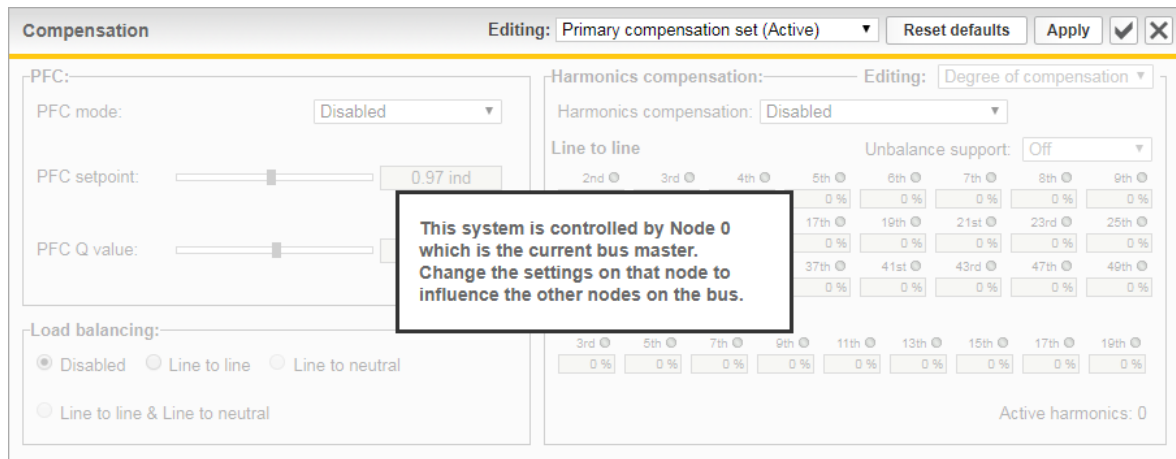

Figure 13: Compensation settings window locked

5.2.1 PFC mode

Power factor correction can be configured as **Disabled**, **Static**, **Dynamic**, **Dynamic (inductive)** or **Dynamic (capacitive)**.

In static mode, a fixed amount of capacitive or inductive reactive power can be generated as specified in the *PFC Q* setting. The maximum value of the *PFC Q* setting is defined by the rated current output of the system in relation to the nominal system voltage.

In dynamic mode, the system will control the power factor measured on the CTs to the value specified in the *PFC setpoint* setting. This value can be set between **0.5 inductive** and **0.5 capacitive**.

The inductive and capacitive dynamic modes lock the direction of compensation to either capacitive or inductive. For example, in *PFC dynamic* mode with the *PFC setpoint* set to 0.9 inductive and the power factor without compensation is 0.99 inductive, the system would worsen the situation by outputting more inductive current. If instead the *PFC dynamic (capacitive)* mode had been set, the system would only compensate from for example 0.80 (ind) to 0.90 (ind), not from 0.99 (ind) to 0.9 (ind).

5.2.2 Load balancing

The load balancing setting can be configured as **Disabled**, **Line to Line**, **Line to Neutral**** or both **Line to Line and Line to Neutral****.

When Line to Line load balancing is enabled, the system will compensate for imbalances between phases.

In Line to Neutral, the compensation will take place between phases and the neutral connection.

5.2.3 Harmonics compensation

The harmonics compensation can be set to **Disabled**, **Enabled (CT control)**, **Enabled (Sensorless Control)**.

NOTE Sensorless Control is a license key activated option. If you wish to use this feature, please contact Comsys.

The degree of compensation is configurable in percent for each harmonic with 0% being no compensation and 100% being complete elimination of the harmonic.

The harmonics are divided in to two categories, line to line harmonics and line to neutral** harmonics.

Harmonics that can be compensated line to line are: 2nd, 3rd, 4th, 5th, 6th, 7th, 8th, 9th, 11th, 13th, 15th, 17th, 19th, 21st, 23rd, 25th, 29th, 31st, 35th, 37th, 41st, 43rd, 47th and 49th.

And line to neutral*: 3rd, 5th, 7th, 9th, 11th, 13th, 15th, 17th and 19th.

NOTE Even order harmonics support is a license key activated option. If you wish to use this feature, please contact Comsys.

For PP-module types **PPM300v2B-3-A-50/480**, **PPM300v2B-3-A-75/480**, **PPM300v2B-3-A-90/480**, **ADF P100v2B-50/480**, **ADF P100v2B-75/480** and **ADF P100v2B-90/480**, the total number of harmonics enabled at once is limited to 26 for standard CT-based control and 6 when using Sensorless Control. There is no limitation for other module types.

Support for unbalanced harmonics can be set to **On** or **Off**. This setting is useful in cases where a harmonic is unevenly distributed across the phases. When support for unbalanced harmonics is enabled, each line to line harmonic will consume two processing units instead of one. The unbalance support can be individually turned off per harmonic by using clicking on the small arrow icon by each harmonic. If a double arrow is shown (↔) it means unbalance support is on for that harmonic, a single arrow (↘) means that unbalance support is disabled.

When open-loop is configured, phase angles (in units of degrees, 0-359 degrees) and amplitude (in units of %, 60%-140%) calibration parameters can be entered for each harmonic. This may be necessary in some situations to obtain ideal compensation results. Use an external measurement device to find the calibration parameters.

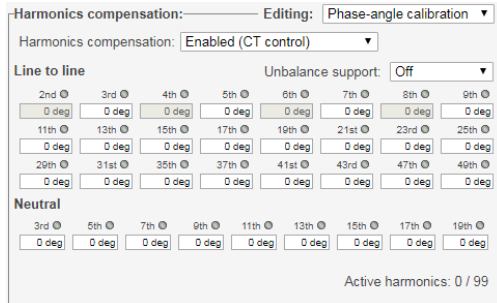

Figure 14: Phase-angle calibration in compensation window

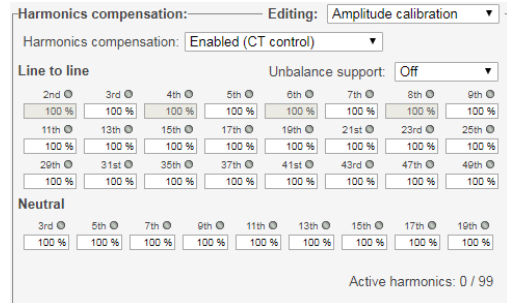

Figure 15: Amplitude calibration in compensation window

*) Available in 4-wire systems only.

5.3 Network settings



This window allows configuration of the TCP/IP networking parameters, multi-master settings for parallel system operation and hostname settings of the system.

The reset defaults button will reset all network settings to default values.

All changes require the system to be restarted before taking effect.

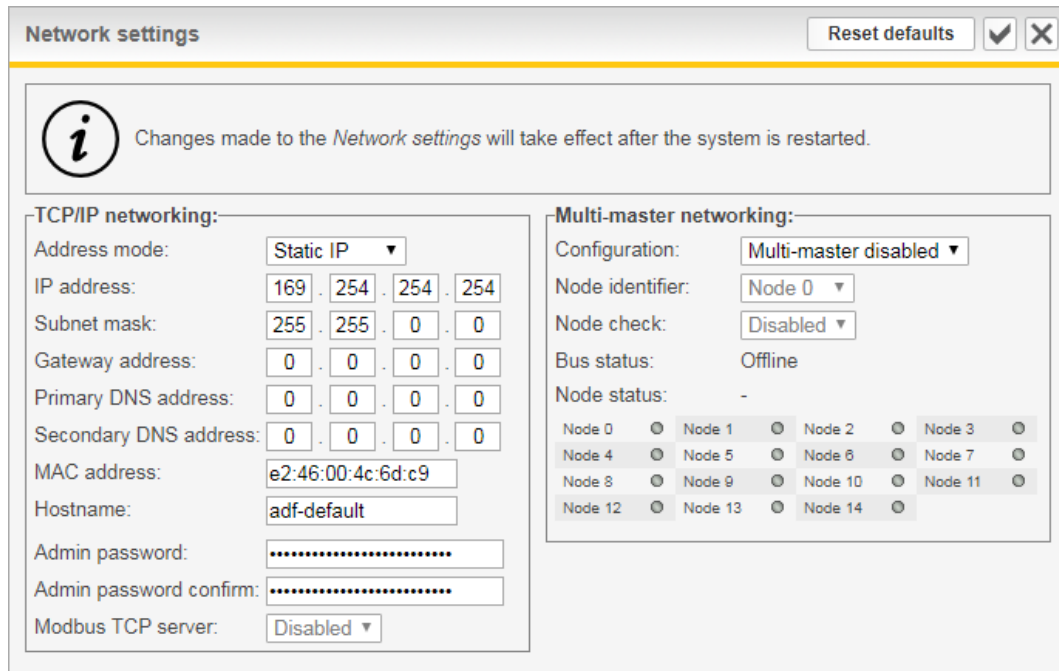

Figure 16: Network settings window

5.3.1 TCP/IP networking settings

5.3.1.1 Address mode

This setting defines how the IP settings should be acquired and can be set to either **Static IP** or **Dynamic IP**.

In Static IP mode, the entered IP address, Subnet mask and Gateway address will be used by the system.

In Dynamic IP mode, the IP settings will be acquired using DHCP. The IP settings that has been acquired using DHCP is shown under the *About menu* of the HMI.

5.3.1.2 IP address

This setting defines the IP address that the system should use when configured as Static IP.

The default value is **169.254.254.254** and is a *link-local* IP address.

The link-local IP address greatly reduces the need to reconfigure the client PC when connecting directly to the ADF. When a client PC is set to obtain an IP address automatically, it will assign itself a link-local address without any configuration necessary.

Please see Section 3.1.3 for more information on how to connect to the ADF.

If the ADF is to be connected to a network, the link-local address range must not be used.

NOTE Care should be taken not to assign the system an address that is already in use on the network as this will cause trouble accessing both the ADF and the other host.

In case an invalid address has been entered, it is possible to reset the network configuration to default values under the *System admin menu* of the HMI. See Section 7.3.4 or Section 9.10 for more information.

5.3.1.3 Subnet mask

This setting defines the subnet mask that the system should use when configured as Static IP.

The default value is **255.255.0.0**.

5.3.1.4 Gateway address

This setting defines the gateway address that the system should use when configured as Static IP. Unless the system should be accessible through a gateway, this field can safely be left blank.

The default value is **0.0.0.0**.

5.3.1.5 Primary and secondary DNS addresses

These addresses are currently not used and can be left blank.

5.3.1.6 MAC address

This setting defines the MAC address to be used by the system.

The default value is automatically generated based on a unique system identifier and exists in the *locally-assigned* address range.

5.3.1.7 Hostname

This setting defines the hostname of the system and can be up to 20 characters long and may only contain characters a-z, A-Z, 0-9, underscore (_) and hyphen (-).

This is used for identifying the system internally, such as in log files.

The default value is **adf-default**.

5.3.1.8 Admin Password

This setting allows the user to change the administrator password used when logging in to the ADF Dashboard. The same password must be written identical twice in both boxes for the system to accept the change.

When the administrator password is set, changing settings in the HMI will be locked. It is however still possible to start and stop the system using the HMI.

The HMI can be unlocked with the Unlock setting, see Section 7.3.4 for more information.

NOTE Do not forget the changed password. If the changed password is forgotten, Comsys must be contacted to restore the system.

5.3.2 Modbus TCP server

This setting controls if the built-in Modbus TCP server should be enabled or disabled.

Please see 'Appendix A Modbus TCP server' for more information.

NOTE Modbus TCP server support is a license key activated option. If you wish to use this feature, please contact Comsys.
--

5.3.3 Multi-master networking settings

The following section describes the multi-master parallel system feature. The bus requires a hardware bus adapter that is sold as an option. Please refer to the relevant Hardware manual for instructions on how to connect the multi-master bus.

NOTE All systems on the same multi-master bus must have the same software revision. Mixing software revisions may lead to unpredictable behavior and should be avoided.

5.3.3.1 Configuration

This setting enables the multi-master feature and sets the number of nodes to expect on the bus. Up to 15 nodes can be operated in parallel.

Available choices are: **Multi-master disabled, 2 nodes on bus, 3 nodes on bus, ..., 15 nodes on bus.**

The default setting is **Multi-master disabled.**

5.3.3.2 Node identifier

The node identifier is the node’s address when communicating on the bus.

This must be unique for each system that will participate in parallel operation.

Available choices are: **Node 0, Node 1, Node 2, ..., Node 14.**

The default setting is **Node 0.**

5.3.3.3 Node check

The idea behind this function is to avoid conditions where the bus is split in to two independent sides. Each side would act independently and potentially start competing against each other.

When enabled, the system will require at least half of the total number of nodes configured to be online at every given moment. Should half or less than half of the total number of nodes be online, the compensation will be disabled, and the warning *MMerr / MM error* will be visible in the HMI display.

In some situations, this function should be disabled, for example when systems are taken out of operation on the bus so that the function is preventing operation.

5.3.3.4 Bus status

Here the status of the multi-master bus is presented. The status consists of whether the node is online or offline and which node it considers to be its master node.

5.3.3.5 Node status

Here the status of the other nodes on the bus is presented. Displayed is the number of online nodes and the number of running nodes.

Online nodes are indicated in green in the table.

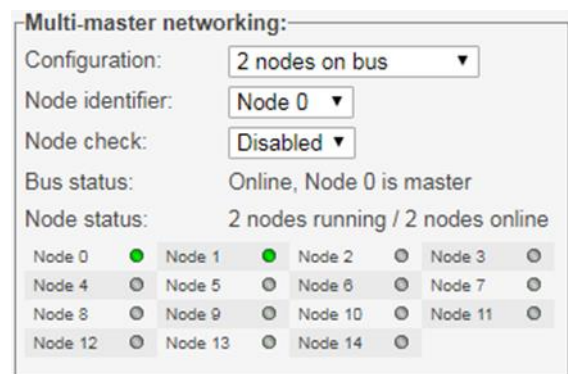

Figure 17: Multi-master Networking Settings

5.4 Import and export settings

The software supports import and export of settings. This makes it possible to store the entire list of settings for archival purposes or to clone settings between systems.

When cloning settings between systems, keep in mind that some settings are unique for each system, such as license/model keys, IP-address, multi-master node identifier etc., and



Figure 18: Import and export settings buttons

therefore may need to be changed after importing settings from another system.

5.4.1 Exporting settings

To export the settings, click the *Export settings* button in the *About* window. (See Figure 18)

You will now be prompted to download a file with the name `adf_settings_X.txt`, where the X is the serial number of the SCC2 (when applicable).

The file contains plain text key/value pairs describing the settings in the internal format used by the SCC2. At the top is a header containing various information about the system that exported the settings file.

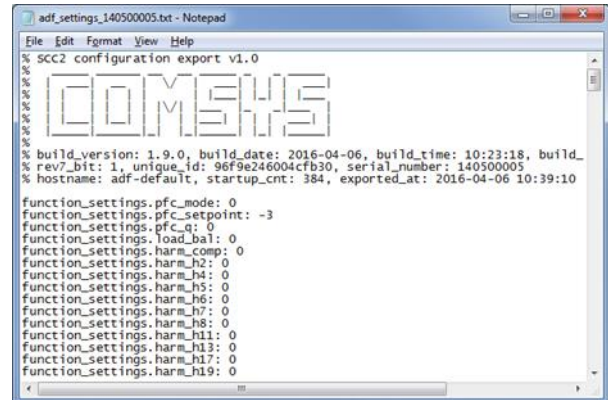

```

adf_settings_14050005.txt - Notepad
File Edit Format View Help
% SCC2 configuration export v1.0
%
% COMSYS
%
% build_version: 1.9.0, build_date: 2016-04-06, build_time: 10:23:18, build_rev7_bit: 1, unique_id: 96f9e24604cfb30, serial_number: 14050005
% hostname: adf-default, startup_cnt: 384, exported_at: 2016-04-06 10:39:10
function_settings.pfc_mode: 0
function_settings.pfc_setpoint: -3
function_settings.pfc_q: 0
function_settings.load_bal: 0
function_settings.harm_comp: 0
function_settings.harm_h2: 0
function_settings.harm_h4: 0
function_settings.harm_h5: 0
function_settings.harm_h6: 0
function_settings.harm_h7: 0
function_settings.harm_h8: 0
function_settings.harm_h11: 0
function_settings.harm_h13: 0
function_settings.harm_h17: 0
function_settings.harm_h19: 0

```

Figure 19: Exported settings file

It's not recommended that the file is manually edited, with the following two exceptions:

1. User comments may be added after the header (i.e. after the last line starting with a %-sign). Each user comment line must begin with a %-sign as the very first character.
2. Key/value lines may be deleted to customize which settings the file should contain. Settings that does not exist in the file will not be changed when importing.

5.4.2 Importing settings

To import a settings file, click the *Update software / import settings* button in the *About* window. (See Figure 18)

Click *Browse/Select File* button, select a settings file from the file system and click *Open*.

You will now be presented with the window shown in Figure 20. Choose which groups to import by checking/unchecking the checkbox for each group and then click *Import selected settings* to import them.

If either *System setup*, *License/model key* or *Network settings* groups has been selected, you must restart the system before the changes take effect. If *System setup* or *License/model key* has been selected, *System setup mode* will be forced after restart.

After importing the settings, you will be presented with the window shown in Figure 21. Here you will see the number of setting items that were imported, and the *Reset computer* button can be clicked to restart the SCC2.

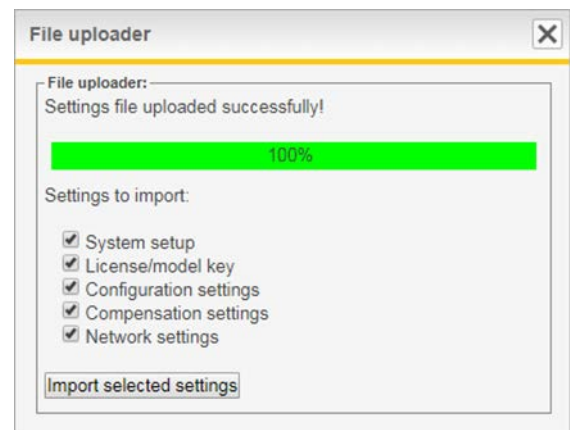

Figure 20: Importing settings file

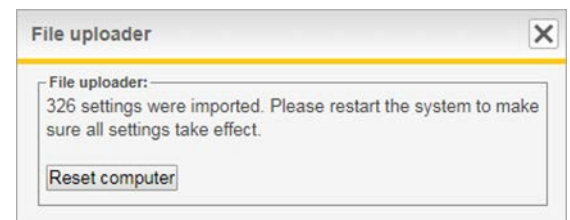

Figure 21: Settings file imported

6 Operation and monitoring

This section describes how to operate and monitor the ADF P100/P300.

6.1 System states and Events



The *Events window* gives insight in to the system events, alarms and warnings, both as a chronological list and tables for alarms and warnings.

See Table 21 for a complete list of all system events, alarms and warnings.

If the system detects an issue in its operation, it will trigger an alarm. This alarm will stop the system and a log file will be generated.

Warnings are triggered in very much the same way as alarms, but do not stop the system. This indicates an issue that are not as urgent as an alarm, but the presence of warnings should still be investigated.

By default, only active alarms and warnings are shown. By clicking on the buttons *Show all alarms* or *Show all warnings*, all items can be shown.

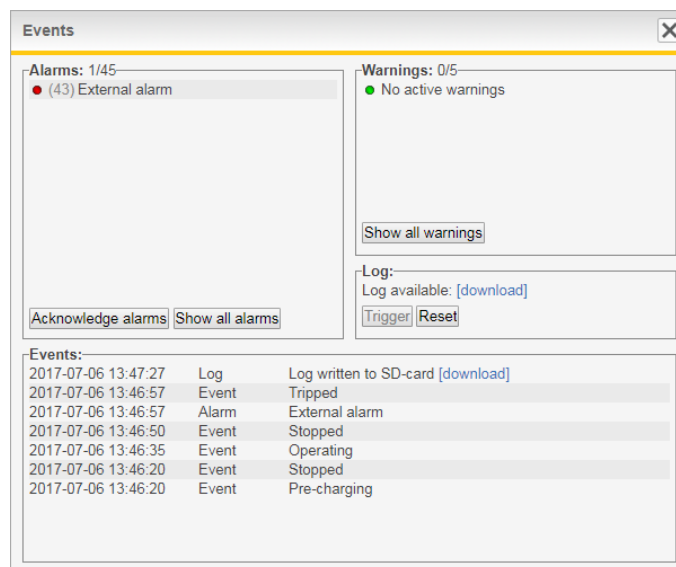

Figure 22: The Events window

6.1.1 Acknowledging alarms

To restart the system after an alarm, it must be acknowledged. This is done using the *Acknowledge alarm* button in the *Events window*. If the alarm conditions are no longer present, it will be possible to start the system again.

Acknowledging the alarms will automatically reset the log data recorder.

For persistent alarm conditions, the alarm will immediately be triggered again upon acknowledgement. Doing a hard restart using the switch in the door or the *PIB* can be necessary in this case.

For frequently occurring alarms that cannot be explained by external factors, thorough investigation of the root cause is recommended to avoid system damage.

Please refer to Table 21 for more information about the alarms.

The system can be configured to automatically restart after an alarm, providing that the fault condition has ceased. Please see Section 5.1.5 for more information.

6.1.2 Log data recorder

The log function continuously records system data in such a way that if an alarm is triggered, it contains data from both before and after the alarm. The log file can be downloaded directly in the Event window but is also accessible on the SD-card.

The log file is a valuable tool for system troubleshooting and should be downloaded and attached when requesting support.

Besides triggering automatically when an alarm becomes active, it can also be manually triggered and reset. This is useful when requesting support on a running system, as the recorded data will show how the ADF was operating.

To trigger the log data recorder when running, click *Trigger*. It will take up to half a minute to store the log file on to the SD-card, after this the file can be downloaded. To reset the log data recorder, click *Reset*. Manually triggered log files will automatically be reset after 5 minutes, however they will still be available for download on the SD-card, through the chronological list.

NOTE When manually triggering the log, especially when the ADF is in operation, ensure that it is reset immediately after the log file has been downloaded. If the log is already triggered and the ADF trips on an alarm, the alarm event will not be recorded.

NOTE Do not manually reset the log function if an alarm is active. The log will be immediately triggered again and will no longer contain the moment when the ADF tripped on the alarm. The old log file can however still be downloaded from the SD-card using the chronological list.

6.1.3 States and events

After the commissioning procedure has been completed, the system will always start in *Normal operation mode* when energized. In this mode, the system can be in one of the states shown in Figure 23 below.

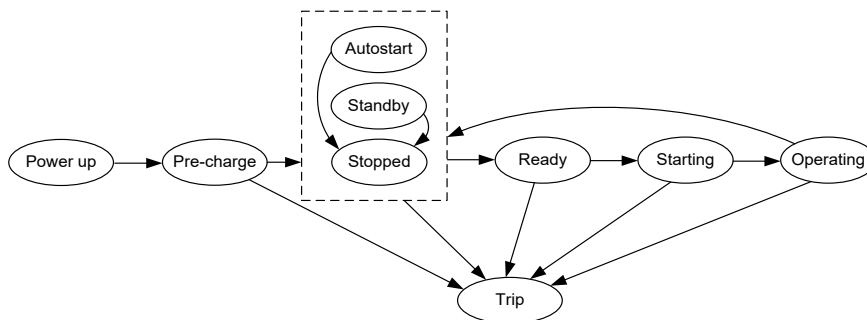

Figure 23: System states

- **State: Pre-charging**

In this state, the DC-bus is charged to allow the system to be started. When it is fully charged, the system will go to the *Stopped* state.

- **State: Stopped**

In this state, the system can be started and will continue to the *Ready* state when such a command is received. The contactor(s) are commanded to be open in this state.

- **State: Autostart**

In this state, the system is about to autostart according to the setting found in the *Configuration settings window*.

- **State: Standby**

In this state, the system is waiting for the load current start threshold to be reached before the system is automatically started.

- **State: Ready**

In this state, the contactor(s) will close and the system will go to the *Starting* state.

- **State: Starting**

In this state, the system is being started up and the compensation is ramped up to its final value. The *Operating* state is then entered.

- **State: Operating**

In this state, the system is in full operation and performing the desired compensation. Upon receiving a stop command, the system will go to the *Stopped* state.

- **State: Tripped**

In this state, the system has stopped on an alarm which is preventing the system from being able to be started. When all alarms have been acknowledged, the system will go to the *Pre-charge* state.

6.2 Starting and stopping



When the DC-bus is fully charged the system is ready to be started.

Start and stop commands can be generated:

- Manually – Buttons in the toolbar can be used to start and stop the system.
- By automatic start – A start command can be automatically generated following power up and after a programmable delay without user intervention.
- By automatic restart – When enabled, the system will automatically attempt to restart after alarms.
- By digital input – The digital inputs can be used to generate start and stop commands.
- By Modbus TCP – Modbus can be used to generate start and stop commands.

6.3 Measurement



The *Measurement window* shows power quality data which can be of interest when evaluating the performance of the system. The following parameters are shown:

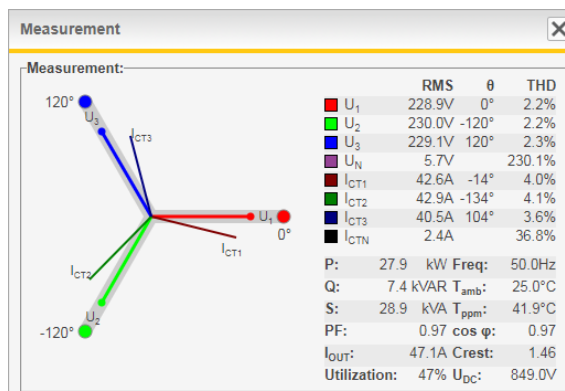

Figure 24: The Measurement window

Table 8: Overview of measurement window functionality

Parameter	Description
U1, U2, U3 and UN	Phase voltages (RMS values in V, phase angles and THD)
I1, I2, I3 and IN	CT currents (RMS values in A, phase angles and THD) *
P	Active power in kW *
Q	Reactive power in kVAR (+ = inductive, - = capacitive) *
S	Apparent power in kVA *
PF	Power factor *
I_{ADF}	Output current in A_{RMS}
Utilization	System utilization shown in percent
Freq	Fundamental frequency in Hz
T_{amb}	Ambient air temperature in C° / F°
T_{ppm}	Power module temperature in C° / F°
$\cos \varphi$	Cos phi, displacement power factor *
Crest	Crest factor of voltage
U_{dc}	Power module DC-link voltage in V

* Only available when CTs are connected

6.4 Waveform view



The *Waveform view window* can show one of the following waveforms:

- CT current (A)
- Compensation current (A)
- Phase voltage (V)

The waveforms are updated every other second.

6.4.1 CT current

This view shows the CT current which can be either the line or the load current depending on if the CTs are connected as closed-loop or open-loop.

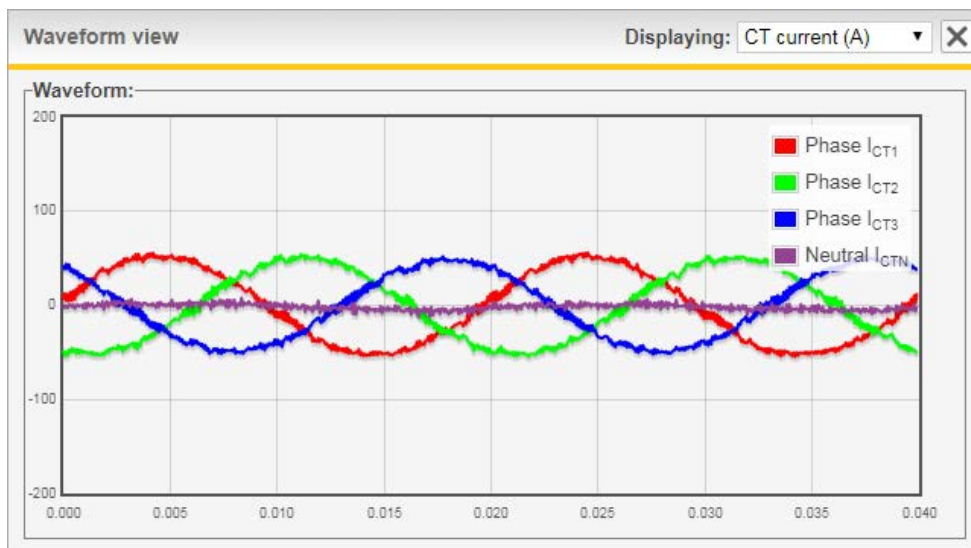

Figure 25: Waveform view window showing CT current

6.4.2 Compensation current

This view shows the ADF compensation current, as measured internally in the ADF.

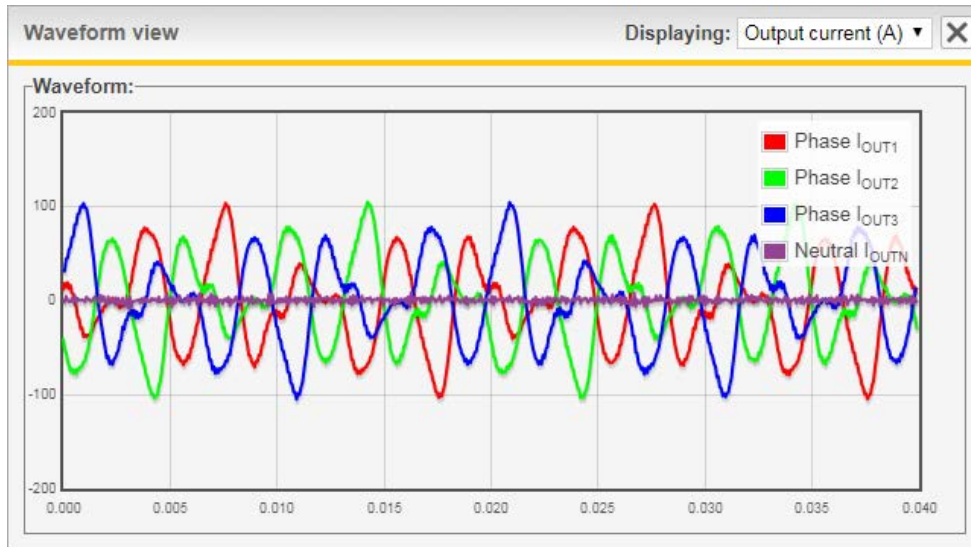

Figure 26: Waveform view window showing Compensation current

6.4.3 Phase voltage

This view shows the phase voltage, as measured by the ADF.

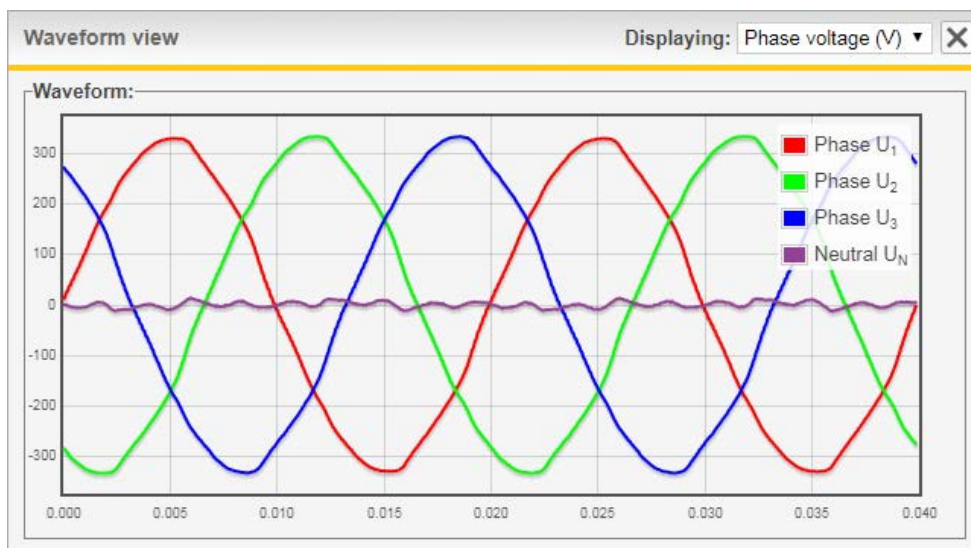

Figure 27: Waveform view window showing Phase voltage

6.5 Spectrum view



The *Spectrum view window* can show one of the following spectrums:

- CT current (A_{rms})
- Compensation current (A_{rms})
- Phase voltage (V_{rms})

Spectrums are updated every other second.

The *Auto scale* button makes it possible to toggle between two modes of scaling, either *All* which will scale based on the amplitudes of both the fundamental and the harmonics, or *Harm* which will scale based on only the amplitudes of the harmonics.

Hover on a bar in the spectrum view to show the amplitude:

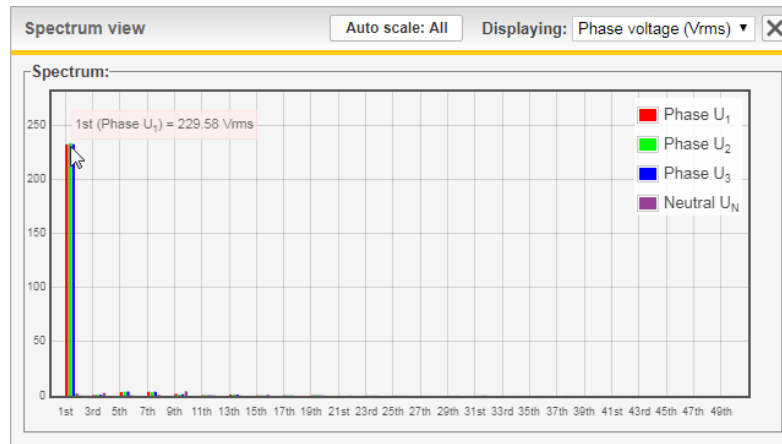

Figure 28: Hover function in the spectrum view window

6.5.1 CT current

This view shows the CT current which can be either the line or the load current depending on if the CTs are connected as closed-loop or open-loop.

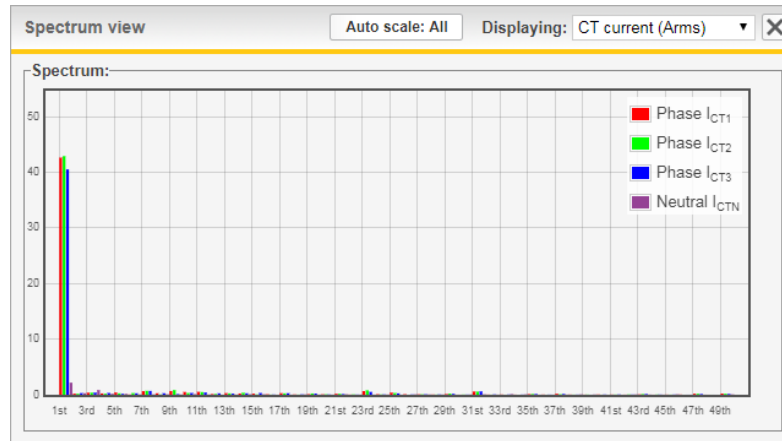

Figure 29: Spectrum view window showing CT current

6.5.2 Compensation current

This view shows the ADF compensation current, as measured internally in the ADF.

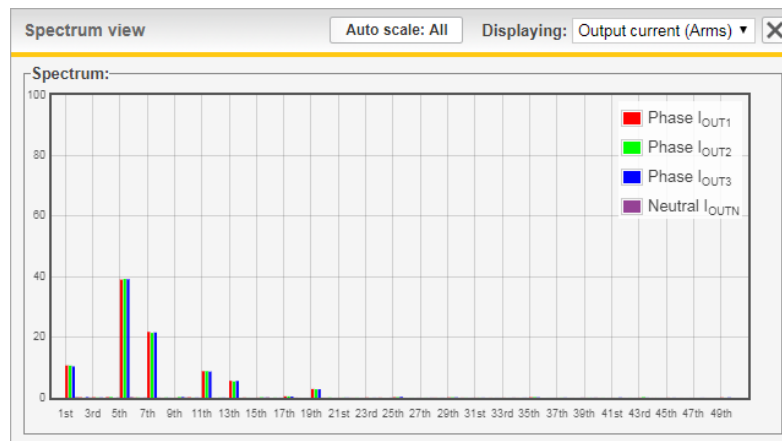

Figure 30: Spectrum view window showing Output current

6.5.3 Phase voltage

This view shows the phase voltage, as measured by the ADF.

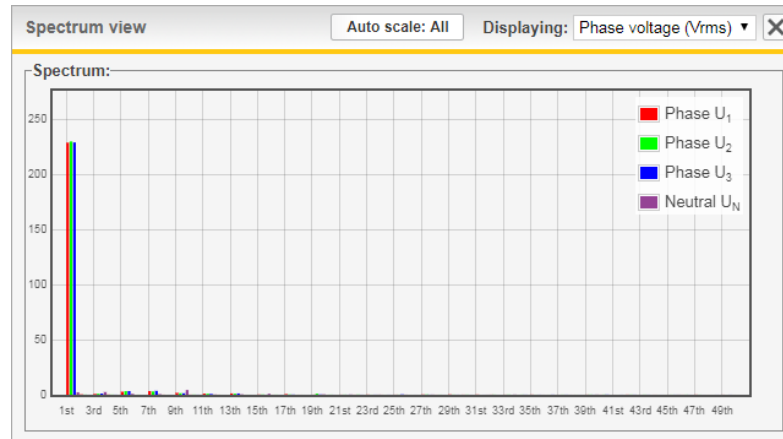

Figure 31: Spectrum view window showing Phase voltage

6.6 Software update

The software in both the SCC2 as well as the HMI3 can be updated directly in the WUI. A Comsys-provided software image is uploaded to the SCC2 and depending on the detected file type, either the SCC2 or HMI3 can be flashed after user confirmation of this action. A checksum prevents damaged or invalid images from being flashed.

The software is usually distributed in a ZIP file and needs to be extracted to get the '.img' file for the SCC2 or a '.hex' file for the HMI3.

To begin, open the *File uploader* by clicking the *Update software / Import settings* button in the *About* window.

1. Click *Browse/Choose File* in the *File uploader* window.

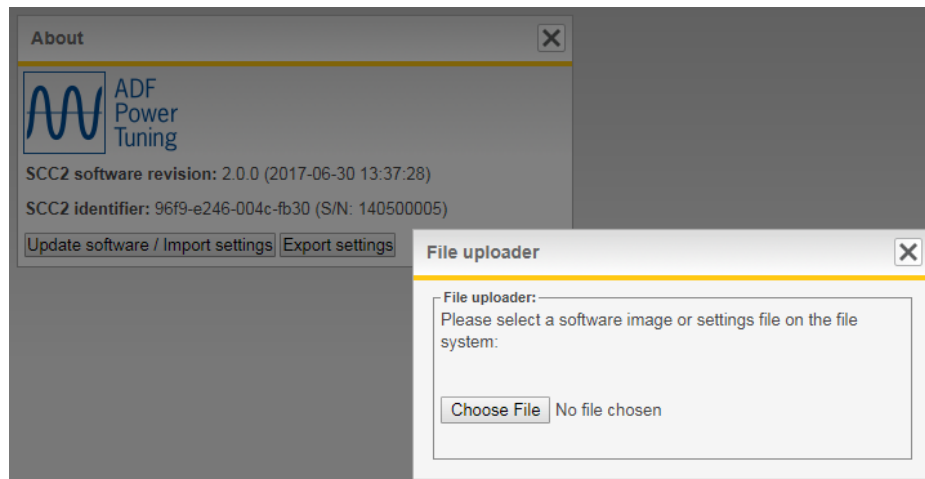

Figure 32: Update software

2. Navigate to the SCC2 or HMI3 software image file supplied by Comsys and click *Open*. The progress bar will indicate upload progress.

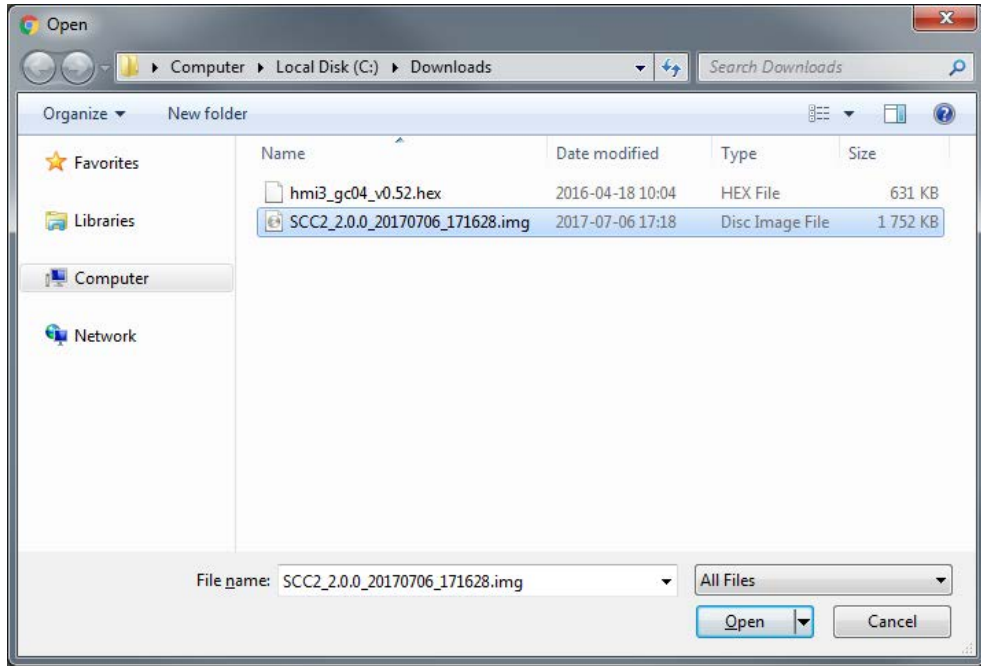

Figure 33: Selecting a file for software update

3. If the uploaded software image was a SCC2 image, please continue to Section 6.6.1. If it was a HMI3 software image, continue to Section 6.6.2.

6.6.1 Updating SCC2

1. If a SCC2 software image was uploaded, you will be presented with the following screen. Verify the software revision and click *Write to flash* to begin the flash update procedure.

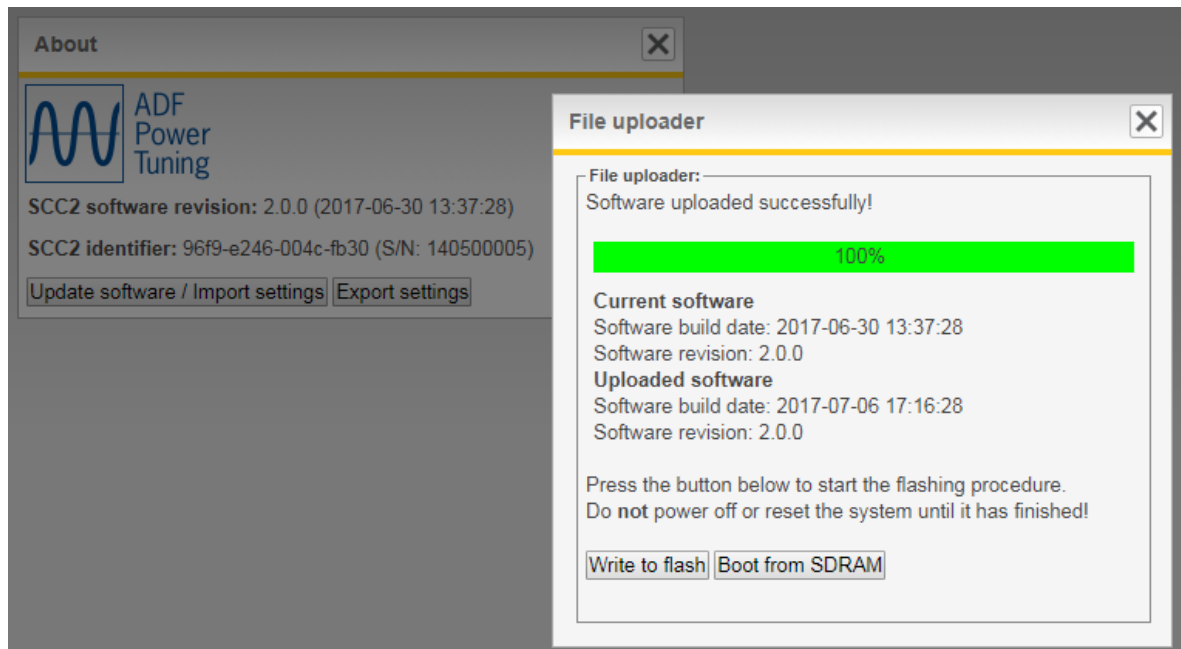

Figure 34: Confirm SCC2 software update

2. The flashing process is now running, do not turn off the system! The progress bar will display the status of the flashing.

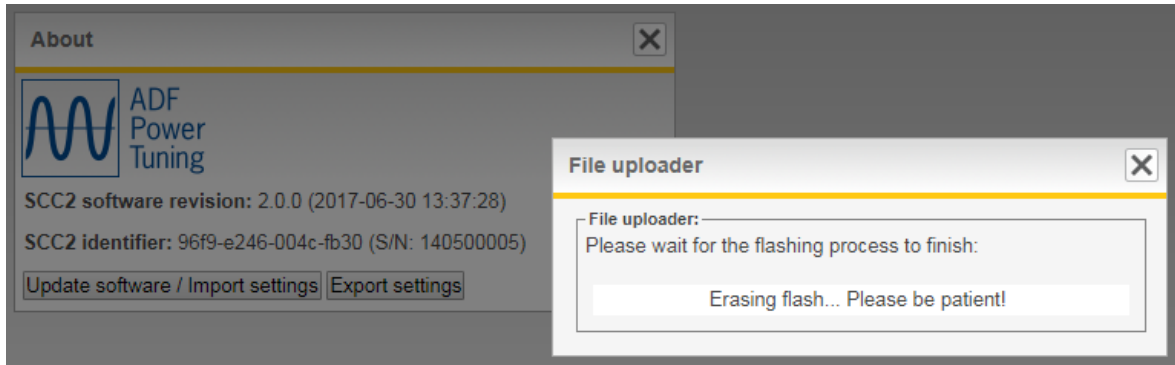

Figure 35: Flashing SCC2

NOTE Should contact with the WUI be lost during the flash update procedure, but the ADF still has power, wait 5 minutes and then restart the ADF using the switch in the door or PIB.

3. The flashing procedure has been successful when the progress bar reaches 100%. Click *Reset computer* to load the new software.

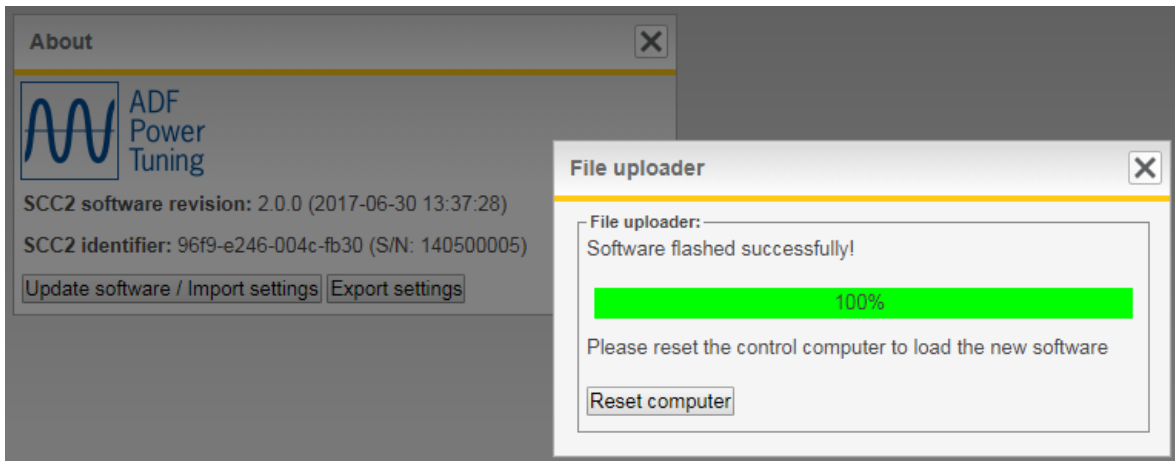

Figure 36: SCC2 software update complete

NOTE If the ADF is powered off during the flash update procedure, the factory default software image will be booted on the next start.

ATTENTION: It is imperative that the new software image is an approved Comsys software image suitable for the application at hand.

Using any other software image may cause malfunction and risk for the equipment as well as for personnel.

Warranty is void if non-official software images are used.

6.6.2 Updating HMI3

1. If a HMI3 software image was uploaded, you will be presented with the screen in Figure 37. **Ensure stable voltage supply** and click *Update HMI3 software* to begin the flash update procedure.

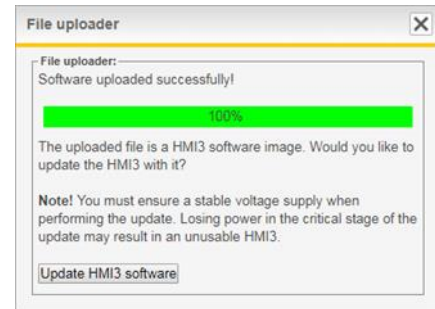

Figure 37: Confirm HMI3 software update

2. Wait until presented with the screen shown in Figure 38. The HMI3 was updated successfully, you can now close the window and use the system normally.

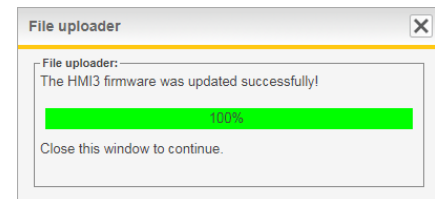

Figure 38: HMI3 software update complete

7 Human Machine Interface (HMI2)

The system can be configured, commissioned and operated through the HMI2 user interface found in the cabinet door. Please note: The HMI2 is obsolete; new systems are delivered with HMI3.

7.1 HMI overview

The HMI-based user interface is an easy way of setting basic parameters, controlling the operational modes as well as monitoring measurements and system status during operation. The HMI unit is fitted with an LCD text display and four keys for entry of commands and navigating menus as shown in Figure 39 below.

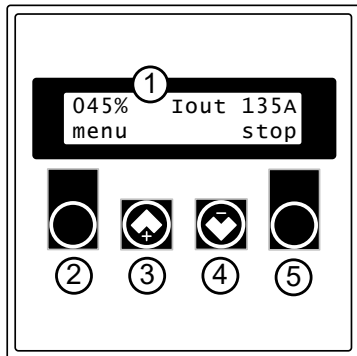

Figure 39: HMI overview

Table 9: HMI description

No	Description
1	LCD display
2	Left soft key – triggers the action shown in the lower left part of the display
3	Up arrow key – used for navigating measurement views, menus and entering values (increase of value)
4	Down arrow key used for navigating measurement views, menus and entering values (decrease of value)
5	Right soft key – triggers the action shown in the lower right part of the display

7.2 Commissioning using the HMI

While it is recommended to commission the system using the WUI, the procedure can also be performed using the HMI in cases where bringing a computer is difficult.

The main commissioning procedure described in Section 4 should be followed in conjunction in this section.

7.2.1 System setup

Having forced the system in to *System setup mode* by holding down the HMI plus button while turning Switch in the door, *setup* is written in the lower right corner of the HMI. Press the rightmost HMI button to enter the setup menu.

By navigating up and down, all system setup parameters except for the model key and license keys can be configured. Please see Table 10 below for a complete list of the available parameters and their values.

When the setup is complete, perform *Save & restart* to save the settings and enter diagnostics.

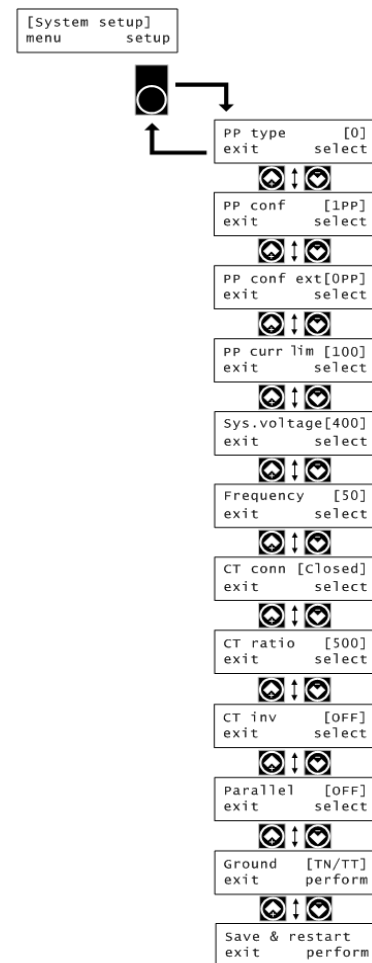

Figure 40: System setup in HMI

Table 10: Setup menu

Parameter	HMI name	Default	Description
PP-module type	PP type	0	Selects the PP-module type in the system. Value: 0-23 . For more information about the PP-module types, see Section 4.3.1.
PP-module configuration	PP conf	1PP	Number of PP-modules connected to the primary PP-sockets at the base of the control computer. Value: 0PP...3PP
PP-module configuration (extender)**	PP conf ext	0PP	Number of PP-modules connected to the PP-sockets on the extender board. ** Value: 0PP...3PP
PP-module current limitation	PP curr lim	100	Specifies a limitation factor in percent that is used for limiting the total output current of the system. Value: 0%...100% Can be set higher than 100% for certain PPM types if Overload mode is active. Please see Section 4.3.4 for more information.
Nominal system voltage	Sys.voltage	400	Specifies nominal system voltage: 480 V module: 208V...480V 600 V module: 480V...600V 690 V module: 480V...690V
System frequency	Frequency	50	Specifies nominal system frequency Value: 50Hz or 60Hz
CT connection	CT conn	Closed	External class 1.0 CT location: CL = Closed-loop (grid side) OL = Open-loop (load side) NONE = No CT installed
CT ratio	CT ratio	500	CT primary transforming ratio (secondary fixed to 5 A): Value: 50A...50000A
Invert CT polarity	CT invert	OFF	Specifies if the polarity of the CT connection is inverted: OFF = Do nothing ON = Invert the CT polarity
Number of parallel systems	Parallel	OFF	Specifies the number of systems connected in parallel when operating in open-loop: OFF = No systems connected in parallel 2...16 = Number of systems connected in parallel NOTE: This setting is obsolete if multi-master parallel systems function is used!
Grounding system	Ground	TN/TT	Specifies the grounding system according to IEC 60364: TN/TT = System has a direct connection to earth IT = System has no direct connection to earth
Save and restart	Save & restart	-	Save, restart the system and enter diagnostics

***) Available as an option

7.2.2 Evaluating system diagnostics

Restarting the system after changing the system setup will make the system enter diagnostics mode.

Please wait for the system to finish the diagnostics.

The diagnostics should take no longer than 5 minutes, if the HMI displays *Diag: Running...* longer than that, please power off the system and try again.

If all diagnostic tests succeeded, *Diag: Passed all* will be written on the HMI.

Press *continue* to restart the system and enter normal operation.

If any of the diagnostic tests failed, *Diag: Failed X* will be written on the HMI, where X is a diagnostic code. Press *next* repeatedly to view all diagnostic codes. Look them up in Table 11 below and attempt to rectify the problem based on the suggested action. Then start the system back up again to rerun the diagnostics.

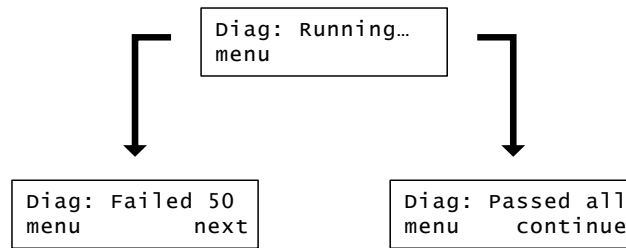

Figure 41: Diagnostics in the HMI

Table 11: Diagnostic codes

Diagnostic code	Title	Suggested action if failed
50	Enable PP-modules	Failure indicates wrong number of power modules. Make sure that the number of specified power modules corresponds to the number of installed power modules. Also check that the connectors, PP1-PP3, are properly inserted to the SCC2 control computer.
51	Detect voltage	Failure indicates that the system voltage is too low to make a proper evaluation of it. This is a prerequisite for the function of the following system voltage diagnostics. Please make sure the voltage measurement is connected properly.
52	Verify voltage level	Failure indicates wrong system voltage. Make sure that the specified system voltage is correct. Check that all phases are properly connected to the power terminals.
53	Verify system frequency	Failure indicates wrong system frequency. Make sure that the specified system frequency, 50 Hz or 60 Hz, is correct.
54	Verify voltage phase order	Failure indicates wrong phase order on the power terminals. Make sure that the voltage of phase A lies ahead of phase B, and the voltage of phase B lies ahead of phase C.
56	Detect CT current	Failure indicates that the CT current is too low to make a proper evaluation of it. This is a prerequisite for the function of the following CT current diagnostic checks. Increase the measured CT current or override this check. The CT current in RMS must be above $0.034 * CT \text{ primary}$. So, for 600/5 CT, above $0.034 * 600 \text{ A} = 21 \text{ A}$.
57	Verify CT current phase order	Failure indicates wrong phase order of the measured load current. That means wrong CT connection. Check the CT connection and make sure that the current of phase A lies ahead of phase B, and the current of phase B lies ahead of phase C.
58	Verify CT mapping	Failure indicates incorrect mapping of CT current to system voltage. The CT current vector of each phase should be within +/- 90 degrees from the voltage vector of that phase.
59	Verify DC voltage	Failure indicates that the DC voltage level, required to activate the contactor(s), has not been reached. Check the fuses of the pre-charging circuit.
60	Verify open contactor	Failure indicates malfunction in the contactor circuit. Either the contactors are hardwired to close immediately upon power up or the contactor status signal is read as closed when the contactors in fact are open.
62	Check alarms prior to test run	Failure indicates that an alarm condition is active before trying to start run time tests of the system.
70	Test run	Failure indicates that the system was prevented from completing its test run. Maybe it was manually stopped by user.
71	Check alarms during test run	Failure indicates that one or more alarms were triggered while running the system. Check the protection window for further evaluation.
72	Check system startup time	Failure indicates that the system startup exceeded the specified startup time. This can be a sign of the main fuses being broken/not inserted. Check the fuses and try again.
73	Close contactor	Failure indicates that the contactor(s) didn't respond correctly to the activation command.

7.3 Configuration using the HMI

All configuration parameters except for the network settings can be changed using the HMI. Below is an overview of the menu structure.

NOTE When operating systems in parallel using the multi-master bus, the compensation settings must be changed on the master node. The settings made here are automatically synchronized with the slave nodes.

NOTE To change settings via the HMI when an administrator password has been set (see Section 5.3.1.8), it is required to enter an Unlock code. Please see Section 7.3.4 for more information.

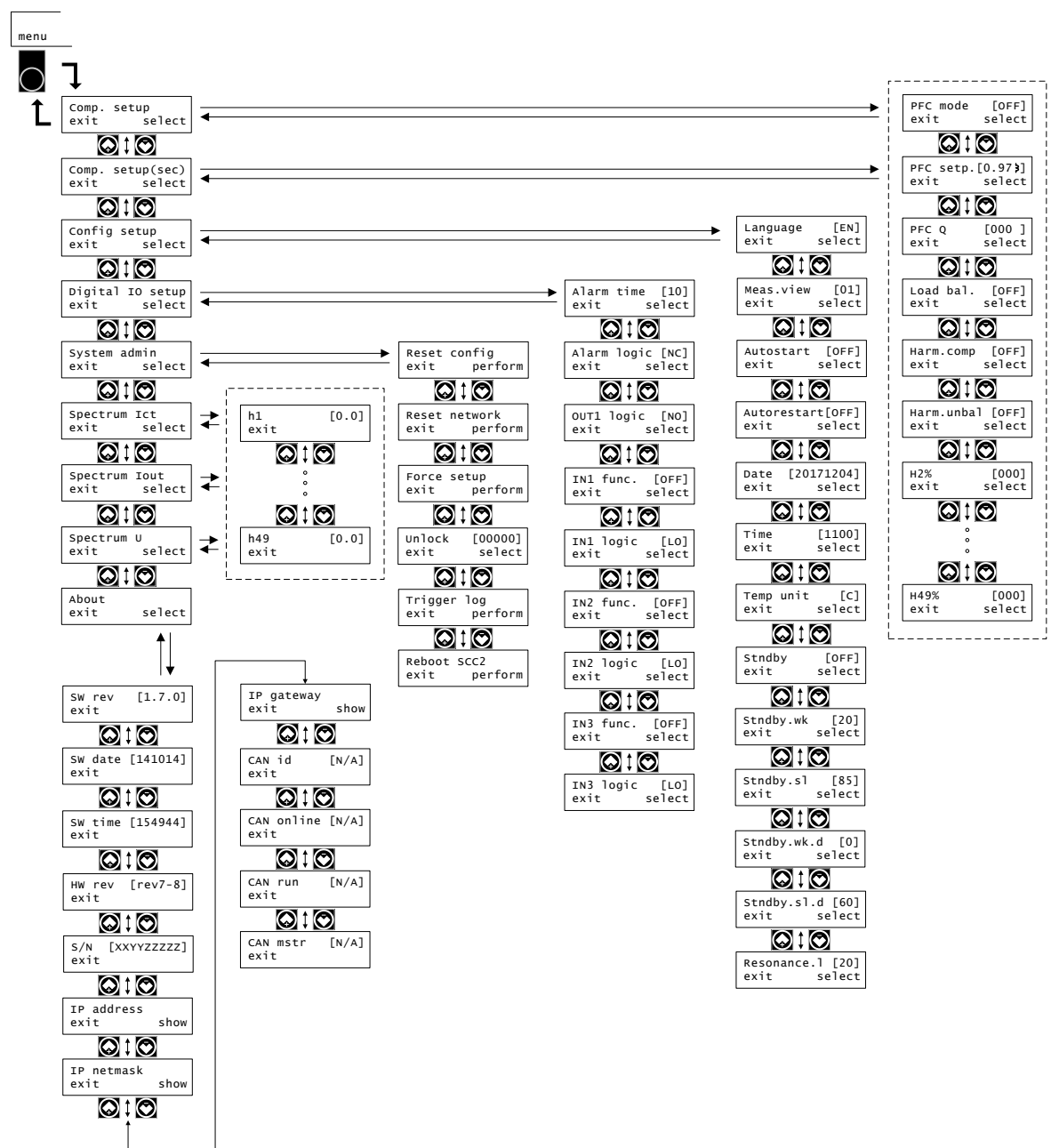

Figure 42: HMI menu structure

7.3.1 Compensation setup menu

The *Compensation setup menu* and *Compensation setup menu (secondary)* allows configuration of all parameters described in Section 5.2.

NOTE	The concept of a harmonic processing unit budget described in Section 5.2 is important to understand as the HMI lack the clear feedback that is presented in the WUI when the budget is used up.
	This is however mainly a concern when operating a 4-wire system or when enabling the <i>Unbalanced harmonic support</i> setting as the budget cannot be fully used up otherwise.

Table 12: Compensation setup menu

Parameter	HMI name	Default	Description
PFC mode	PFC mode	OFF	Selects Power Factor Correction mode: OFF = Disabled, DYN = Dynamic compensation based on PFC setpoint, STAT = Fixed kVAR of reactive power, DYNI = Dynamic compensation in inductive direction only, DYnc = Dynamic compensation in capacitive direction only.
PFC setpoint	PFC setp.	0,97 ind	Setpoint for Power factor in DYN mode: Value: 0,5 inductive to 0,5 capacitive , step 0,01
PFC Q	PFC Q	0	Fixed reactive power in STAT mode. Value: MAX inductive ... 0 ... MAX capacitive* (rating of system), step 1 kVAR
Load Balancing	Load bal.	OFF	Selects load balancing mode: OFF = disabled, LL = Line to Line, LN = Line to Neutral**, LL&LN = Line to Line and Line to Neutral**
Harmonic compensation	Harm.comp	OFF	Enables or disables harmonic compensation globally Value: OFF = Disabled, CT (Enabled with CT control), VOLT (Enabled with Sensorless Control) ****
Unbalanced harmonic support	Harm.unbal	OFF	Enables or disables support for unbalanced harmonics: OFF = Disabled, ON = Enabled
H2 ***	H2%	0	Degree of compensation: 0%...100%
H3	H3%	0	Degree of compensation: 0%...100%
H4 ***	H4%	0	Degree of compensation: 0%...100%
H5	H5%	0	Degree of compensation: 0%...100%
H6 ***	H6%	0	Degree of compensation: 0%...100%
H7	H7%	0	Degree of compensation: 0%...100%
H8 ***	H8%	0	Degree of compensation: 0%...100%
H9	H9%	0	Degree of compensation: 0%...100%
H11	H11%	0	Degree of compensation: 0%...100%
H13	H13%	0	Degree of compensation: 0%...100%
H15	H15%	0	Degree of compensation: 0%...100%
H17	H17%	0	Degree of compensation: 0%...100%
H19	H19%	0	Degree of compensation: 0%...100%
H21	H21%	0	Degree of compensation: 0%...100%
H23	H23%	0	Degree of compensation: 0%...100%
H25	H25%	0	Degree of compensation: 0%...100%
H29	H29%	0	Degree of compensation: 0%...100%
H31	H31%	0	Degree of compensation: 0%...100%
H35	H35%	0	Degree of compensation: 0%...100%
H37	H37%	0	Degree of compensation: 0%...100%
H41	H41%	0	Degree of compensation: 0%...100%
H43	H43%	0	Degree of compensation: 0%...100%
H47	H47%	0	Degree of compensation: 0%...100%
H49	H49%	0	Degree of compensation: 0%...100%
H3N **	H3N%	0	Degree of compensation: 0%...100%
H5N **	H5N%	0	Degree of compensation: 0%...100%
H7N **	H7N%	0	Degree of compensation: 0%...100%
H9N **	H9N%	0	Degree of compensation: 0%...100%

H11N **	H11N%	0	Degree of compensation: 0%...100%
H13N **	H13N%	0	Degree of compensation: 0%...100%
H15N **	H15N%	0	Degree of compensation: 0%...100%
H17N **	H17N%	0	Degree of compensation: 0%...100%
H19N **	H19N%	0	Degree of compensation: 0%...100%

*) The kVA rating of the system is stated in the technical specification. **) Available in 4-wire systems only. ***) Even harmonics available as an option. ****) Sensorless Control is available as an option, contact Comsys.

7.3.2 Configuration setup menu

The *Configuration setup menu* allows configuration of the settings described in Section 5.1.1 to Section 5.1.12.

Table 13: Config settings menu

Parameter	HMI name	Default	Description
Language	Language	EN	Selects the language for ADF Dashboard. Restart is required before the setting takes effect. Value: EN (English), SV (Swedish), DE (German) or ZH (Chinese)
Measurement view	Meas.view	1	Selects default HMI measurement view at startup Value: 1...14 (see Table 20)
Autostart	Autostart	OFF	Enable/Disable the autostart function: OFF = Autostart disabled INST = Autostart enabled with instant start 10, 20, ..., 60s = Autostart enabled with startup delay in seconds
Autorestart	Autorestart	OFF	Controls the autorestart function. Allows for a maximum of 10 restart attempts in an hour. OFF = Autorestart after alarm is disabled ON = Autorestart after alarm is enabled
Date	Date	2000-01-01	Sets the system date: YYYY-MM-DD
Time	Time	00:00	Sets the system time: HH:mm
Temp unit	Temp unit	C	Selects default temperature unit: Value: F (Fahrenheit) or C (Celsius)
Standby function	Stndby	OFF	Controls the standby function: OFF = Standby function is disabled ON = System will automatically start and stop depending on the load.
Standby wake-up threshold	Stndby.wk	20%	Controls the threshold over which the system will wake-up when in standby mode. This is defined as a percentage of the maximum rated CT current seen on the load current in fundamental frequency. Example: If the CT is 500/5 and the setting 20%, the filter will start when the load current in fundamental frequency is greater than $500 * 0.2 = 100$ A. Can be set between 0% and 100% .
Standby sleep threshold	Stndby.sl	85%	Controls the threshold under which the system will go to sleep when the standby function is enabled. This is defined as a percentage of the Standby wake-up threshold setting. Given a 500/5 CT ratio, a start threshold of 20% and a stop threshold of 85%, the filter will go in to standby mode when the load current in fundamental frequency goes below $500 * 0.2 * 0.85 = 85$ A. Can be set between 0% and 95% .
Standby wake-up delay	Stndby.wk.d	0 s	Sets for how long the wake-up threshold must be exceeded before the system is started when in standby mode. Can be set between 0 s and 300 s .
Standby sleep delay	Stndby.sl.d	60 s	Sets for how long the sleep threshold must be stayed under before the system is stopped and put in standby mode. Can be set between 5 s and 300 s .
Resonance limit	Resonance.l	20%	Sets the limit in voltage amplitude for each harmonic. When exceeded, the harmonic in question will be blocked for one hour. After one hour, the harmonic will again be activated. This is defined as a percentage of the voltage amplitude in the fundamental frequency. Can be set between 1% and 100% .

7.3.3 Digital IO setup menu

The *Digital IO setup menu* allows configuration of the alarm relay, the user-configurable relay as well as binding functions to the digital inputs. Please see Section 5.1.13 and Section 5.1.14 for more information.

Table 14: Alarms settings menu

Parameter	HMI name	Default	Description
Alarm relay min time	Alarm time	10	Sets Alarm relay minimum activation time Values: 1 ... 255 seconds
Alarm relay logic	Alarm logic	NC	Select Alarm relay logic * Values: NO (Normally Open), NC (Normally Closed)
Output OUT1 logic	OUT1 logic	NO	Select output OUT1 relay logic * Values: NO (Normally Open), NC (Normally Closed)
Digital IN1 function	IN1 func.	OFF	Selects digital IN1 function: OFF = Disabled, ALARM = Trigger external alarm, START = Start the system, STOP = Stop the system, ACK = Acknowledge the external alarm, SCOMP = Use secondary set of compensation settings, SRTSTP = Start/stop the system
Digital IN1 logic	IN1 logic	LO	Select input IN1 logic: Values: LO (Active Low), HI (Active High)
Digital IN2 function	IN2 func.	OFF	Selects digital IN2 function: OFF = Disabled, ALARM = Trigger external alarm, START = Start the system, STOP = Stop the system, ACK = Acknowledge the external alarm, SCOMP = Use secondary set of compensation settings, SRTSTP = Start/stop the system
Digital IN2 logic	IN2 logic	LO	Select input IN2 logic: Values: LO (Active Low), HI (Active High)
Digital IN3 function	IN3 func.	OFF	Selects digital IN3 function: OFF = Disabled, ALARM = Trigger external alarm, START = Start the system, STOP = Stop the system, ACK = Acknowledge the external alarm, SCOMP = Use secondary set of compensation settings, SRTSTP = Start/stop the system
Digital IN3 logic	IN3 logic	LO	Select input IN3 logic: Values: LO (Active Low), HI (Active High)

* All relays are physically normally-open when the system is turned off.

NOTE The OUT1 digital output function can no longer be configured using HMI2. Please use the WUI or upgrade to HMI3.

7.3.4 System admin menu

The *System admin menu* gives access to various system functions such as resetting system configuration to factory default values.

Table 15: Config settings menu

Parameter	HMI name	Description
Reset configuration and compensation settings	Reset config	Resets all configuration settings and compensation settings to default values.
Reset network settings	Reset network	Resets all network settings to default values. A system restart is necessary for the changes to take effect.
Force <i>System setup mode</i>	Force setup	Will force the system to enter <i>System setup mode</i> after restart.
Unlock HMI	Unlock	Unlocks the HMI when an administrator password is set. The unlock code is 61874 . Is automatically reset to 00000 after 10 minutes of HMI inactivity.
Trigger log	Trigger log	Triggers the creation of a log file. Only do this when instructed to do so by Comsys.
Reboot SCC2	Reboot SCC2	Restarts the SCC2 control computer.

7.3.5 Spectrum I_{CT}

Spectrum I_{CT} shows the CT current in each frequency from fundamental frequency up to the 49th harmonic. The result is the mean value of the three phases and the unit is A_{RMS}.

Table 16: Spectrum I_{CT} menu

Parameter	HMI name	Description
Fundamental component of the CT current	I _{ct} .h1	The amount of CT current in the fundamental frequency.
2 nd harmonic component of the CT current	I _{ct} .h2	The amount of CT current in the 2 nd harmonic.
...
49 th harmonic component of the CT current	I _{ct} .h49	The amount of CT current in the 49 th harmonic.

7.3.6 Spectrum I_{OUT}

Spectrum I_{OUT} shows the ADF output/compensation current in each frequency from fundamental frequency up to the 49th harmonic. The result is the mean value of the three phases and the unit is A_{RMS}.

Table 17: Spectrum I_{OUT} menu

Parameter	HMI name	Description
Fundamental component of the output current	I _{out} .h1	The amount of output current in the fundamental frequency.
2 nd harmonic component of the output current	I _{out} .h2	The amount of output current in the 2 nd harmonic.
...
49 th harmonic component of the output current	I _{out} .h49	The amount of output current in the 49 th harmonic.

7.3.7 Spectrum U

Spectrum U shows the voltage in each frequency from fundamental frequency up to the 49th harmonic. The result is the mean value of the three phases and the unit is V_{RMS}.

Table 18: Spectrum U menu

Parameter	HMI name	Description
Fundamental component of the phase voltage	U.h1	The amount of voltage in the fundamental frequency.
2 nd harmonic component of the phase voltage	U.h2	The amount of voltage in the 2 nd harmonic.
...
49 th harmonic component of the phase voltage	U.h49	The amount of voltage in the 49 th harmonic.

7.3.8 About menu

The *About menu* provides information about the software revision, serial number, IP settings and multi-master bus settings of the system.

Table 19: About menu

Parameter	HMI name	Description
Software revision	SW rev	Shows the revision of the running software.
Software build date	SW date	Shows the build date of the running software.
Software build time	SW time	Shows the build time of the running software.
Hardware revision	HW rev	Shows the hardware revision of the SCC2
Serial number	S/N	Shows the serial number of the SCC2
IP address	IP address	Shows the actual IP address of the system.
IP netmask	IP netmask	Shows the actual IP netmask of the system.
IP gateway address	IP gateway	Shows the actual IP gateway address of the system.

Multi-master node identifier	MM id	Shows the multi-master node identifier of this system.
Multi-master nodes online	MM online	Shows the number of nodes currently online on the bus.
Multi-master nodes running	MM run	Shows the number of nodes currently running on the bus.
Multi-master master node	MM mstr	Shows the current master node of the multi-master bus.

7.4 Operation using the HMI

7.4.1 Starting and stopping

When the system is in the *Stopped* or *Operating* state, start and stop of the system can be performed using the right-most soft key.

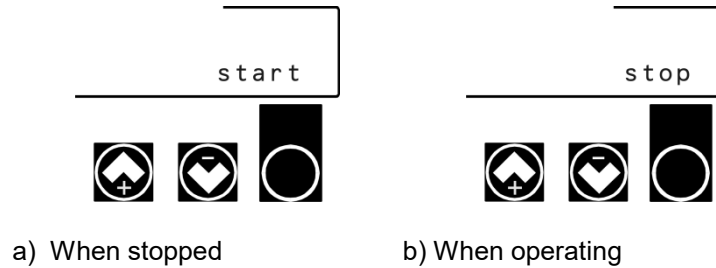

Figure 43: HMI LCD and keys in different operating states

7.4.2 Displaying measurement data

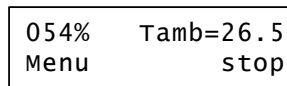

Figure 44: Display of measurement in HMI

When the system is in the *Stopped* or *Operating* state, measurement data is shown in the top row of the HMI. The seven measurement views can be navigated between using the HMI up and down buttons.

Table 20: Measurements views

Display	Parameters	Unit
1	Utilization% and RMS value of the CT current	A
2	Utilization% and RMS value of the Compensation current	A
3	Utilization% and RMS value of the line-to-line voltage	V
4	Utilization% and THD of phase voltage	%
5	Utilization% and THD of CT current	%
6	Utilization% and Active power (P) currently measured on the CT	kW
7	Utilization% and Reactive power (Q) currently measured on the CT	kVAR
8	Utilization% and Apparent power (S) currently measured on the CT	kVA
9	Utilization% and Power factor	-
10	Utilization% and Cos phi	-
11	Utilization% and Line frequency	Hz
12	Utilization% and Ambient cabinet temperature	°C/°F
13	Utilization% and Power module temperature	°C/°F
14	Utilization% and DC-bus capacitor voltage	V

7.4.3 Displaying alarms and warnings

Any active alarms will be shown instead of the measurement data on the top row of the HMI. Each alarm code will be stepped through and displayed for 2 seconds at a time. When it reaches the end, it will start over from the beginning. Before contacting support, please note down each alarm code before acknowledging the alarms using the *ACK* button.

The right-most button becomes *ACK* which is used to acknowledge all active alarm.

Non-critical issues are displayed as warnings. Warnings are shown in the HMI by toggling between the measurement data and the warning every other second. There is no immediate cause for concern when a warning is active but determining the root cause is recommended.

Alarm:05(ICT>hi)
Menu ACK

Figure 45: Alarm shown in HMI

Available alarms and warnings are shown in Table 21.

Table 21: Alarms, Warnings and States

Code	Alarm condition	Cause/Action
1	PP1 error OT	Overtemperature PPM#1. Check cooling.
2	PP1 error HB1	IGBT error phase 1 PPM#1
3	PP1 error HB2	IGBT error phase 2 PPM#1
4	PP1 error HB3	IGBT error phase 3 PPM#1
5	PP2 error OT	Overtemperature PPM#2. Check cooling.
6	PP2 error HB1	IGBT error phase 1 PPM#2
7	PP2 error HB2	IGBT error phase 2 PPM#2
8	PP2 error HB3	IGBT error phase 3 PPM#2
9	PP3 error OT	Overtemperature PPM#3. Check cooling.
10	PP3 error HB1	IGBT error phase 1 PPM#3
11	PP3 error HB2	IGBT error phase 2 PPM#3
12	PP3 error HB3	IGBT error phase 3 PPM#3
13	PP4 error OT	Overtemperature PPM#4. Check cooling.
14	PP4 error HB1	IGBT error phase 1 PPM#4
15	PP4 error HB2	IGBT error phase 2 PPM#4
16	PP4 error HB3	IGBT error phase 3 PPM#4
17	PP5 error OT	Overtemperature PPM#5. Check cooling.
18	PP5 error HB1	IGBT error phase 1 PPM#5
19	PP5 error HB2	IGBT error phase 2 PPM#5
20	PP5 error HB3	IGBT error phase 3 PPM#5
21	PP6 error OT	Overtemperature PPM#6. Check cooling.
22	PP6 error HB1	IGBT error phase 1 PPM#6
23	PP6 error HB2	IGBT error phase 2 PPM#6
24	PP6 error HB3	IGBT error phase 3 PPM#6
25	SCC2 supply error #1	Internal voltage supply error. Check SCC2 and PSU.
26	SCC2 supply error #2	Internal voltage supply error. Check SCC2 and PSU.
27	SCC2 supply error #3	Internal voltage supply error. Check SCC2 and PSU.
28	SCC2 watchdog error	Watchdog has been triggered.
29	SCC2 hardware error	SCC2 hardware error has been triggered.
32	Overcurrent PP1-3	Overcurrent on PP1/PP2/PP3.
33	DC undervoltage PP1	DC-voltage too low on PP1.
34	DC overvoltage PP1	DC-voltage too high on PP1.
35	Overcurrent PP4-6	Overcurrent on PP4/PP5/PP6.
36	DC undervoltage PP4	DC-voltage too low on PP4.
37	DC overvoltage PP4/midpoint	DC-voltage too high on PP4/midpoint.
38	Supervision watchdog error	System supervision function has failed.
64	AC voltage phase order incorrect	Phase order of the AC voltage connected to the SCC2 is incorrect.
65	AC undervoltage	AC voltage lower than 10% of nominal value.
66	AC overvoltage	AC voltage higher than 160% of nominal value.
67	DC precharge error	System failed to precharge. Check PPM.
68	Ambient overtemperature	Ambient temperature is above 55°C (50°C hysteresis)

69	PPM temperature difference	Temperature difference of 20°C between PPMs. Check cooling and fuses.
70	PPM overtemperature	Overtemperature in PPM. Check cooling.
71	External alarm	External alarm has been activated from Digital in or Modbus TCP.
72	Startup error	System failed to start. Check fuses and contactor.
73	Limitation error	System failed to limit its output current. Possible reasons include resonance.
74	AC phase loss	An AC phase has been lost. Check fuses.
Code	Warning	Cause/Action
101	PPM temperature high	PPM is at its temperature limit and is limiting its output current to stay below it.
102	Ambient temperature high	Ambient temperature is above 40°C (air-cooled system)
103	No master on multi-master bus	No master node found on multi-master bus, compensation has been disabled. Check the number of online nodes and if necessary disable the Node check setting in the Network settings.
104	Abnormal PP operation	Indicates a possible Power Module problem. Check fuses and IGBT.
105	Missing SD-card	No SD-card has been detected in the system, log file data will not be recorded. Check SD-card.
Code	State	
201	Stopped	System stopped (not running) and contactor open.
202	Pre-charging	System stopped (not running), contactor opened and pre-charging.
203	Operating	Normal operation (running).
204	Standby	System in standby mode (not running) and waiting for start condition.
205	Tripped	System has tripped on an alarm. (not running)

8 Power Indicator Button (PIB)

The PIB replaces the previously used auxiliary power switch in the door. It consists of a front panel mounted backlit button that makes it possible to completely turn on/off the system, start and stop operation and monitor its status.

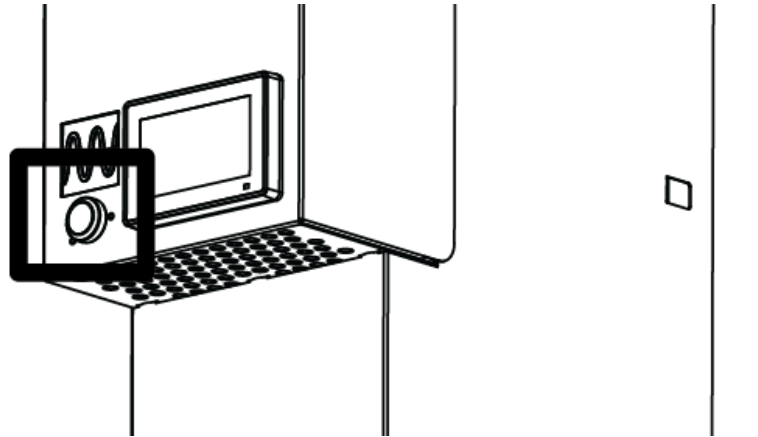

Figure 46: PIB location

To power the system on from a turned off state, press the PIB once (short press).

To power the system off, press and hold the PIB button for around 3 seconds, then release when the button has gone blank. The system is now powered off.

If turning the system off and on in quick succession, please allow 7 seconds to pass in between.

Table 22: Power Indicator Button modes

PIB LED color	Indication
Blank	The system is powered off. Press PIB once to power on the system.
Solid yellow	In standby waiting for start condition. Press PIB once to exit standby and enter pause mode.
Fading yellow	Please wait while pre-charging DC-link.
Solid green	In operation, press PIB once to end operation.
Fading green	In pause mode, press PIB once to begin operation.
Solid red	System has tripped. Press PIB once to acknowledge all alarms.
Fading red	System has tripped, writing log to SD-card in progress. Do not power off the system!
Solid orange	PIB malfunction, please verify that the system has a revision >1.9.0 software. If it has and it still does not work, contact Comsys.

9 Human Machine Interface 3 (HMI3)

The HMI3 consists of a 4.3" 480 x 272 color touchscreen display mounted on the front panel of the system. It allows simple configuration, diagnostics and monitoring all while standing in front of it.

9.1 HMI3 Overview

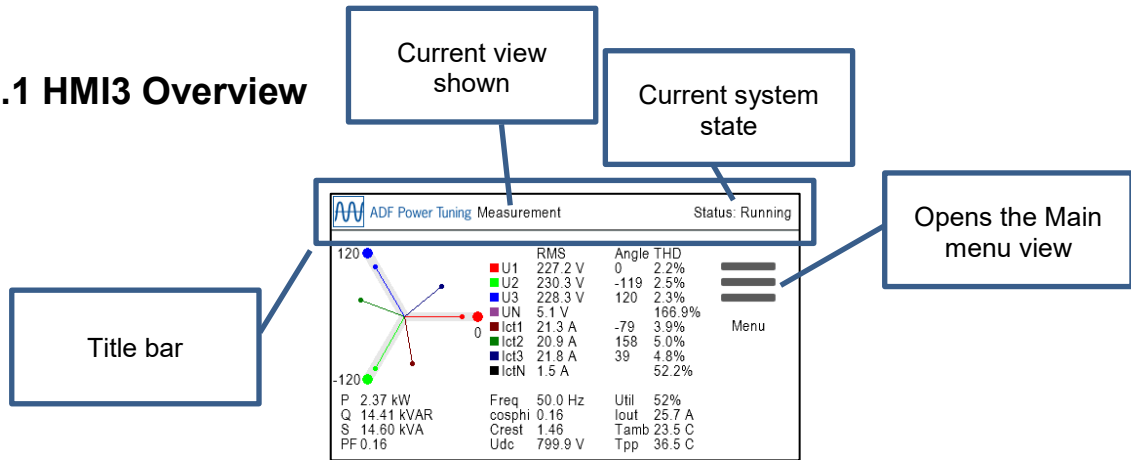

Figure 47: HMI3 main view

The top portion of the HMI3 screen consists of a title bar that always show the name of the current view and the current system state.

The menu structure is as follows:

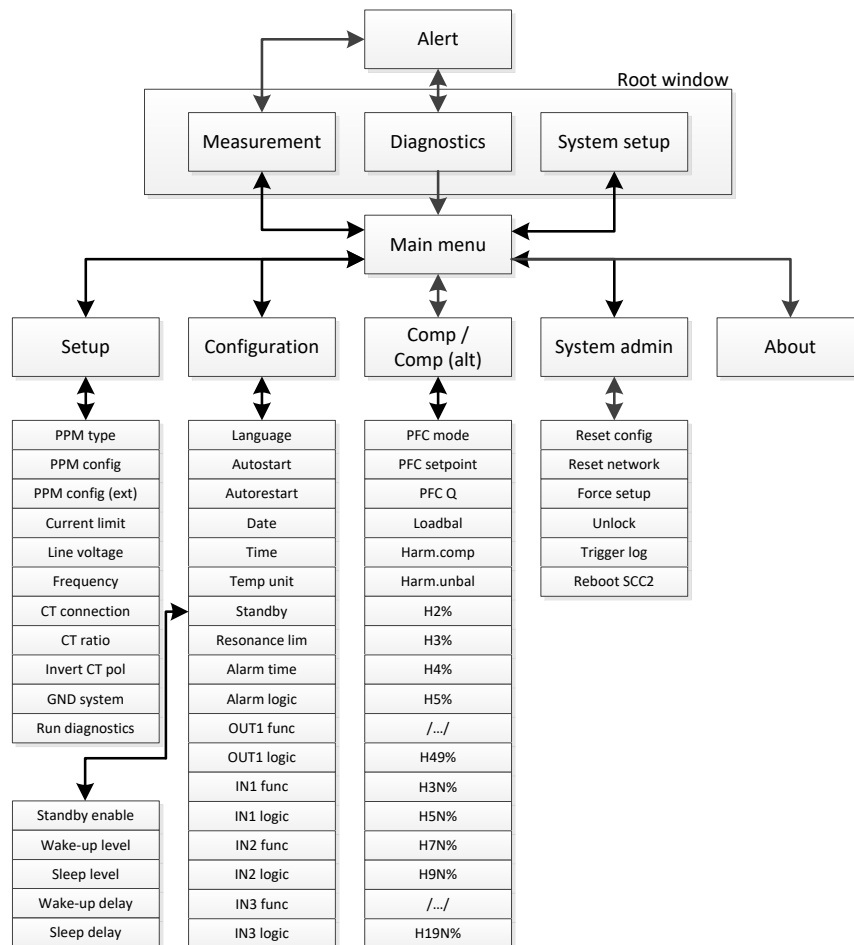

Figure 48: HMI3 menu overview

9.2 Root window

The root window can be either *System setup*, *Diagnostics* or *Measurement* depending on mode. All three views share the Menu icon and Alert icon.

The *Menu* icon leads to the *Main menu* view from which the menu structure can be accessed.

The *Alert* icon is visible when there are active alarms or warnings. Selecting it leads to the *Alert view* which will list them.

9.2.1 System setup

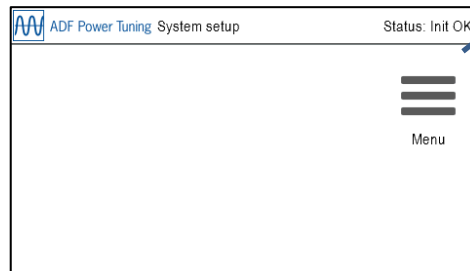

Opens the *Main menu* view

Figure 49: HMI3 System setup view

In *System setup* mode nothing except configuration can be performed. No control is running at this stage. Go in to *Menu*, then *Setup* and configure the system to continue. After changing the *Setup*, restart the system to enter *Diagnostics*.

9.2.2 Diagnostics

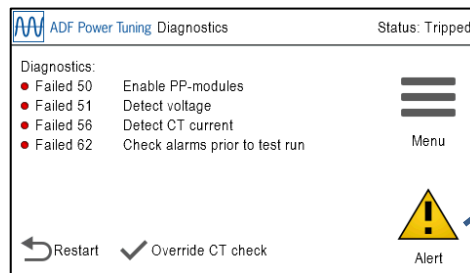

Opens the *Alert view*

Figure 50: HMI3 Diagnostics view

The *Diagnostics view* shows the outcome of the system diagnostics. If the CT current is low, the diagnostic checks involving CT current can be overridden by selecting *Override CT check*. To run the diagnostics again after mitigating the problem or choosing to override the CT check, select *Restart*. Please refer to Table 11 for more information on what the diagnostic codes mean.

9.2.3 Measurement

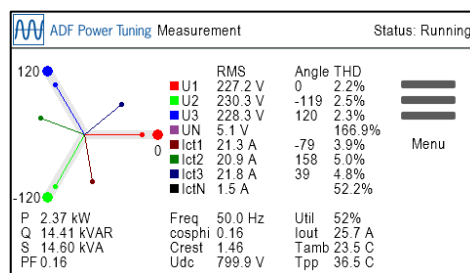

Figure 51: HMI3 Measurement view

The *Measurement view* shows power quality data which can be of interest when evaluating the performance of the system. This is the default view of the system.

The following parameters are shown:

Table 23: HMI3 Measurement table

Parameter	Description
U1, U2, U3 and UN	Phase voltages (RMS values in V, phase angles and THD)
I1, I2, I3 and IN	CT currents (RMS values in A, phase angles and THD)
P	Active power in kW
Q	Reactive power in kVAR
S	Apparent power in kVA
PF	Power factor
Iout	Output current
Util	System utilization shown in percent
Freq	Fundamental frequency in Hz
Tamb	Ambient air temperature in C° / F°
Tppm	Power module temperature in C° / F°
cosphi	Cos phi, displacement power factor
Crest	Crest factor of voltage
Udc	Power module DC-link voltage

9.3 Alert

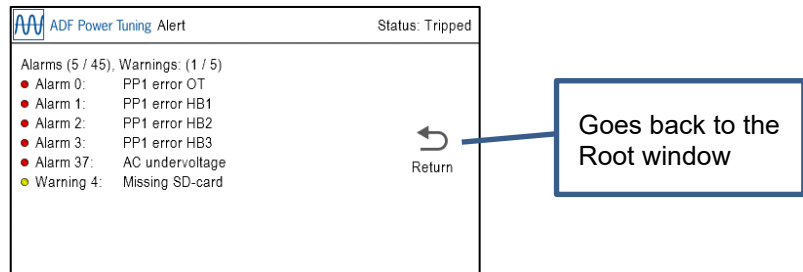

Figure 52: HMI3 Alert view

The *Alert* view shows the currently active *Warnings* and *Alarms*. Please refer to Table 21 for more information about alarms and warnings. Alarms can be acknowledged by pressing the PIB button when it is solid red.

9.4 Main menu

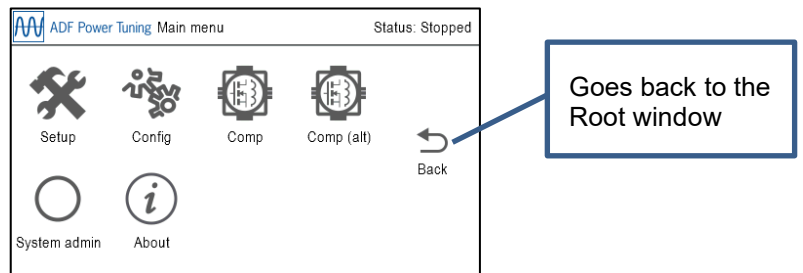

Figure 53: HMI3 Main menu view

From the Main menu the following submenus can be reached: *System Setup*, *Configuration*, *Compensation*, *System administration* and *About*.

9.5 Parameter Edit

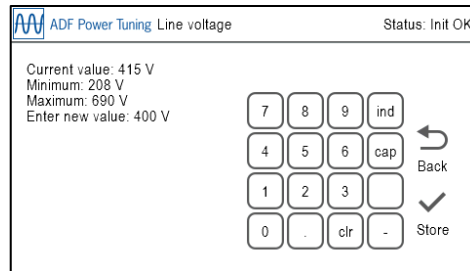

Figure 54: HMI3 Parameter Edit view

The *Parameter Edit* view allows a parameter to be edited using an on-screen keypad. When the entered value falls between the minimum and maximum values and is of correct format, the *Store* icon will appear. Selecting *Store* will save and apply the setting as well as return to the previous view.

To clear the entered input, press the *clr* button.

Some views allow input of decimal point (.), minus sign (-) and inductive / capacitive. These are always visible but only work in the views that require them.

If an administrator password has been set in the *Network window* in the WUI, the parameter is locked and cannot be changed. See Section 9.10 for information on how it can be unlocked.

9.6 Parameter Select

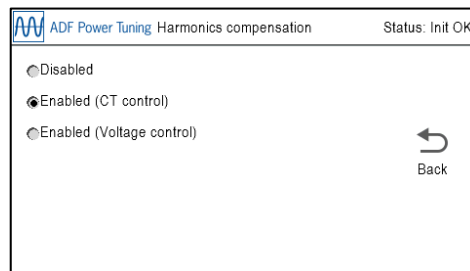

Figure 55: HMI3 Parameter Select view

The *Parameter Select* view allows a parameter to be edited by selecting one of several choices. Selecting a valid choice will save and apply the setting as well as return to the previous view.

If an administrator password has been set in the *Network window* in the WUI, the parameter is locked and cannot be changed. See Section 9.10 for information on how it can be unlocked.

9.7 Setup

Table 24: HMI3 Setup menu table

Parameter	Default	Description
PPM type	PPM300-3-A-100/480 (#0)	<p>Selects the PP-module type in the system</p> <p>Value: PPM300-3-A-100/480 (#0), PPM300-3-A-80/690 (#1), PPM300-3-W-140/690 (#2), PPM300-3-W-150/480 (#3), PPM300-3-A-100/480HC (#4), PPM300-4-A-100/480 (#5), ADF P100-100/480 (#6), ADF P100-70/480 (#7), Reserved (#8), PPM300-3-A-100/480HCB (#9), PPM300-3-W-150/480HCB (#10), PPM300v2-3-A-120/480 (#11), PPM300v2-3-A-90/690 (#12), PPM300v2-3-A-110/480-UL (#13), PPM300v2-3-A-90/600-UL (#14), ADF P100N-100/415 (#15), PPM300v2-3-A-130/480-OEM (#16), PPM300v2-3-A-90/690-OEM (#17), ADF P100v2-90/690 (#18), ADF P100v2-70/480 (#19), ADF P100v2-100/480 (#20), ADF P100v2-130/480 (#21), PPM300v2-3-W-150/480 (#22), PPM300v2-3-W-140/690 (#23), PPM300v2B-3-A-50/480 (#24), PPM300v2B-3-A-75/480 (#25), PPM300v2B-3-A-90/480 (#26), PPM300v2B-3-A-120/480 (#27), PPM300v2B-3-A-150/480 (#28), ADF P100v2B-50/480 (#29), ADF P100v2B-75/480 (#30), ADF P100v2B-90/480 (#31), ADF P100v2B-120/480 (#32), ADF P100v2B-150/480 (#33), PPM300v3-3-A-78/690 (#34), PPM300v3-3-A-130/480 (#35)</p> <p>This setting is locked if a Model key has been specified. For more information about the PP-module types, see the table in Section 4.3.1.</p>
PPM config	1 PPM installed	<p>Number of PP-modules connected to the primary PP-sockets at the base of the control computer.</p> <p>Value: No PPMs installed, 1 PPM installed, 2 PPMs installed, 3 PPMs installed</p>
PPM config (ext) **	No PPMs installed	<p>Number of PP-modules connected to the PP-sockets on the extender card **.</p> <p>Value: No PPMs installed, 1 PPM installed, 2 PPMs installed, 3 PPMs installed</p>
Current limit	100%	<p>Specifies a limitation factor in percent that is used for limiting the total output current of the system.</p> <p>Value: 0%...100%</p> <p>Can be set higher than 100% for certain PPM types if Overload mode is active. Please see Section 4.3.4 for more information.</p>
Line voltage	400 V	<p>Specifies nominal system voltage:</p> <p>480 V module: 208 V...480 V 600 V module: 480 V...600 V 690 V module: 480 V...690 V</p>
Frequency	50 Hz	<p>Specifies nominal system frequency</p> <p>Value: 50 Hz or 60 Hz</p>
CT connection	Closed loop CT	<p>External class 1.0 CT location:</p> <p>Open loop CT = open-loop (load side) Closed loop CT = closed-loop (grid side) No CT = No CT installed</p>
CT ratio	500 / 5	<p>CT primary transforming ratio (secondary fixed to 5 A):</p> <p>Value: 50 / 5 ... 50000 / 5</p>

Invert CT pol	Do not invert	Specifies if the polarity of the CT connection is inverted: Do not invert = Do nothing Invert = Invert the CT polarity
Grounding system	TN/TT	Specifies the grounding system according to IEC 60364: TN/TT = System has a direct connection to earth IT = System has no direct connection to earth
Run diagnostics	-	Save, restart the system and enter diagnostics

***) Available as an option

9.8 Configuration

Table 25: HMI3 Configuration menu table

Parameter	Default	Description
Language	English	Selects the language for ADF Dashboard (Note: not HMI3). Restart is required before the setting takes effect. Value: English, Swedish, German or Chinese
Autostart	Disabled	Enable/Disable the autostart function: Disabled = Autostart disabled Instant = Autostart enabled with instant start 10 seconds, 20 seconds, ..., 60 seconds = Autostart enabled with startup delay
Autorestart	Disabled	Controls the autorestart function. Allows for a maximum of 10 restart attempts in an hour. Disabled = Autorestart after alarm is disabled Enabled = Autorestart after alarm is enabled
Date	20000101	Sets the system date with YYYY as four-digit year, MM as month, and DD as day: YYYYMMDD
Time	000000	Sets the system time with HH as hour (24 hours), mm as minutes and ss as seconds: HHmmss
Temp unit	Celsius	Selects default temperature unit: Value: Fahrenheit or Celsius
Standby – Standby enable	Disabled	Controls the standby function: Disabled = Standby function is disabled Enabled = System will automatically start and stop depending on the load.
Standby – Wake-up level	20%	Controls the threshold over which the system will wake-up when in standby mode. This is defined as a percentage of the maximum rated CT current seen on the load current in fundamental frequency. Example: If the CT is 500/5 and the setting 20%, the filter will start when the load current in fundamental frequency is greater than $500 * 0.2 = 100$ A. Can be set between 0% and 100%.
Standby – Sleep level	85%	Controls the threshold under which the system will go to sleep when the standby function is enabled. This is defined as a percentage of the Standby wake-up threshold setting. Given a 500/5 CT ratio, a start threshold of 20% and a stop threshold of 85%, the filter will go in to standby mode when the load current in fundamental frequency goes below $500 * 0.2 * 0.85 = 85$ A. Can be set between 0% and 95%.
Standby – Wake-up delay	0 s	Sets for how long the wake-up threshold must be exceeded before the system is started when in standby mode. Can be set between 0 s and 300 s.
Standby – Sleep delay	60 s	Sets for how long the sleep threshold must be stayed under before the system is stopped and put in standby mode. Can be set between 5s and 300 s.
Resonance lim	20%	The resonance limit setting sets the limit in voltage amplitude for each harmonic. When exceeded, the harmonic in question will be blocked for one hour. After one hour, the harmonic will again be activated. This is defined as a percentage of the voltage amplitude in the fundamental frequency. Can be set between 1% and 100% .
Alarm time	10 s	Sets Alarm relay minimum activation time Values: 1 ... 255 seconds
Alarm logic	Normally closed	Select Alarm relay logic * Values: Normally open, Normally Closed

OUT1 function	Off	Select output OUT1 relay activation function. Available choices: None selected = OUT1 disabled One or several selected = OUT1 activates when any one of the selected conditions are active. A full list of the available choices for the activation function can be found in Table 21.
OUT1 logic	Normally open	Select output OUT1 relay logic * Values: Normally open, Normally Closed
IN1 func	Off	Selects digital IN1 function: Off = Disabled, Trigger alarm = Trigger external alarm, Start system = Start the system, Stop system = Stop the system, Acknowledge alarm = Acknowledge all alarms, Use secondary compensation set = Use secondary set of compensation settings, Start/stop system = Start/stop the system. See section 5.1.14 for more information.
IN1 logic	Active low	Select input IN1 logic: Values: Active low, Active high
IN2 func	Off	Selects digital IN2 function: Off = Disabled, Trigger alarm = Trigger external alarm, Start system = Start the system, Stop system = Stop the system, Acknowledge alarm = Acknowledge all alarms, Use secondary compensation set = Use secondary set of compensation settings, Start/stop system = Start/stop the system. See section 5.1.14 for more information.
IN2 logic	Active low	Select input IN2 logic: Values: Active low, Active high
IN3 func	Off	Selects digital IN3 function: Off = Disabled, Trigger alarm = Trigger external alarm, Start system = Start the system, Stop system = Stop the system, Acknowledge alarm = Acknowledge all alarms, Use secondary compensation set = Use secondary set of compensation settings, Start/stop system = Start/stop the system. See section 5.1.14 for more information.
IN3 logic	Active low	Select input IN3 logic: Values: Active low, Active high

* All relays are physically normally-open when the system is turned off.

9.9 Compensation / Compensation (alt)

Table 26: HMI3 Compensation menu table

Parameter	Default	Description
PFC mode	Disabled	Selects Power Factor Correction mode: Value: Disabled, Dynamic = Dynamic compensation based on PFC setpoint, Dynamic (inductive) = Dynamic compensation in inductive direction only, Dynamic (capacitive) = Dynamic compensation in capacitive direction only. Static = Static output of reactive power (PFC Q)
PFC setpoint	0.97 (ind)	Setpoint for Power factor in Dynamic PFC mode: Value: 0.5 inductive to 0.5 capacitive , step 0.01.
PFC Q	0	Fixed reactive power in Static PFC mode. Value: MAX inductive ... 0 ... MAX capacitive* (rating of system), step 1 kVAR
Loadbal	Disabled	Selects load balancing mode: Value: Disabled, Enabled (Line to Line), Enabled (Line to Neutral) **, Enabled (Line to Line and Line to Neutral) **
Harm.comp	Disabled	Enables or disables harmonic compensation globally Value: Disabled, Enabled (CT control), Enabled (Sensorless Control) ****
Harm.unbal	Disabled	Enables or disables support for unbalanced harmonics: Value: Disabled, Enabled
H2% ***	0	Degree of compensation: 0%...100%
H3%	0	Degree of compensation: 0%...100%
H4% ***	0	Degree of compensation: 0%...100%
H5%	0	Degree of compensation: 0%...100%
H6% ***	0	Degree of compensation: 0%...100%
H7%	0	Degree of compensation: 0%...100%
H8% ***	0	Degree of compensation: 0%...100%
H9%	0	Degree of compensation: 0%...100%
H11%	0	Degree of compensation: 0%...100%
H13%	0	Degree of compensation: 0%...100%
H15%	0	Degree of compensation: 0%...100%

H17%	0	Degree of compensation: 0%...100%
H19%	0	Degree of compensation: 0%...100%
H21%	0	Degree of compensation: 0%...100%
H23%	0	Degree of compensation: 0%...100%
H25%	0	Degree of compensation: 0%...100%
H29%	0	Degree of compensation: 0%...100%
H31%	0	Degree of compensation: 0%...100%
H35%	0	Degree of compensation: 0%...100%
H37%	0	Degree of compensation: 0%...100%
H41%	0	Degree of compensation: 0%...100%
H43%	0	Degree of compensation: 0%...100%
H47%	0	Degree of compensation: 0%...100%
H49%	0	Degree of compensation: 0%...100%
H3N% **	0	Degree of compensation: 0%...100%
H5N% **	0	Degree of compensation: 0%...100%
H7N% **	0	Degree of compensation: 0%...100%
H9N% **	0	Degree of compensation: 0%...100%
H11N% **	0	Degree of compensation: 0%...100%
H13N% **	0	Degree of compensation: 0%...100%
H15N% **	0	Degree of compensation: 0%...100%
H17N% **	0	Degree of compensation: 0%...100%
H19N% **	0	Degree of compensation: 0%...100%

*) The kVA rating of the system is stated in the technical specification. **) Available in 4-wire systems only. ***) Even harmonics available as an option. ****) Sensorless Control is available as an option, contact Comsys.

9.10 System admin

Table 27: HMI3 System admin menu table

Parameter	Description
Reset config	Resets all configuration settings and compensation settings to default values.
Reset network	Resets all network settings to default values. A system restart is necessary for the changes to take effect.
Force setup	Will force the system to enter <i>System setup mode</i> after restart.
Unlock	Unlocks the HMI when an administrator password is set. The unlock code is 61874 .
Trigger log	Triggers the creation of a log file. Only do this when instructed to do so by Comsys.
Reboot SCC2	Restarts the SCC2 control computer.

9.11 About

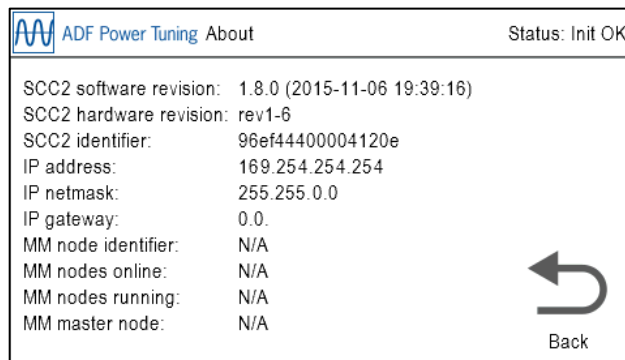

Figure 56: HMI3 About view

The *About* view shows useful information about the system, such as software build revision and build date/time, SCC2 hardware revision and unique identifier, IP settings and multi-master configuration/status.

Appendix A Modbus TCP server

This section outlines the Modbus TCP server implementation.

NOTE Modbus TCP server support is a license key activated option. If you wish to use this feature, please contact Comsys.

The Modbus TCP server can be reached via TCP as well as UDP on port 502 of the IP-address configured in Section 0.

All registers described below are so called holding registers. The following two function codes (Fc) are supported for manipulating and reading out the registers:

- Fc 3: Read multiple registers
- Fc 16: Write multiple registers

The registers are divided in to groups by their function. It's recommended that operations are performed on an entire group at once. For example, reading out the status registers can be done in one operation of *Fc 3: Read multiple registers*, the same way that the control registers can be set in one operation of *Fc 16: Write multiple registers*.

The register map starts at address 0 and each word is 16-bits long. For variables larger than 16-bits, little-endian word order is used. This means that the word containing the most significant bit comes before the word containing the least significant bit.

NOTE Some Modbus TCP implementations use address 1 as the very first address in the address range. In those cases, address 1 is equivalent to address 0 in this document, address 2 is equivalent to address 1 in this document and so forth.

A.1 Status registers

This group of registers gives an overview of the system status. This includes the system state and measurement values such as voltages, currents and temperatures.

Address	Register name	Data type	Description
0000	s_state	16-bit integer	Control computer state: 0 = Init OK 1 = Pre-charge start 2 = Pre-chaging 3 = Engaging contactor 4 = Starting 5 = Starting 6 = Starting 7 = Starting 8 = Starting 9 = Starting 10 = ADF operating 11 = ADF stopping 12 = ADF stopped (ready for start) 13 = Low voltage test mode 14 = ADF standby 20 = Starting 21 = Starting 22 = Waiting for autostart timer 23 = Starting 1000 = System tripped on alarm
0001 = High data 0002 = Low data	s_ol_d_alarm_mask	32-bit integer	Obsolete alarm mask. Replaced with address 0070 to 0075 below.
0003 = High data 0004 = Low data	s_ol_d_warn_mask	32-bit integer	Obsolete warning mask. Replaced with address 0076 to 0077 below.

0005	s_di_mask	16-bit integer	Digital in bit mask: Bit 0 = Digital In #1 Bit 1 = Digital In #2 Bit 2 = Digital In #3 Bit 3 = Digital In #4 Bit 4 = Contactor closed Bit 5-15 = Reserved
0006	s_do_mask	16-bit integer	Digital out bit mask: Bit 0 = Digital out #1 Bit 1 = Digital out #2 Bit 2 = Digital out #3 Bit 3 = Digital out alarm Bit 4-15 = Reserved
0007	s_tpp1	16-bit integer	Temperature of PPM #1 (deg C)
0008	s_tpp2	16-bit integer	Temperature of PPM #2 (deg C)
0009	s_tpp3	16-bit integer	Temperature of PPM #3 (deg C)
0010	s_tpp4	16-bit integer	Temperature of PPM #4 (deg C)
0011	s_tpp5	16-bit integer	Temperature of PPM #5 (deg C)
0012	s_tpp6	16-bit integer	Temperature of PPM #6 (deg C)
0013	s_tamb	16-bit integer	Ambient temperature (deg C)
0014	s_twint	16-bit integer	Internal water temperature (deg C)
0015	s_twext	16-bit integer	External water temperature (deg C)
0016	s_taux1	16-bit integer	Auxiliary temperature #1 (deg C)
0017	s_taux2	16-bit integer	Auxiliary temperature #2 (deg C)
0018	s_taux3	16-bit integer	Auxiliary temperature #3 (deg C)
0019	s_utilization	16-bit integer	System utilization in percent of maximum output current (%)
0020 = High data 0021 = Low data	s_iout_rms_avg	32-bit floating-point	ADF output current average (A_{RMS})
0022 = High data 0023 = Low data	s_iout_rms_a	32-bit floating-point	ADF output current phase A (A_{RMS})
0024 = High data 0025 = Low data	s_iout_rms_b	32-bit floating-point	ADF output current phase B (A_{RMS})
0026 = High data 0027 = Low data	s_iout_rms_c	32-bit floating-point	ADF output current phase C (A_{RMS})
0028 = High data 0029 = Low data	s_ict_rms_avg	32-bit floating-point	CT current average (A_{RMS})
0030 = High data 0031 = Low data	s_ict_rms_a	32-bit floating-point	CT current phase A (A_{RMS})
0032 = High data 0033 = Low data	s_ict_rms_b	32-bit floating-point	CT current phase B (A_{RMS})
0034 = High data 0035 = Low data	s_ict_rms_c	32-bit floating-point	CT current phase C (A_{RMS})
0036 = High data 0037 = Low data	s_voltage_rms_avg	32-bit floating-point	Phase voltage average (V_{RMS})
0038 = High data 0039 = Low data	s_voltage_rms_a	32-bit floating-point	Phase voltage phase A (V_{RMS})
0040 = High data 0041 = Low data	s_voltage_rms_b	32-bit floating-point	Phase voltage phase B (V_{RMS})
0042 = High data 0043 = Low data	s_voltage_rms_c	32-bit floating-point	Phase voltage phase C (V_{RMS})
0044 = High data 0045 = Low data	s_frequency	32-bit floating-point	Line frequency (Hz)
0046 = High data 0047 = Low data	s_pnet	32-bit floating-point	Active power (W)
0048 = High data 0049 = Low data	s_qnet	32-bit floating-point	Reactive power (VAR)
0050 = High data 0051 = Low data	s_snet	32-bit floating-point	Apparent power (VA)
0052	s_mm_node_id	16-bit integer	The system's own node identifier/address on the multi-master bus.

0053	s_mm_num_nodes_on_bus	16-bit integer	The number of online nodes on the multi-master bus. A value of 0 indicates that the multi-master feature is disabled.
0054	s_mm_num_nodes_running	16-bit integer	The number of running nodes on the multi-master bus.
0055	s_parallel_master_node	16-bit integer	The node identifier of the current master node. A value of 15 indicates that there is no master on the bus.
0056 = High data 0057 = Low data	s_iout_rms_n	32-bit floating-point	ADF output current neutral (A_{RMS})
0058 = High data 0059 = Low data	s_ict_rms_n	32-bit floating-point	CT current neutral (A_{RMS})
0060 = High data 0061 = Low data	s_voltage_rms_n	32-bit floating-point	Phase voltage neutral (V_{RMS})
0062 = High data 0063 = Low data	s_thdu_avg	32-bit floating-point	THD of phase voltage average (%)
0064 = High data 0065 = Low data	s_thdi_avg	32-bit floating-point	THD of CT current average (%)
0066 = High data 0067 = Low data	s_pf	32-bit floating-point	Power factor
0068 = High data 0069 = Low data	s_cosphi	32-bit floating-point	Cos phi
0070 = High data 0071 = Low data	s_alarm_mask_1	32-bit integer	Alarm bit mask #1: Bit 0 = PP1 error OT Bit 1 = PP1 error HB1 Bit 2 = PP1 error HB2 Bit 3 = PP1 error HB3 Bit 4 = PP2 error OT Bit 5 = PP2 error HB1 Bit 6 = PP2 error HB2 Bit 7 = PP2 error HB3 Bit 8 = PP3 error OT Bit 9 = PP3 error HB1 Bit 10 = PP3 error HB2 Bit 11 = PP3 error HB3 Bit 12 = PP4 error OT Bit 13 = PP4 error HB1 Bit 14 = PP4 error HB2 Bit 15 = PP4 error HB3 Bit 16 = PP5 error OT Bit 17 = PP5 error HB1 Bit 18 = PP5 error HB2 Bit 19 = PP5 error HB3 Bit 20 = PP6 error OT Bit 21 = PP6 error HB1 Bit 22 = PP6 error HB2 Bit 23 = PP6 error HB3 Bit 24 = SCC2 supply error #1 Bit 25 = SCC2 supply error #2 Bit 26 = SCC2 supply error #3 Bit 27 = SCC2 watchdog error Bit 28 = SCC2 hardware error
0072 = High data 0073 = Low data	s_alarm_mask_2	32-bit integer	Alarm bit mask #2: Bit 0 = Overcurrent PP1-3 Bit 1 = DC undervoltage PP1 Bit 2 = DC overvoltage PP1 Bit 3 = Overcurrent PP4-6 Bit 4 = DC undervoltage PP4 Bit 5 = DC overvoltage PP4/midpoint Bit 6 = Supervision watchdog error
0074 = High data 0075 = Low data	s_alarm_mask_3	32-bit integer	Alarm bit mask #3: Bit 0 = AC voltage phase order incorrect Bit 1 = AC undervoltage Bit 2 = AC overvoltage Bit 3 = DC precharge error Bit 4 = Ambient overtemperature Bit 5 = PPM temperature difference Bit 6 = PPM overtemperature Bit 7 = External alarm Bit 8 = Startup error Bit 9 = Limitation error Bit 10 = AC phase loss

0076 = High data 0077 = Low data	s_warn_mask	32-bit integer	Warning bit mask: Bit 0 = PPM temperature high Bit 1 = Ambient temperature high Bit 2 = No master on multi-master bus Bit 3 = Abnormal PP operation Bit 4 = Missing SD-card
-------------------------------------	-------------	----------------	---

A.2 Control registers

This group of registers allows the manipulation of the system state similar to what can be done using the Digital inputs.



ATTENTION: Do not mix digital input and Modbus TCP control commands to the same function. Doing this will lead to unpredictable behavior.

For example, do not start and stop the system using both digital input and Modbus TCP.

Address	Register name	Data type	Description
0200	c_start	16-bit integer	0 = Do nothing 1 = Start the system
0201	c_stop	16-bit integer	0 = Do nothing 1 = Stop the system
0202	c_trig_extalarm	16-bit integer	0 = Do nothing 1 = Trigger external alarm
0203	c_ack_extalarm	16-bit integer	0 = Do nothing 1 = Acknowledge external alarm
0204	c_secondary_comp_set	16-bit integer	0 = Use primary compensation set 1 = Use secondary compensation set
0205	c_sp_mode	16-bit integer	0 = Setpoints via Modbus are not used 1 = PFC is overridden by <i>c_sp_ifund_reactive</i>
0206	c_sp_ifund_reactive	16-bit integer	Reactive current to be outputted by the ADF. The unit is whole amperes per PPM. Value: -MAX* (inductive) ... 0 ... MAX* (capacitive) * MAX is the rated maximum output current per power module in the system. Example: To output 225 A on a system with 3 power modules, this variable should be set to 75.

A.3 Compensation settings

This group of registers allows reading out and manipulation of the primary and secondary compensation setting groups.

It is important that the minimum, maximum and step attributes of each register is respected. Attempting to write an illegal value to any register below will yield error code 4 (*FAILURE*) and the entire operation will be aborted.

During multi-master parallel operation, these settings can only be changed on the master node; attempting to change the settings on the slave will yield error code 4 (*FAILURE*).

The compensation settings will be automatically synchronized with the slave nodes via the multi-master bus. When this synchronization is in progress, attempting to write to these registers will yield error code 6 (*BUSY*). It is therefore recommended to check the return status when writing to the registers.

To store the updated settings to flash, the last register *write_flash* should be set to 1. When updating the settings often, please avoid writing them to flash as the flash memory has a finite number of write cycles.



ATTENTION: The flash memory can handle a minimum of 400,000 write cycles. Exceeding this number can destroy the flash memory.

A.3.1 Primary compensation setting registers

Address	Register name	Data type	Description
0400	cp_pfc_mode	16-bit integer	Selects Power Factor Correction mode: 0 = Disabled 1 = Dynamic compensation according to cp_pfc_setp. 2 = Static output of reactive power according to cp_pfc_stat_q 3 = Dynamic compensation according to cp_pfc_setp. Work in inductive direction only. 4 = Dynamic compensation according to cp_pfc_setp. Work in capacitive direction only.
0401	cp_pfc_dyn_setp	16-bit integer	Setpoint for Power factor in PFC dynamic mode: Value: -50 ... 0 ... 50 . -50 to -1 = PF 0.(100+value) inductive 0 = PF 1.00 1 to 50 = PF 0.(100-value) capacitive Example: A value of -3 would translate to a power factor of 0.(100-3) = 0.97 inductive
0402	cp_pfc_stat_q	16-bit integer	Fixed reactive power in PFC static mode: Value: -MAX inductive ... 0 ... MAX capacitive* (rating of system), step 1 kVAR
0403	cp_load_bal_en	16-bit integer	Selects load balancing mode: 0 = Disabled 1 = Line to Line 2 = Line to Neutral 3 = Line to Line & Line to Neutral
0404	cp_harm_comp_en	16-bit integer	Enables or disables harmonic compensation: 0 = Disabled 1 = Enabled (CT control) 2 = Enabled (Sensorless Control)
0405	cp_harm_unbal_en	16-bit integer	Enables or disables support for unbalanced harmonics. 0 = Disabled 1 = Enabled
0406	cp_harm_h2	16-bit integer	Degree of compensation for the 2 nd harmonic: 0% ... 100%
0407	cp_harm_h3	16-bit integer	Degree of compensation for the 3 rd harmonic: 0% ... 100%

0408	cp_harm_h4	16-bit integer	Degree of compensation for the 4 th harmonic: 0% ... 100%
0409	cp_harm_h5	16-bit integer	Degree of compensation for the 5 th harmonic: 0% ... 100%
0410	cp_harm_h6	16-bit integer	Degree of compensation for the 6 th harmonic: 0% ... 100%
0411	cp_harm_h7	16-bit integer	Degree of compensation for the 7 th harmonic: 0% ... 100%
0412	cp_harm_h8	16-bit integer	Degree of compensation for the 8 th harmonic: 0% ... 100%
0413	cp_harm_h9	16-bit integer	Degree of compensation for the 9 th harmonic: 0% ... 100%
0414	cp_harm_h11	16-bit integer	Degree of compensation for the 11 th harmonic: 0% ... 100%
0415	cp_harm_h13	16-bit integer	Degree of compensation for the 13 th harmonic: 0% ... 100%
0416	cp_harm_h15	16-bit integer	Degree of compensation for the 15 th harmonic: 0% ... 100%
0417	cp_harm_h17	16-bit integer	Degree of compensation for the 17 th harmonic: 0% ... 100%
0418	cp_harm_h19	16-bit integer	Degree of compensation for the 19 th harmonic: 0% ... 100%
0419	cp_harm_h21	16-bit integer	Degree of compensation for the 21 st harmonic: 0% ... 100%
0420	cp_harm_h23	16-bit integer	Degree of compensation for the 23 rd harmonic: 0% ... 100%
0421	cp_harm_h25	16-bit integer	Degree of compensation for the 25 th harmonic: 0% ... 100%
0422	cp_harm_h29	16-bit integer	Degree of compensation for the 29 th harmonic: 0% ... 100%
0423	cp_harm_h31	16-bit integer	Degree of compensation for the 31 st harmonic: 0% ... 100%
0424	cp_harm_h35	16-bit integer	Degree of compensation for the 35 th harmonic: 0% ... 100%
0425	cp_harm_h37	16-bit integer	Degree of compensation for the 37 th harmonic: 0% ... 100%
0426	cp_harm_h41	16-bit integer	Degree of compensation for the 41 st harmonic: 0% ... 100%
0427	cp_harm_h43	16-bit integer	Degree of compensation for the 43 rd harmonic: 0% ... 100%
0428	cp_harm_h47	16-bit integer	Degree of compensation for the 47 th harmonic: 0% ... 100%
0429	cp_harm_h49	16-bit integer	Degree of compensation for the 49 th harmonic: 0% ... 100%
0430	cp_harm_h3n	16-bit integer	Degree of compensation for the 3 rd zero-sequence harmonic: 0% ... 100%
0431	cp_harm_h5n	16-bit integer	Degree of compensation for the 5 th zero-sequence harmonic: 0% ... 100%
0432	cp_harm_h7n	16-bit integer	Degree of compensation for the 7 th zero-sequence harmonic: 0% ... 100%
0433	cp_harm_h9n	16-bit integer	Degree of compensation for the 9 th zero-sequence harmonic: 0% ... 100%
0434	cp_harm_h11n	16-bit integer	Degree of compensation for the 11 th zero-sequence harmonic: 0% ... 100%
0435	cp_harm_h13n	16-bit integer	Degree of compensation for the 13 th zero-sequence harmonic: 0% ... 100%
0436	cp_harm_h15n	16-bit integer	Degree of compensation for the 15 th zero-sequence harmonic: 0% ... 100%
0437	cp_harm_h17n	16-bit integer	Degree of compensation for the 17 th zero-sequence harmonic: 0% ... 100%
0438	cp_harm_h19n	16-bit integer	Degree of compensation for the 19 th zero-sequence harmonic: 0% ... 100%
0439	cp_harm_h2_angle	16-bit integer	Angle calibration for the 2 nd harmonic in open-loop. 0 deg ... 359 deg
0440	cp_harm_h3_angle	16-bit integer	Angle calibration for the 3 rd harmonic in open-loop. 0 deg ... 359 deg

0441	cp_harm_h4_angle	16-bit integer	Angle calibration for the 4 th harmonic in open-loop. 0 deg ... 359 deg
0442	cp_harm_h5_angle	16-bit integer	Angle calibration for the 5 th harmonic in open-loop. 0 deg ... 359 deg
0443	cp_harm_h6_angle	16-bit integer	Angle calibration for the 6 th harmonic in open-loop. 0 deg ... 359 deg
0444	cp_harm_h7_angle	16-bit integer	Angle calibration for the 7 th harmonic in open-loop. 0 deg ... 359 deg
0445	cp_harm_h8_angle	16-bit integer	Angle calibration for the 8 th harmonic in open-loop. 0 deg ... 359 deg
0446	cp_harm_h9_angle	16-bit integer	Angle calibration for the 9 th harmonic in open-loop. 0 deg ... 359 deg
0447	cp_harm_h11_angle	16-bit integer	Angle calibration for the 11 th harmonic in open-loop. 0 deg ... 359 deg
0448	cp_harm_h13_angle	16-bit integer	Angle calibration for the 13 th harmonic in open-loop. 0 deg ... 359 deg
0449	cp_harm_h15_angle	16-bit integer	Angle calibration for the 15 th harmonic in open-loop. 0 deg ... 359 deg
0450	cp_harm_h17_angle	16-bit integer	Angle calibration for the 17 th harmonic in open-loop. 0 deg ... 359 deg
0451	cp_harm_h19_angle	16-bit integer	Angle calibration for the 19 th harmonic in open-loop. 0 deg ... 359 deg
0452	cp_harm_h21_angle	16-bit integer	Angle calibration for the 21 st harmonic in open-loop. 0 deg ... 359 deg
0453	cp_harm_h23_angle	16-bit integer	Angle calibration for the 23 rd harmonic in open-loop. 0 deg ... 359 deg
0454	cp_harm_h25_angle	16-bit integer	Angle calibration for the 25 th harmonic in open-loop. 0 deg ... 359 deg
0455	cp_harm_h29_angle	16-bit integer	Angle calibration for the 29 th harmonic in open-loop. 0 deg ... 359 deg
0456	cp_harm_h31_angle	16-bit integer	Angle calibration for the 31 st harmonic in open-loop. 0 deg ... 359 deg
0457	cp_harm_h35_angle	16-bit integer	Angle calibration for the 35 th harmonic in open-loop. 0 deg ... 359 deg
0458	cp_harm_h37_angle	16-bit integer	Angle calibration for the 37 th harmonic in open-loop. 0 deg ... 359 deg
0459	cp_harm_h41_angle	16-bit integer	Angle calibration for the 41 st harmonic in open-loop. 0 deg ... 359 deg
0460	cp_harm_h43_angle	16-bit integer	Angle calibration for the 43 rd harmonic in open-loop. 0 deg ... 359 deg
0461	cp_harm_h47_angle	16-bit integer	Angle calibration for the 47 th harmonic in open-loop. 0 deg ... 359 deg
0462	cp_harm_h49_angle	16-bit integer	Angle calibration for the 49 th harmonic in open-loop. 0 deg ... 359 deg
0463	cp_write_flash	16-bit integer	Write all parameters to flash. Setting this register to 1 will store the complete parameter set, including both primary and secondary compensation set, to flash.

A.3.2 Secondary compensation setting registers

Address	Register name	Data type	
0600	cs_pfc_mode	16-bit integer	Selects Power Factor Correction mode: 0 = Disabled 1 = Dynamic compensation according to cs_pfc_setp. 2 = Static output of reactive power according to cs_pfc_stat_q 3 = Dynamic compensation according to cs_pfc_setp. Work in inductive direction only. 4 = Dynamic compensation according to cs_pfc_setp. Work in capacitive direction only.

0601	cs_pfc_setp	16-bit integer	Setpoint for Power factor in PFC dynamic mode: Value: -50 ... 0 ... 50 . -50 to -1 = PF 0.(100+value) inductive 0 = PF 1.00 1 to 50 = PF 0.(100-value) capacitive Example: A value of -3 would translate to a power factor of 0.(100-3) = 0.97 inductive
0602	cs_pfc_stat_q	16-bit integer	Fixed reactive power in PFC static mode: Value: -MAX inductive ... 0 ... MAX capacitive* (rating of system), step 1 kVAR
0603	cs_load_bal_en	16-bit integer	Selects load balancing mode: 0 = Disabled 1 = Line to Line 2 = Line to Neutral 3 = Line to Line & Line to Neutral
0604	cs_harm_comp_en	16-bit integer	Enables or disables harmonic compensation: 0 = Disabled 1 = Enabled (CT control) 2 = Enabled (Sensorless Control)
0605	cs_harm_unbal_en	16-bit integer	Enables or disables support for unbalanced harmonics. 0 = Disabled 1 = Enabled
0606	cs_harm_h2	16-bit integer	Degree of compensation for the 2 nd harmonic: 0% ... 100%
0607	cs_harm_h3	16-bit integer	Degree of compensation for the 3 rd harmonic: 0% ... 100%
0608	cs_harm_h4	16-bit integer	Degree of compensation for the 4 th harmonic: 0% ... 100%
0609	cs_harm_h5	16-bit integer	Degree of compensation for the 5 th harmonic: 0% ... 100%
0610	cs_harm_h6	16-bit integer	Degree of compensation for the 6 th harmonic: 0% ... 100%
0611	cs_harm_h7	16-bit integer	Degree of compensation for the 7 th harmonic: 0% ... 100%
0612	cs_harm_h8	16-bit integer	Degree of compensation for the 8 th harmonic: 0% ... 100%
0613	cs_harm_h9	16-bit integer	Degree of compensation for the 9 th harmonic: 0% ... 100%
0614	cs_harm_h11	16-bit integer	Degree of compensation for the 11 th harmonic: 0% ... 100%
0615	cs_harm_h13	16-bit integer	Degree of compensation for the 13 th harmonic: 0% ... 100%
0616	cs_harm_h15	16-bit integer	Degree of compensation for the 15 th harmonic: 0% ... 100%
0617	cs_harm_h17	16-bit integer	Degree of compensation for the 17 th harmonic: 0% ... 100%
0618	cs_harm_h19	16-bit integer	Degree of compensation for the 19 th harmonic: 0% ... 100%
0619	cs_harm_h21	16-bit integer	Degree of compensation for the 21 st harmonic: 0% ... 100%
0620	cs_harm_h23	16-bit integer	Degree of compensation for the 23 rd harmonic: 0% ... 100%
0621	cs_harm_h25	16-bit integer	Degree of compensation for the 25 th harmonic: 0% ... 100%
0622	cs_harm_h29	16-bit integer	Degree of compensation for the 29 th harmonic: 0% ... 100%
0623	cs_harm_h31	16-bit integer	Degree of compensation for the 31 st harmonic: 0% ... 100%
0624	cs_harm_h35	16-bit integer	Degree of compensation for the 35 th harmonic: 0% ... 100%
0625	cs_harm_h37	16-bit integer	Degree of compensation for the 37 th harmonic: 0% ... 100%
0626	cs_harm_h41	16-bit integer	Degree of compensation for the 41 st harmonic: 0% ... 100%

0627	cs_harm_h43	16-bit integer	Degree of compensation for the 43 rd harmonic: 0% ... 100%
0628	cs_harm_h47	16-bit integer	Degree of compensation for the 47 th harmonic: 0% ... 100%
0629	cs_harm_h49	16-bit integer	Degree of compensation for the 49 th harmonic: 0% ... 100%
0630	cs_harm_h3n	16-bit integer	Degree of compensation for the 3 rd zero-sequence harmonic: 0% ... 100%
0631	cs_harm_h5n	16-bit integer	Degree of compensation for the 5 th zero-sequence harmonic: 0% ... 100%
0632	cs_harm_h7n	16-bit integer	Degree of compensation for the 7 th zero-sequence harmonic: 0% ... 100%
0633	cs_harm_h9n	16-bit integer	Degree of compensation for the 9 th zero-sequence harmonic: 0% ... 100%
0634	cs_harm_h11n	16-bit integer	Degree of compensation for the 11 th zero-sequence harmonic: 0% ... 100%
0635	cs_harm_h13n	16-bit integer	Degree of compensation for the 13 th zero-sequence harmonic: 0% ... 100%
0636	cs_harm_h15n	16-bit integer	Degree of compensation for the 15 th zero-sequence harmonic: 0% ... 100%
0637	cs_harm_h17n	16-bit integer	Degree of compensation for the 17 th zero-sequence harmonic: 0% ... 100%
0638	cs_harm_h19n	16-bit integer	Degree of compensation for the 19 th zero-sequence harmonic: 0% ... 100%
0639	cs_harm_h2_angle	16-bit integer	Angle calibration for the 2 nd harmonic in open-loop. 0 deg ... 359 deg
0640	cs_harm_h3_angle	16-bit integer	Angle calibration for the 3 rd harmonic in open-loop. 0 deg ... 359 deg
0641	cs_harm_h4_angle	16-bit integer	Angle calibration for the 4 th harmonic in open-loop. 0 deg ... 359 deg
0642	cs_harm_h5_angle	16-bit integer	Angle calibration for the 5 th harmonic in open-loop. 0 deg ... 359 deg
0643	cs_harm_h6_angle	16-bit integer	Angle calibration for the 6 th harmonic in open-loop. 0 deg ... 359 deg
0644	cs_harm_h7_angle	16-bit integer	Angle calibration for the 7 th harmonic in open-loop. 0 deg ... 359 deg
0645	cs_harm_h8_angle	16-bit integer	Angle calibration for the 8 th harmonic in open-loop. 0 deg ... 359 deg
0646	cs_harm_h9_angle	16-bit integer	Angle calibration for the 9 th harmonic in open-loop. 0 deg ... 359 deg
0647	cs_harm_h11_angle	16-bit integer	Angle calibration for the 11 th harmonic in open-loop. 0 deg ... 359 deg
0648	cs_harm_h13_angle	16-bit integer	Angle calibration for the 13 th harmonic in open-loop. 0 deg ... 359 deg
0649	cs_harm_h15_angle	16-bit integer	Angle calibration for the 15 th harmonic in open-loop. 0 deg ... 359 deg
0650	cs_harm_h17_angle	16-bit integer	Angle calibration for the 17 th harmonic in open-loop. 0 deg ... 359 deg
0651	cs_harm_h19_angle	16-bit integer	Angle calibration for the 19 th harmonic in open-loop. 0 deg ... 359 deg
0652	cs_harm_h21_angle	16-bit integer	Angle calibration for the 21 st harmonic in open-loop. 0 deg ... 359 deg
0653	cs_harm_h23_angle	16-bit integer	Angle calibration for the 23 rd harmonic in open-loop. 0 deg ... 359 deg
0654	cs_harm_h25_angle	16-bit integer	Angle calibration for the 25 th harmonic in open-loop. 0 deg ... 359 deg
0655	cs_harm_h29_angle	16-bit integer	Angle calibration for the 29 th harmonic in open-loop. 0 deg ... 359 deg
0656	cs_harm_h31_angle	16-bit integer	Angle calibration for the 31 st harmonic in open-loop. 0 deg ... 359 deg
0657	cs_harm_h35_angle	16-bit integer	Angle calibration for the 35 th harmonic in open-loop. 0 deg ... 359 deg
0658	cs_harm_h37_angle	16-bit integer	Angle calibration for the 37 th harmonic in open-loop. 0 deg ... 359 deg
0659	cs_harm_h41_angle	16-bit integer	Angle calibration for the 41 st harmonic in open-loop. 0 deg ... 359 deg

0660	cs_harm_h43_angle	16-bit integer	Angle calibration for the 43 rd harmonic in open-loop. 0 deg ... 359 deg
0661	cs_harm_h47_angle	16-bit integer	Angle calibration for the 47 th harmonic in open-loop. 0 deg ... 359 deg
0662	cs_harm_h49_angle	16-bit integer	Angle calibration for the 49 th harmonic in open-loop. 0 deg ... 359 deg
0663	cs_write_flash	16-bit integer	Write all parameters to flash. Setting this register to 1 will store the complete parameter set, including both primary and secondary compensation set, to flash.

A.4 CT current spectrum registers

This group of registers allows the frequency spectrum of the CT current to be read out.

Address	Register name	Data type	Description
0800 = High data 0801 = Low data	fft_ict_avg_h1	32-bit floating-point	Amplitude of CT current in fundamental frequency (A_{RMS})
0802 = High data 0803 = Low data	fft_ict_avg_h2	32-bit floating-point	Amplitude of CT current in 2 nd harmonic (A_{RMS})
0804 = High data 0805 = Low data	fft_ict_avg_h3	32-bit floating-point	Amplitude of CT current in 3 rd harmonic (A_{RMS})
...
0892 = High data 0893 = Low data	fft_ict_avg_h47	32-bit floating-point	Amplitude of CT current in 47 th harmonic (A_{RMS})
0894 = High data 0895 = Low data	fft_ict_avg_h48	32-bit floating-point	Amplitude of CT current in 48 th harmonic (A_{RMS})
0896 = High data 0897 = Low data	fft_ict_avg_h49	32-bit floating-point	Amplitude of CT current in 49 th harmonic (A_{RMS})

A.5 ADF output current spectrum registers

This group of registers allows the frequency spectrum of the ADF output current to be read out.

Address	Register name	Data type	Description
1000 = High data 1001 = Low data	fft_iadf_avg_h1	32-bit floating-point	Amplitude of ADF current in fundamental frequency (A_{RMS})
1002 = High data 1003 = Low data	fft_iadf_avg_h2	32-bit floating-point	Amplitude of ADF current in 2 nd harmonic (A_{RMS})
1004 = High data 1005 = Low data	fft_iadf_avg_h3	32-bit floating-point	Amplitude of ADF current in 3 rd harmonic (A_{RMS})
...
1092 = High data 1093 = Low data	fft_iadf_avg_h47	32-bit floating-point	Amplitude of ADF current in 47 th harmonic (A_{RMS})
1094 = High data 1095 = Low data	fft_iadf_avg_h48	32-bit floating-point	Amplitude of ADF current in 48 th harmonic (A_{RMS})
1096 = High data 1097 = Low data	fft_iadf_avg_h49	32-bit floating-point	Amplitude of ADF current in 49 th harmonic (A_{RMS})

A.6 Phase voltage spectrum registers

This group of registers allows the frequency spectrum of the phase voltage to be read out.

Address	Register name	Data type	Description
1200 = High data 1201 = Low data	fft_un_avg_h1	32-bit floating-point	Amplitude of phase voltage in fundamental frequency (V_{RMS})
1202 = High data 1203 = Low data	fft_un_avg_h2	32-bit floating-point	Amplitude of phase voltage in 2 nd harmonic (V_{RMS})
1204 = High data 1205 = Low data	fft_un_avg_h3	32-bit floating-point	Amplitude of phase voltage in 3 rd harmonic (V_{RMS})
...
1292 = High data 1293 = Low data	fft_un_avg_h47	32-bit floating-point	Amplitude of phase voltage in 47 th harmonic (V_{RMS})

1294 = High data 1295 = Low data	fft_un_avg_h48	32-bit floating-point	Amplitude of phase voltage in 48 th harmonic (V _{RMS})
1296 = High data 1297 = Low data	fft_un_avg_h49	32-bit floating-point	Amplitude of phase voltage in 49 th harmonic (V _{RMS})

A.7 About registers

This group of registers contains system information such as, software revision/build date, serial number and power modules information.

Address	Register name	Data type	Description
1400	a_build_version_major	16-bit integer	Major part of version number (the 1 in 1.7.0)
1401	a_build_version_minor	16-bit integer	Minor part of version number (the 7 in 1.7.0)
1402	a_build_version_maint	16-bit integer	Maintenance part of version number (the 0 in 1.7.0)
1403	a_build_date_year	16-bit integer	Year of build date (YYYY)
1404	a_build_date_month	16-bit integer	Month of build date (MM)
1405	a_build_date_day	16-bit integer	Day of build date (DD)
1406	a_build_time_hour	16-bit integer	Hour of build time (0-23)
1407	a_build_time_min	16-bit integer	Minute of build time (0-59)
1408	a_build_time_sec	16-bit integer	Second of build time (0-59)
1409 = High data 1410 = Low data	a_serial_number	32-bit integer	SCC2 serial number
1411 = High data 1412 = Low data	a_max_curr_per_ppm	32-bit floating-point	Maximum output current per PPM (A _{RMS})
1413	a_num_ppm	16-bit integer	Number of power modules configured
1414	a_ppm_type	16-bit integer	<p>Power module type:</p> <ul style="list-style-type: none"> 0: PPM300-3-A-100/480 (#0) 1: PPM300-3-A-80/690 (#1) 2: PPM300-3-W-140/690 (#2) 3: PPM300-3-W-150/480 (#3) 4: PPM300-3-A-100/480HC (#4) 5: PPM300-4-A-100/480 (#5) 6: ADF P100-100/480 (#6) 7: ADF P100-70/480 (#7) 8: Reserved (#8) 9: PPM300-3-A-100/480HCB (#9) 10: PPM300-3-W-150/480HCB (#10) 11: PPM300v2-3-A-120/480 (#11) 12: PPM300v2-3-A-90/690 (#12) 13: PPM300v2-3-A-110/480-UL (#13) 14: PPM300v2-3-A-90/600-UL (#14) 15: ADF P100N-100/415 (#15) 16: PPM300v2-3-A-130/480-OEM (#16) 17: PPM300v2-3-A-90/690-OEM (#17) 18: ADF P100v2-90/690 (#18) 19: ADF P100v2-70/480 (#19) 20: ADF P100v2-100/480 (#20) 21: ADF P100v2-130/480 (#21) 22: PPM300v2-3-W-150/480 (#22) 23: PPM300v2-3-W-140/690 (#23) 24: PPM300v2B-3-A-50/480 (#24) 25: PPM300v2B-3-A-75/480 (#25) 26: PPM300v2B-3-A-90/480 (#26) 27: PPM300v2B-3-A-120/480 (#27) 28: PPM300v2B-3-A-150/480 (#28) 29: ADF P100v2B-50/480 (#29) 30: ADF P100v2B-75/480 (#30) 31: ADF P100v2B-90/480 (#31) 32: ADF P100v2B-120/480 (#32) 33: ADF P100v2B-150/480 (#33) 34: PPM300v3-3-A-78/690 (#34) 35: PPM300v3-3-A-130/480 (#35) <p>See Section 4.3.1 for more information about the power module types.</p>



Comsys AB
Fältspatvägen 4
SE-224 78 LUND
Sweden

+46 10 209 68 00
info@comsys.se
adfpowertuning.com

Partner:

Comsys AB does not assume any responsibility for use of any product or method described and also reserves the right to make changes at any time without prior notice in order to improve design and supply the best possible products.