

Right choice for ultimate yield

LSIS strives to maximize customers' profit in gratitude of choosing us for your partner.

# SV-iE5 User Manual

0.1 ~ 0.4 kW (200V)



## Safety Instructions

- Read this manual carefully before installing, wiring, operating, servicing or inspecting this equipment.
- Keep this manual within easy reach for quick reference.

**LS** Industrial Systems

Thank you for purchasing LS Variable Frequency Drives!

## SAFETY INSTRUCTIONS

Safety instructions are prepared to use the product safely and correctly by preventing any accident or risk beforehand, so they should be always kept.

- In this manual, safety instructions are divided into two classes; each has the following meaning.

 **WARNING** Improper operation may result in serious personal injury or death

 **CAUTION** Improper operation may result in slight to medium personal injury or property damage

- Throughout this manual, we use the following two illustrations to make you aware of safety considerations.

 identifies potential hazards under certain conditions.

 identifies shock hazards under certain conditions.

- After reading this manual, keep it handy for any user to quickly refer to
- Read this manual carefully to use SV-iE5 Series Inverter's functions appropriately and safely.

### **Warning**

- Do not remove the cover while the power is applied or the unit is in operation.  
Or, it may cause electric shock.
- Do not run the inverter with the front cover removed.  
Or, it may cause an electric shock due to high voltage terminals or charged capacitor exposure.
- Do not remove the cover except for periodic inspections or wiring, even if the input power is not applied.  
Or, it may cause an electric shock due to charged capacitor exposure even if the power is cut off.
- Wiring and periodic inspections should be performed at least 10 minutes after disconnecting the input power and after checking the DC link voltage is discharged with a meter (below DC 30V).  
Or, it may cause an electric shock (below DC 30V)
- Operate the switches with dry hands.  
Or, it may cause an electric shock.
- Do not use the cable when its insulating tube is damaged.  
Or, it may cause an electric shock.
- Do not subject the cables to any heavy load stressful to them.  
Or, it may cause an electric shock due to damaged cable.

 **Caution**

- Install the inverter on a non-flammable surface.  
Or, it may cause a fire if being installed on or closely to a flammable material.
- Disconnect the input power if the inverter gets damaged.  
Or, it may result in a secondary accident and fire.
- After the input power is applied or removed, the inverter will remain hot for a couple of minutes.  
Otherwise, you get bodily injuries such as skin-burn or damage.
- Do not apply power to a damaged inverter or an inverter with parts missing even if the installation is complete.  
Or, it may cause an electric shock.
- Do not allow screw, metal chips, water drops, oil or other impurities into the inverter.  
Or, it may cause a fire.

**Operating Precautions**

(1) Transport and installation

- Carry it correctly according to the specified weight.
- Do not stack the inverter boxes higher than recommended.
- Install according to instruction specified in this manual.
- Do not open the cover during transport.
- Do not place any heavy load on the inverter.
- Check whether the inverter mounting direction is correct.
- Do not drop the inverter, or subject it to impact.
- Follow your national electrical code for grounding(200V).
- As soon as detaching PCB(Printed Circuit Board) for installation or repair, make sure to place it on conductor.  
Otherwise, it may cause destruction due to static electricity.
- Use the inverter under the following environmental conditions.

Environment	Ambient temperature	- 10 ~ 40 °C (non-freezing)
	Relative humidity	90% RH or less (non-condensing)
	Storage temperature	- 20 ~ 65 °C
	Service condition	Free of any corrosive gas, combustible gas, oil mist or dust
	Altitude, vibration	Max. 1,000m above the sea level · 5.9m/sec <sup>2</sup> (=0.6g) or less

### (2) Wiring

- Do not connect a power factor correction capacitor, surge suppressor, or RFI filter to the output of the inverter.
- The connection orientation of the output cables should be in good order of U, V, W.
- Incorrect terminal wiring could result in the equipment damage.
- Reversing the polarity (+/-) of the terminals could damage the inverter.
- The only authorized and skilled person should perform wiring and inspections.
- Always install the inverter before wiring.

### (3) Trial run

- Check all parameters during operation. Changing parameter values might be required depending on the load.
- Always apply permissible range of voltage to the each terminal as indicated in this manual. Otherwise, it could lead to inverter damage.

### (4) Operation precautions

- Note that if the Auto restart function is selected, you must stay away from the equipment as a motor will restart suddenly after an alarm stop.
- The Stop key on the keypad is activated only when the setting has been made. Prepare an emergency stop switch separately.
- If any fault is reset with the reference signal present, a sudden start will automatically occur. Check that the reference signal is turned off in advance. Otherwise an accident could occur.
- Do not modify or alter the inverter without permission.
- Do not use a magnetic contactor on the inverter input for frequent starting/stopping of the inverter.
- Use a noise filter to reduce the effect of electromagnetic interference. Otherwise nearby electronic equipment may be affected.
- In case of input voltage unbalance, install AC reactor. Power Factor capacitors and generators may become overheated and damaged due to potential high frequency noise transmitted from inverter.
- Before operating unit and prior to user programming, reset user parameters to default settings.
- Inverter can easily be set to high-speed operations, Verify capability of motor or machinery prior to operating unit.
- Stopping torque is not produced when using the DC-Break function. Install separate equipment when stopping torque is needed.

### (5) Fault prevention precautions

- Provide a safety backup such as an emergency brake which will prevent the machine and equipment from hazardous conditions if the inverter fails.

### (6) Maintenance, inspection and parts replacement

- Do not conduct a megger (insulation resistance) test on the control circuit of the inverter.
- Refer to Chapter 13 for periodic inspection (parts replacement).

(7) Disposal

- Dispose of the inverter as treating industrial waste.

(8) General instructions

- Many of the diagrams and drawings in this instruction manual show the inverter without a circuit breaker, a cover or partially open. Never run the inverter like this. Always place the cover with circuit breakers and follow this instruction manual when operating the inverter.

## Instructions

### User's Manual

- The purpose of this manual is to provide the user with the necessary information to install, program, start up and maintain the SV-iE5 series inverter.
- To assure successful installation and operation of the SV-iE5 series inverter, the material presented must be thoroughly read and understood before proceeding
- This manual contains...

Ch.	Title	Description
1	Basic information & Precautions	Provides general information and precautions for safe use of the inverter.
2	Installation	Provides instructions on how to install the SV-iE5 inverter.
3	Wiring	Provide the information on how to wire the input power and signal terminal strip
4	Peripheral	Describes how to connect the optional peripheral devices to the inverter.
5	Loader	Illustrates keypad features and display.
6	Basic Operation	Provides instructions for quick start of the inverter.
7	Function List	Summarized table of functions.
8	Control Block Diagram	Shows control flow to help users easily understand operation mode.
9	Basic Functions	Provides information on basic functions such as frequency setup and operation commands.
10	Advanced Functions	Indicates advanced functions used for system application.
11	Monitoring	Gives information on the operating status and fault information.
12	Protective Functions	Outlines protective functions of the motor and the inverter.
13	Troubleshooting & Maintenance	Provides information on potential troubles or abnormal situations.
14	COM Options	Gives information on the inverter mounting with communication options.
15	Specifications	Gives information on Input/Output rating, control type and more details of the SV-iE5 inverter.

## Contents

1.	Basic Information & Precaution .....	1-1
1.1	Important precautions .....	1-1
1.2	Parts' Names & Details .....	1-2
1.3	Assembling & Disassembling.....	1-3
2.	Installation .....	2-1
2.1	Installation precautions .....	2-1
2.2	Dimensions.....	2-4
3.	Wiring.....	3-1
3.1	Control Terminal Wiring Diagram.....	3-1
3.2	Power Terminal Wiring Diagram .....	3-1
3.3	Grounding Specification .....	3-2
3.4	Control Terminal Wiring Specification .....	3-3
3.5	PNP/NPN Modes Switch.....	3-4
4.	Peripheral.....	4-1
4.1	Configuration of Peripherals .....	4-1
4.2	Recommended MCCB and Magnetic Contactor .....	4-2
4.3	Recommended Reactors .....	4-2
5.	Loader .....	5-1
5.1	Configuration .....	5-1
5.2	Alpha-numeric view on the LED .....	5-2
5.3	Moving to other groups .....	5-3
5.4	How to move among codes in a group.....	5-4
5.5	How to set parameters.....	5-7
5.6	Monitoring Operation Status .....	5-9
6.	Basic Operation .....	6-1
6.1	Frequency Setting and Basic Operation.....	6-1
7.	Function List.....	7-1
8.	Control Block Diagram.....	8-1
8.1	Control Flow .....	8-1
8.2	Frequency Setting & Drive Mode Setting .....	8-1
8.3	Frequency Setting, Drive Acc./Dec. Setting and V/F Voltage Control.....	8-2
9.	Basic Functions.....	9-1
9.1	Frequency Setting .....	9-1
9.2	Multi-Step Frequency Setting.....	9-4
9.3	Operating command setting method.....	9-5
9.4	Accel/Decel time and pattern setting .....	9-8

## Contents

9.5	V/F Control .....	9-11
9.6	Stop method select.....	9-14
9.7	Frequency limit.....	9-15
10.	Advanced Functions .....	10-1
10.1	DC Brake.....	10-1
10.2	Jog operation.....	10-3
10.3	UP – DOWN operation.....	10-4
10.4	3-Wire operation.....	10-5
10.5	Dwell operation .....	10-5
10.6	Slip Compensation Control .....	10-6
10.7	PI Control .....	10-8
10.8	Speed search operation .....	10-10
10.9	Auto Restart Operation .....	10-12
10.10	Operation Sound Select (carrier frequency change).....	10-13
10.11	Parameter initialize/Lock.....	10-13
11.	Monitoring .....	11-1
11.1	Operating Status Monitoring .....	11-1
11.2	Monitoring I/O Terminal.....	11-3
11.3	Monitoring Fault Condition .....	11-3
11.4	Analogue output.....	11-5
11.5	Multi-function output terminal and Relay .....	11-6
12.	Protective Function .....	12-1
12.1	Overload Trip.....	12-1
12.2	Stall prevention.....	12-1
12.3	User's fault detection .....	12-2
12.4	External trip signal.....	12-3
12.5	Frequency command loss.....	12-4
12.6	Inverter overload .....	12-5
13.	Troubleshooting and Maintenance .....	13-1
13.1	Protective Functions.....	13-1
13.2	Fault Remedy .....	13-3
13.3	Precautions for maintenance .....	13-5
13.4	Checklist.....	13-5
13.5	Parts Replacement.....	13-5
14.	COM Option (RS-485).....	14-1
14.1	Introduction.....	14-1
14.2	Specifications .....	14-1
14.3	Installation .....	14-2



## Contents

---

14.4	Inverter functional code setting .....	14-3
14.5	Operation.....	14-4
14.6	COM Protocol(ModBus-RTU) .....	14-4
14.7	Parameter code list .....	14-5
14.8	Troubleshooting.....	14-11
15.	Specifications .....	15-1
15.1	Technical data .....	15-1

## 1. Basic Information & Precaution

### 1.1 Important precautions

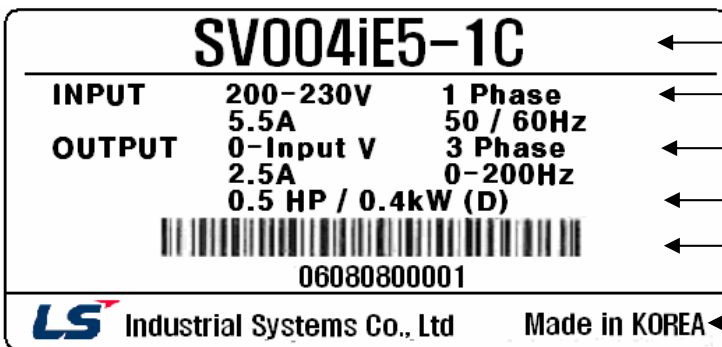
<p>Unpacking &amp; Inspection</p>	<p>Unpack the package and check the inverter type, output ratings on the nameplate and whether the inverter is intact. In addition, inspect the inverter for any damage that may have occurred during shipping.</p> <div style="text-align: center;">  </div> <p style="text-align: center;">SV 004                      iE5                      - 1                      C</p> <table border="1" style="width: 100%; border-collapse: collapse;"> <thead> <tr> <th colspan="2">Motor rating</th> <th>Series name</th> <th colspan="2">Input power</th> <th colspan="2">RS-485 option</th> </tr> </thead> <tbody> <tr> <td>001</td> <td>0.1 [kW]</td> <td rowspan="3">Extra small commercial inverter</td> <td>1</td> <td>Single phase 200V</td> <td>C</td> <td>No option</td> </tr> <tr> <td>002</td> <td>0.2 [kW]</td> <td>2</td> <td>3 Phases 200V</td> <td>-</td> <td>No option</td> </tr> <tr> <td>004</td> <td>0.4 [kW]</td> <td></td> <td></td> <td></td> <td></td> </tr> </tbody> </table> <p>● Accessories</p> <p>If you have found any discrepancy, damage, etc., contact your dealer or sales representative (refer to the rear cover page of this manual).</p>	Motor rating		Series name	Input power		RS-485 option		001	0.1 [kW]	Extra small commercial inverter	1	Single phase 200V	C	No option	002	0.2 [kW]	2	3 Phases 200V	-	No option	004	0.4 [kW]				
Motor rating		Series name	Input power		RS-485 option																						
001	0.1 [kW]	Extra small commercial inverter	1	Single phase 200V	C	No option																					
002	0.2 [kW]		2	3 Phases 200V	-	No option																					
004	0.4 [kW]																										
<p>Preparations of instruments and parts required for operation</p>	<p>Instruments and parts to be prepared depend on how the inverter is operated. Prepare optional (additional) equipments and parts as necessary.</p>																										
<p>Installation</p>	<p>To operate the inverter with high performance for a long time, install the inverter considering a proper place and the correct direction with proper clearances.</p>																										
<p>Wiring</p>	<p>Connect the power supply, motor and operation signals (control signals) to the terminal block. Note that incorrect connection may damage the inverter and peripheral devices.</p>																										

1.2 Parts' Names & Details

● Appearance

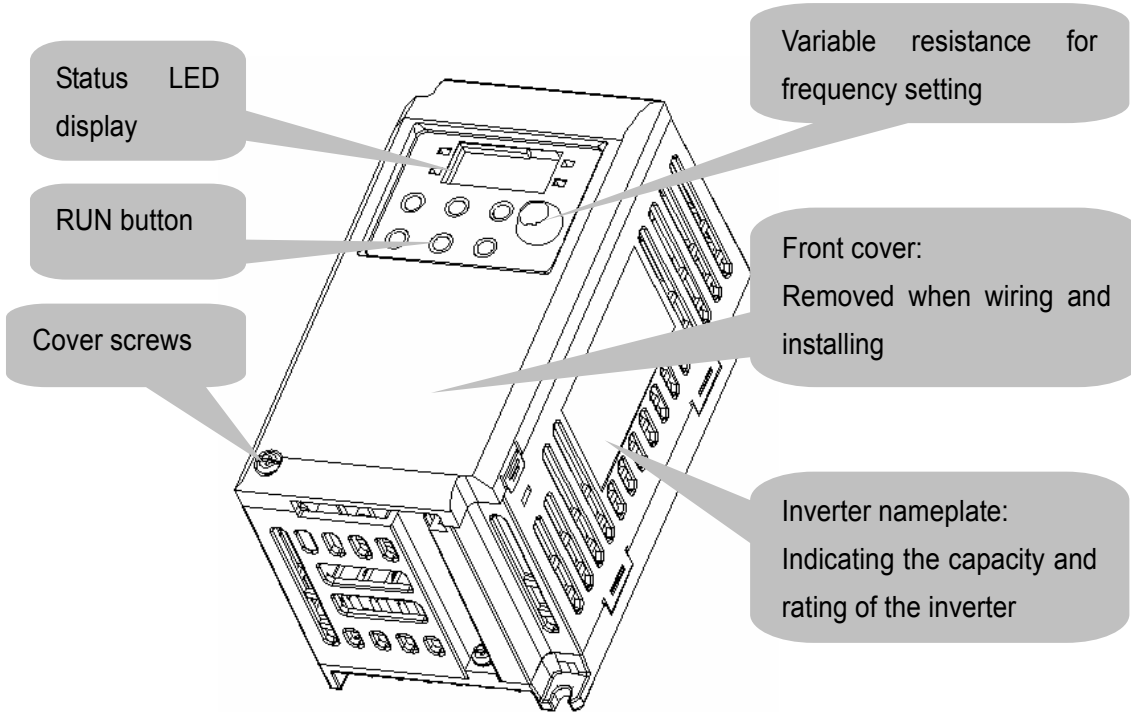

● Inside view with front cover removed

Refer to 1.3 for details when remove front cover.

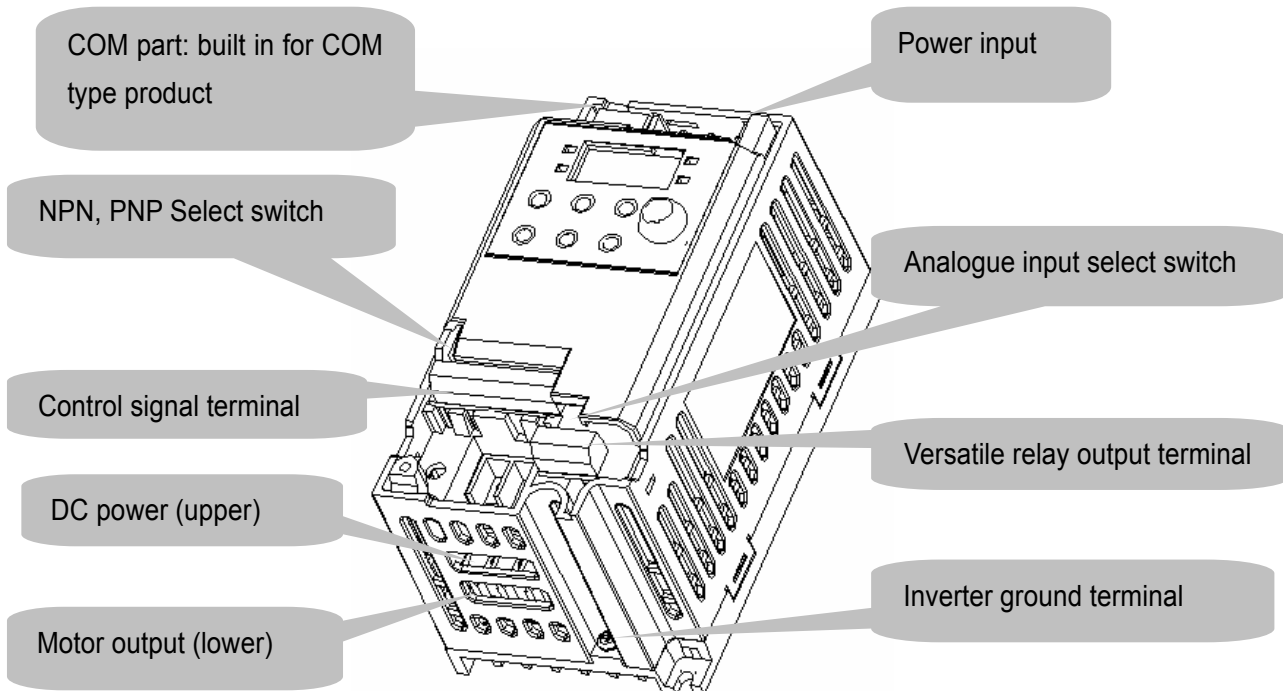

### 1.3 Assembling & Disassembling

- To remove the front cover, press both indented sides of the cover lightly and pull it up.

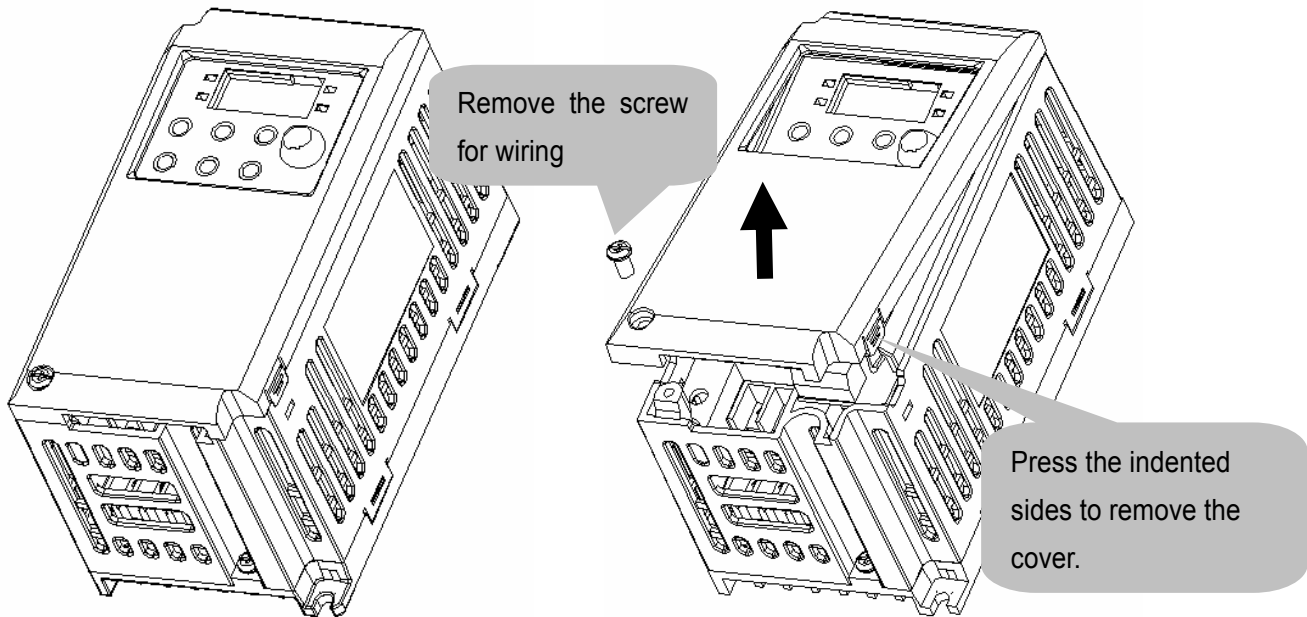

- The front cover is completely removed if lifting it up and removing the fixed part. Wiring and installation is available only with the cover removed.

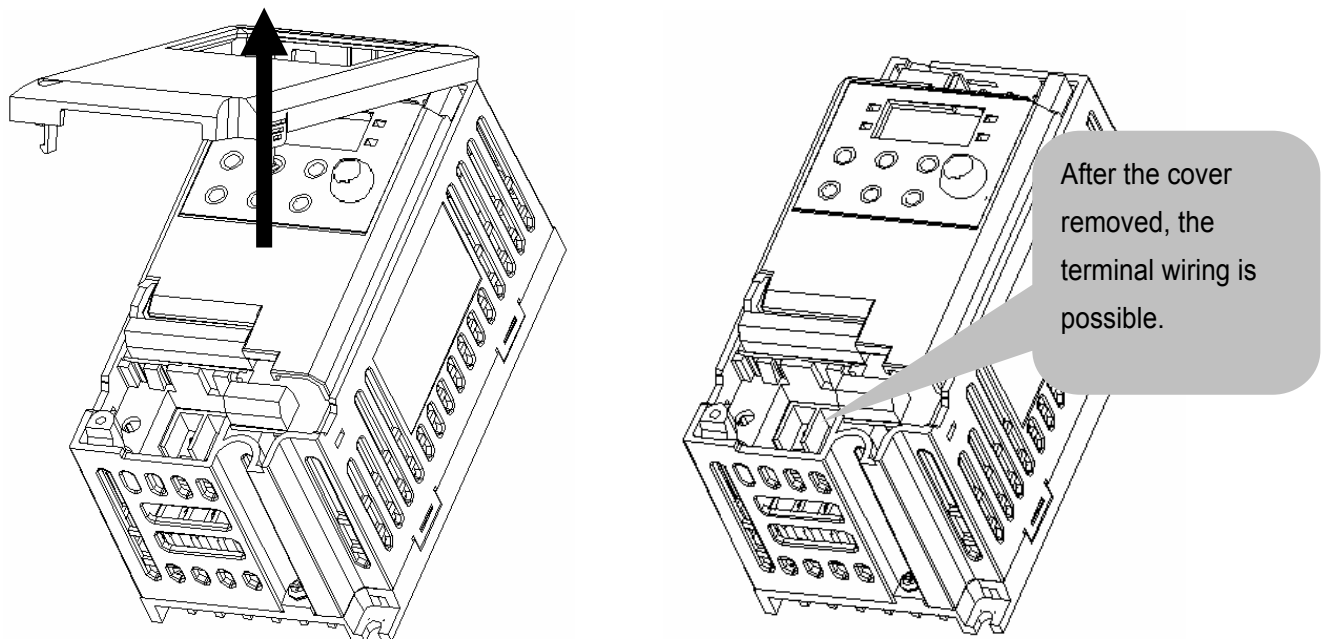

**Caution** For the control terminal, use the cables presented in this manual. Using a thicker one than the reference type may interfere with assembling or subject the cable sheath to damage.

**M E M O**

## 2. Installation

### 2.1 Installation precautions

#### ! CAUTION

- Handle the inverter with care to prevent the plastic components damaged.
- Avoid installing the inverter in a place where vibration from bogie or press exists.
- Install in a location where ambient air temperature is within the permissible range (-10 ~ 40°C).
- Maximum Surrounding Air Temperature of 40 °C (UL508C)

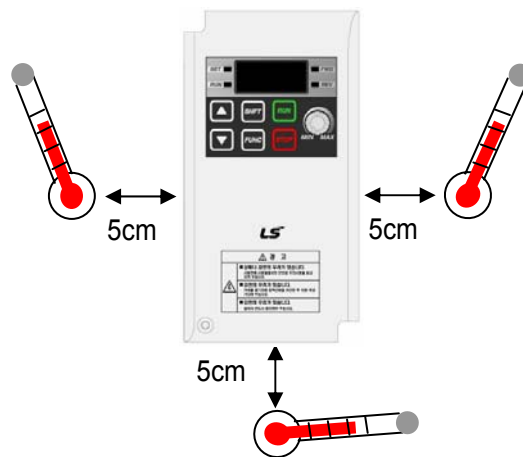

< Ambient air Temp Checking Location >

- The inverter will be very hot during operation. Install it on a flame-retardant surface.
- Inverter is a heating source, so the installation place needs enough space for proper heat dissipation
- In case installed in a panel without ventilating opening, secure space as presented in Figure 1.
- If the inverters are installed in a row, make sure to leave space between and among them as seen in Figure 2.  
Note that side space may vary depending on a panel's cooling efficiency.

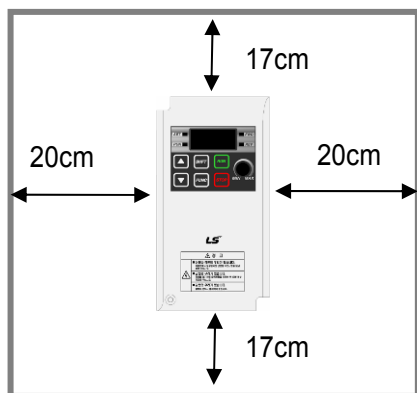

[Figure 1]

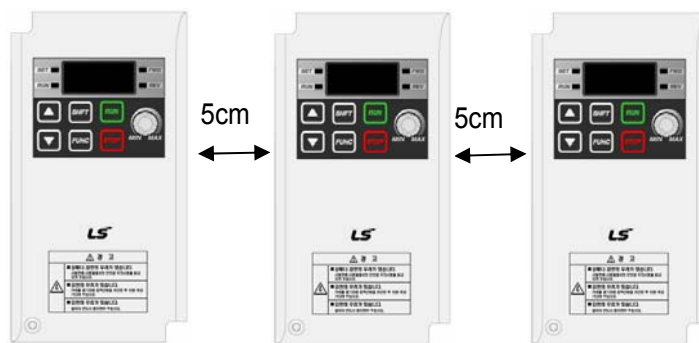



[Figure 2]

- Protect from high temperature and high moisture and/or direct sunlight.
- Install the inverter inside a "totally enclosed" panel to protect against oil mist, water or dust.

- When two or more inverters are installed inside a panel, the inverters and fans must be installed in proper positions with extreme care.
- Install the inverter using screws or bolts to insure the inverter is firmly fastened.

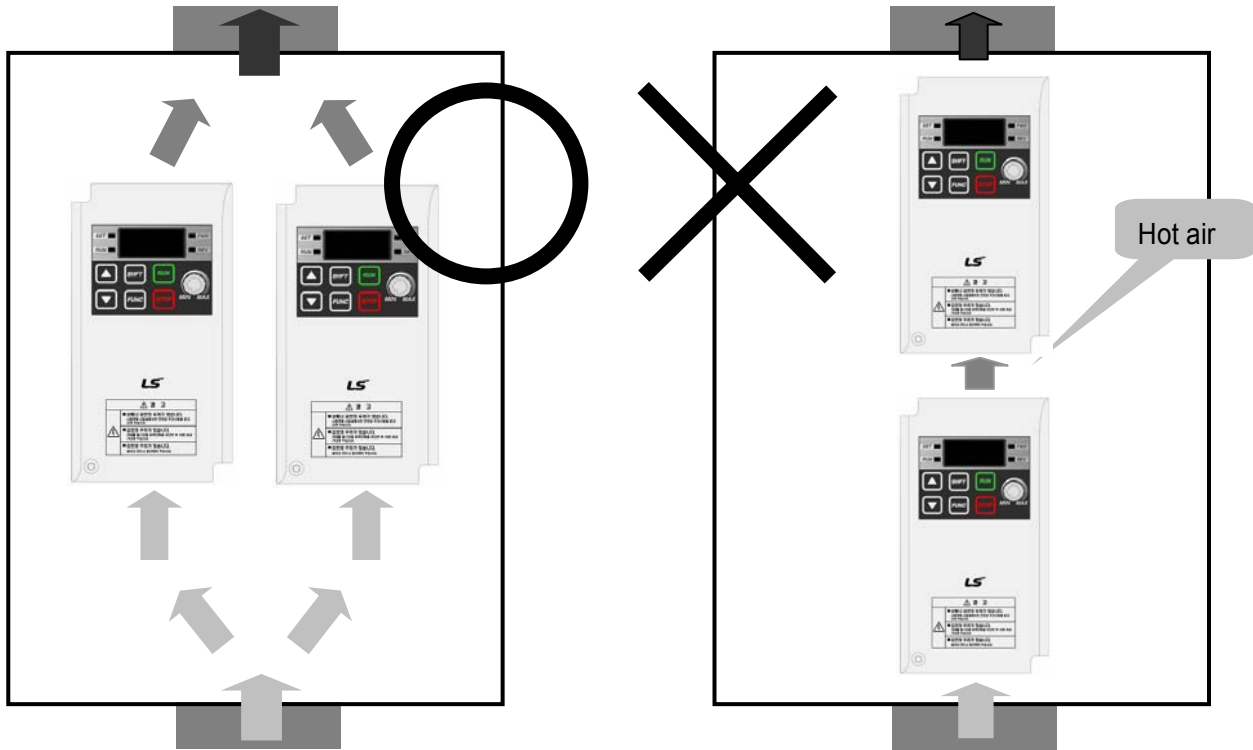
< For installing multiple inverters in a panel >



 **Caution** Arrange hot air from the inverters is discharged when installing them on a panel. 'X' shows incorrect layout example.

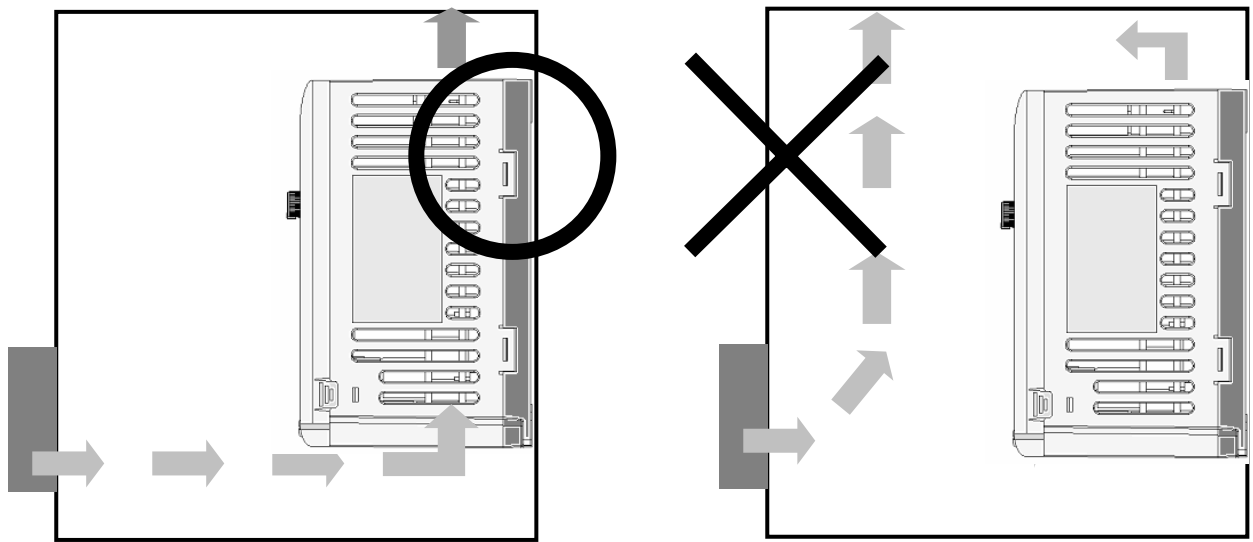

 **Caution** A fan is to be installed so that the air inside the inverter is well discharged as seen in the left figure. 'X' shows an example of reduced cooling effect, possibly causing the inverter to overheat.

**Warning**

- Follows procedure below when Install the inverter for successful operation.

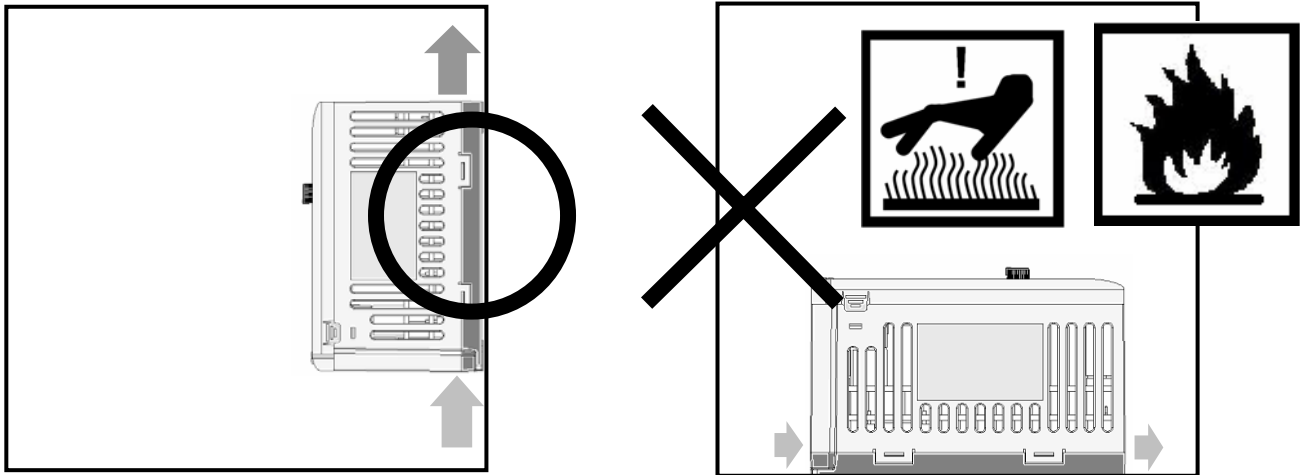

**Caution** iE5 has self cooling structure using air. Therefore install the inverter vertically possible to air circulation. Malfunction or fire may be caused when installed horizontally.

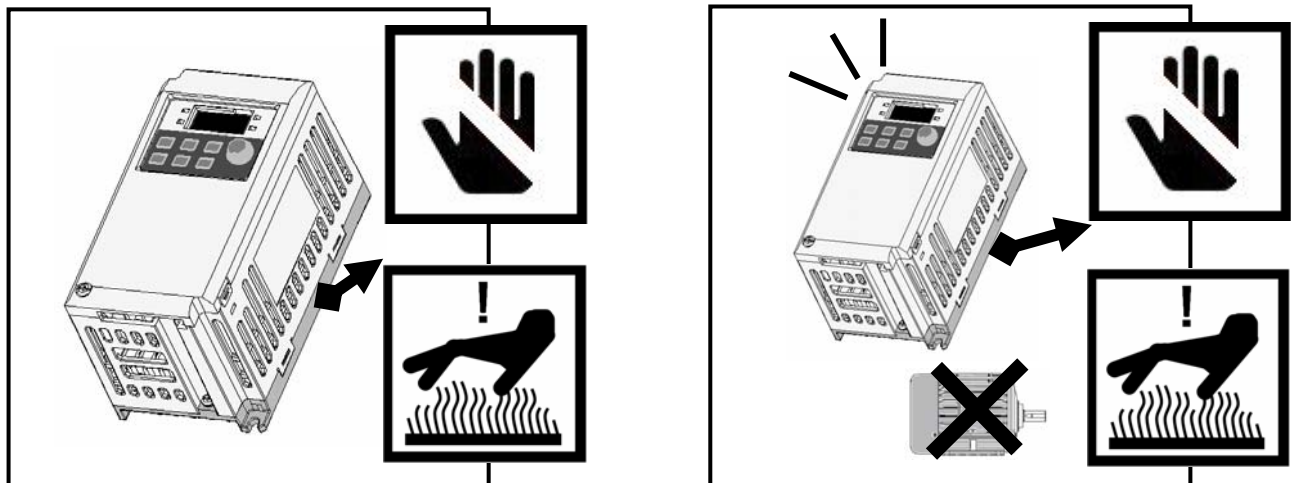

**Caution**

- Heat protection pin of iE5 is a high heating element. Caution to contact while operate the products.
- Since switching heat occurs when inverter output without connection motors, Do not operate inverter independently. Skin burn or malfunction may be caused.



2.2 Dimensions

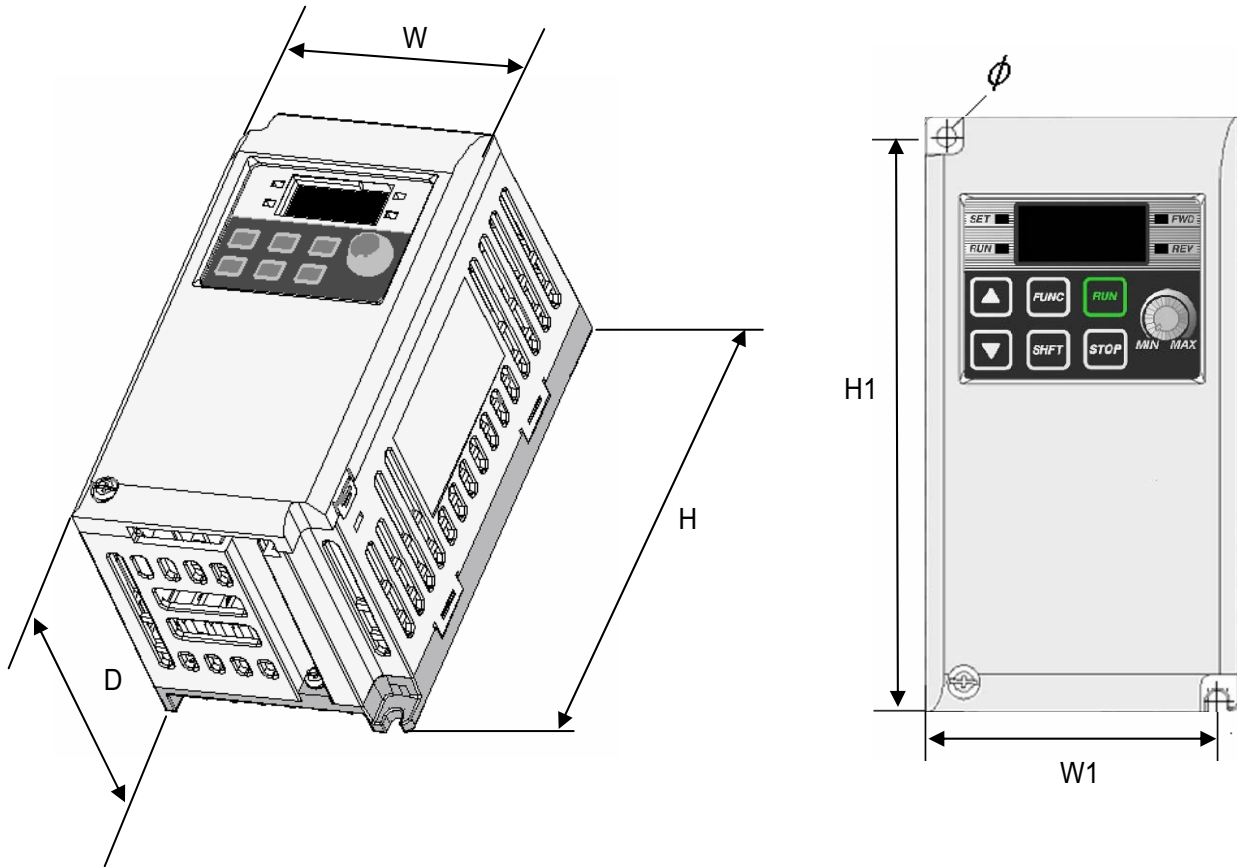

Inverter	001iE5-1	002iE5-1	004iE5-1	001iE5-2	002iE5-2	004iE5-2
W	68	68	68	68	68	68
H	128	128	128	128	128	128
D	85	85	115	85	85	115
H1	124	124	124	124	124	124
W1	64	64	64	64	64	64
φ	4.2	4.2	4.2	4.2	4.2	4.2
Weight(kg)	0.44	0.46	0.68	0.43	0.45	0.67

**Note**

Use M4 screw for fixing the inverter on a panel.

### 3. Wiring

#### 3.1 Control Terminal Wiring Diagram

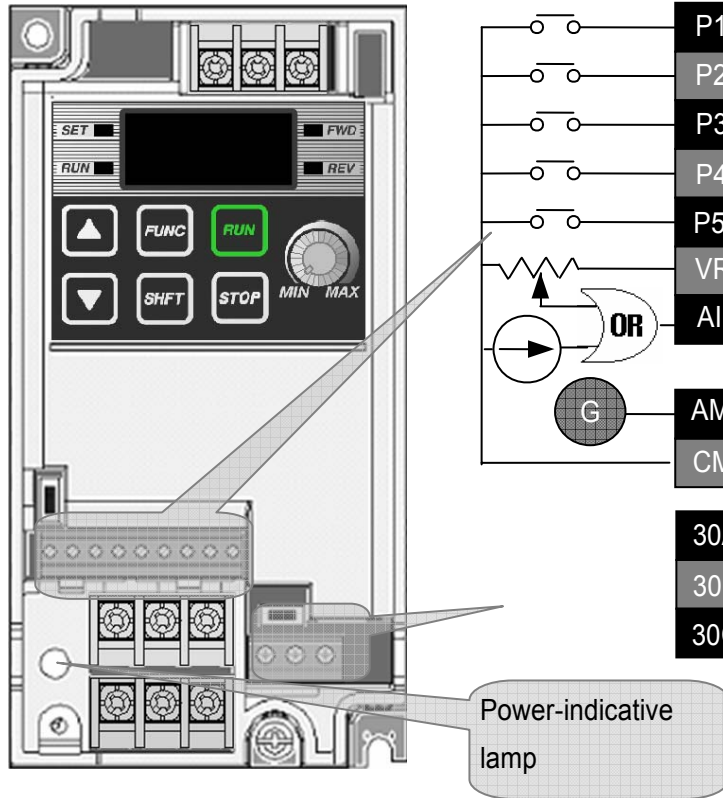

T/M	Description	
P1	Multi function terminal	FX : forward run
P2		RX : reverse run
P3		EST : emergency stop
P4		RST : trip reset
P5		JOG : jog operation
VR	12V power(12V,100mA) for external volume	
AI	Analogue frequency input(Voltage or current)	
AM	Analogue output: 0 ~ 10V	
CM	Input signal common	
30A	Multi function relay output terminal	A contact output
30B		B contact output
30C		A/B contact common

**Note**  
Refer to page 3-3 for the dimensions of the control terminal

#### 3.2 Power Terminal Wiring Diagram

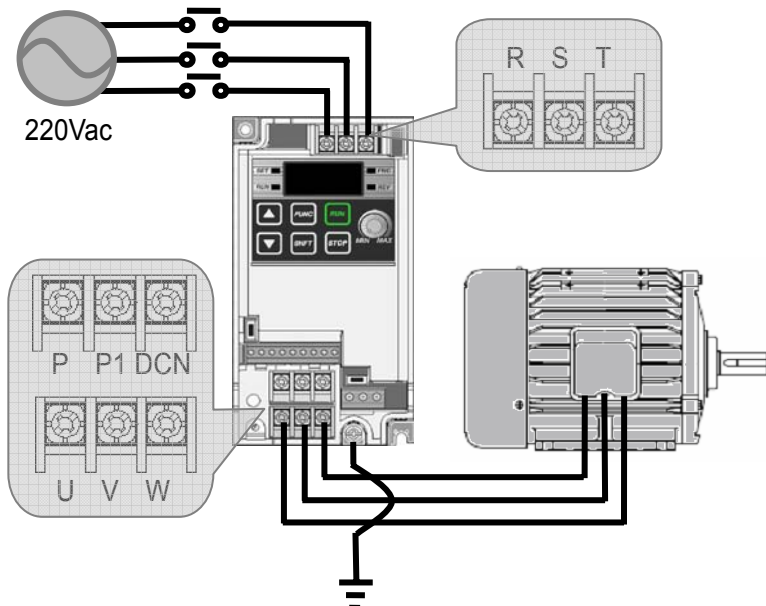

0.1~0.4kW IE5 Power Terminal Spec.	
I wire thickness	16AWG, 1.25 mm <sup>2</sup>
O wire thickness	16AWG, 1.25 mm <sup>2</sup>
G wire thickness	14AWG, 1.25 mm <sup>2</sup>
I/O terminal	16AWG, 1.25 mm <sup>2</sup> /3.5 φ
Terminal torque	3.5 lb-in

**Caution** In case of single phase, the input power should be connected to R, S terminals. If connected to T phase, the inverter does not work.

**CAUTION**

- Suitable For Use On A Circuit Capable of Delivering Not More Than 5000 RMS Symmetrical Amperes, 240 Volts Maximum. (UL508C)
- Use Copper Conductors Only, 75 °C only with a torque rating. (UL508C)
- Make sure the input power is off before wiring.
- When the inverter's input power is cut off after operation, wire it after DC circuit voltage inside the inverter is fully discharged by measuring P1 and N with a tester (voltmeter). If there is no tester, wire it after the power lamp is completely out.
- Applying input power supply to the output terminals U, V and W causes internal inverter damage.
- Use ring terminals with insulated caps when wiring the input power and motor wiring
- Do not leave wire fragments inside the inverter. it can cause faults, breakdowns and malfunctions.
- Never short P1 or P with N. Shorting terminals may cause internal inverter damage
- Do not connect static condenser, surge killer or radio noise filter to the output of the inverter. Otherwise, the inverter's protection function starts working or it may cause condenser or surge suppressor broken.
- The inverter is delivered that P~P1 are connected to short circuit

**3.3 Grounding Specification**

**WARNING**

- Use the Type 3 grounding method (Ground impedance: Below 100Ω).
- Use the dedicated ground terminal to ground the inverter. Do not use the screw in the case or chassis, etc for grounding.

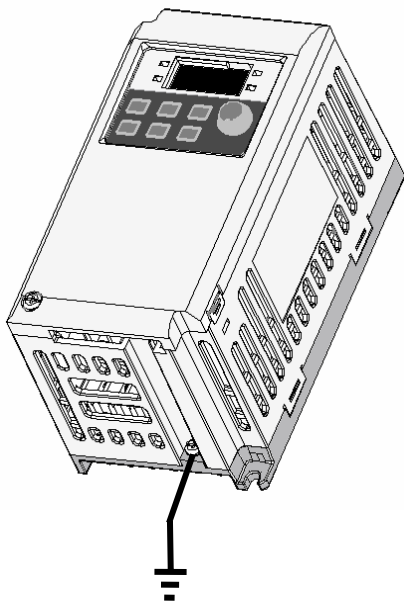

**Note**

- Grounding procedure
  - 1) Remove the front cover.
  - 2) Connect the Grounding wire to the ground terminal as shown above

**CAUTION**

Follow the grounding specifications.

Inverter Cap.	001iE5, 002iE5, 004iE5 – 1,2
Wire size	14AWG, 2mm <sup>2</sup>
Lug spec.	14AWG, 2mm <sup>2</sup> , 4φ
Grounding method	Special type 3

3.4 Control Terminal Wiring Specification

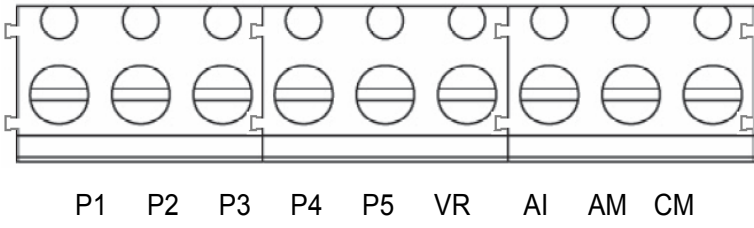
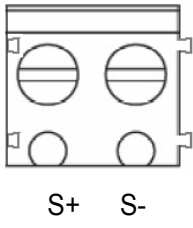
Terminal description			COM optional terminal	
				
T/M	Terminal description	Wire size	Torque [lb-in]	Remarks
P1~P5	Multi-function input T/M 1-5	22 AWG,0.3 mm <sup>2</sup>	3.0	
VR	Power T/M for external volume resistance	22 AWG,0.3 mm <sup>2</sup>	3.0	
AI	Analogue frequency input T/M	22 AWG,0.3 mm <sup>2</sup>	3.0	
AM	Multi-function output T/M	22 AWG,0.3 mm <sup>2</sup>	3.0	
CM	Common terminal	22 AWG,0.3 mm <sup>2</sup>	3.0	

Multi-function Relay T/M Spec.

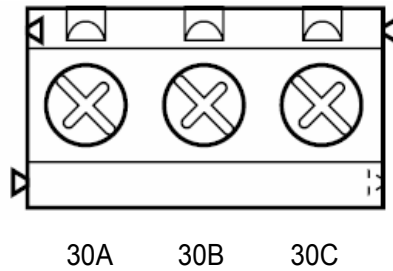

T/M	Terminal description	Wire size	Torque[lb-in]	Remarks
30A	Multi-function relay output A contact	20 AWG,0.5 mm <sup>2</sup>	4.5	
30B	Multi-function relay output B contact	20 AWG,0.5 mm <sup>2</sup>	4.5	
30C	Common for Multi-function relays	20 AWG,0.5 mm <sup>2</sup>	4.5	

 **CAUTION**

Tie the control wires more than 15cm away from the control terminals. Otherwise, it interferes with front cover reinstallation.

**Note**

When you use external power supply (24V) for multi-function input terminal (P1~P5), terminals will be active above 12V level. Take caution not to drop the voltage below 12V.

### 3.5 PNP/NPN Modes Switch

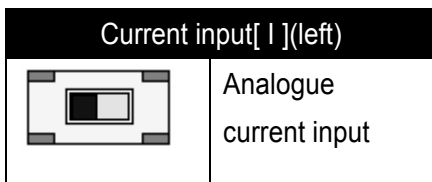
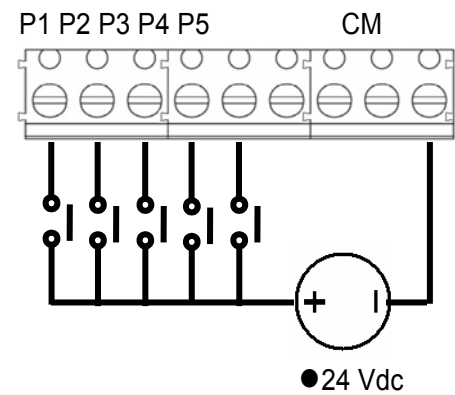
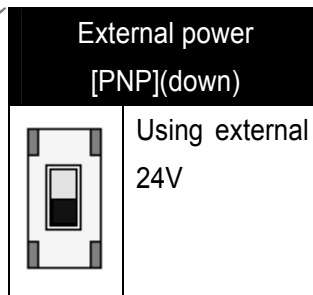
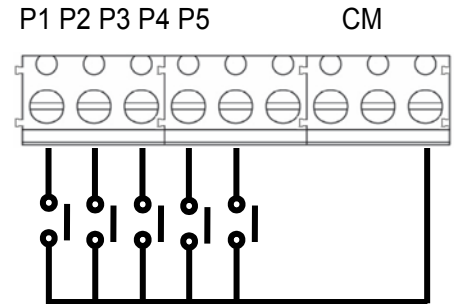
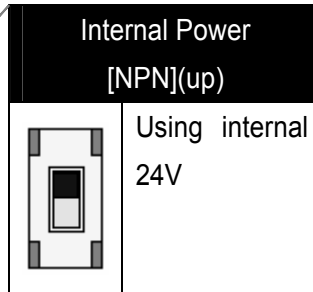
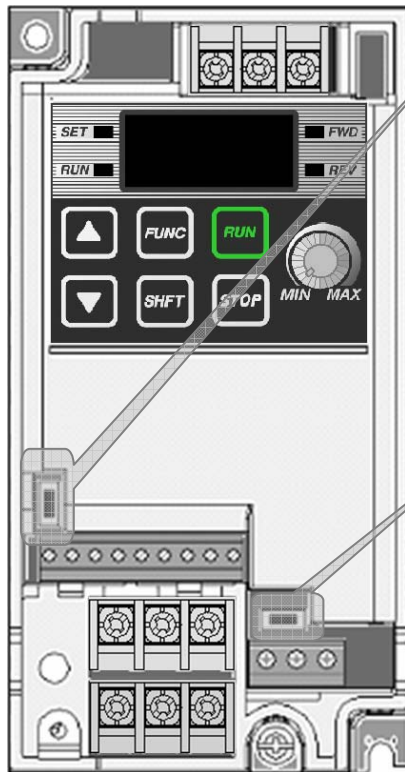

1) Using external current

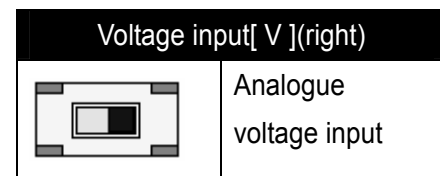
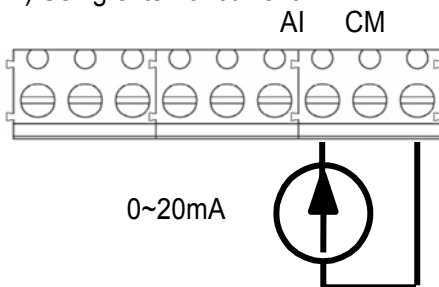

2) Using external voltage

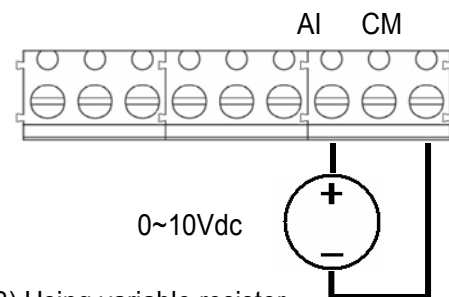

3) Using variable resistor

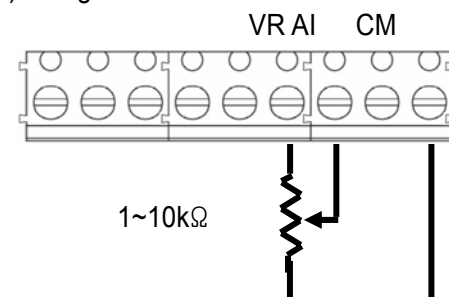

**Note**





The setting direction of switch in the above figure is in black.

## 4. Peripheral

### 4.1 Configuration of Peripherals

Correct peripherals must be selected and properly connected. An incorrectly applied or installed inverter may result in system malfunction or reduction in product life as well as component damage. You must read and understand this manual thoroughly before proceeding.

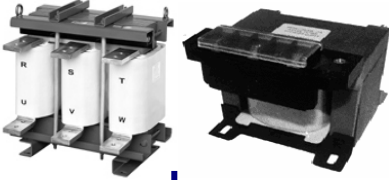
● AC power input

Peripheral	Name	Caution
	Input power	Use the power supply within the permissible range of inverter input power rating (Refer to Page 15-1).
	MCCB or ELB	Select circuit breakers with care. A large inrush current may flow in the inverter at power on.
	Magnetic contactor	Install it if necessary. When installed, do not use it for the purpose of starting or stopping. Otherwise, it may cause the reduction of product life.
	AC or DC reactors	The reactors must be used when the power factor is to be improved or the inverter is installed near a large power supply system (20times and more than its cap. and wiring distance within 10m).
	Installation and wiring	Maintain the ambient temperature within the permissible range because the life is sensitive to the temperature. Incorrect terminal wiring could result in equipment damage.
	Inverter output	Do not connect a static condenser, surge suppressor or radio noise filter to the output side of the inverter.

**4.2 Recommended MCCB and Magnetic Contactor**

Model	MCCB	ELB(LS)		MC		Remarks
001iE5-1	ABS33b	5A	EBS33b	5A	GMC- 9	7A
002iE5-1		10A		10A	GMC-12	9A
004iE5-1		15A		15A	GMC-18	13A
001iE5-2		3A		3A	GMC- 9	7A
002iE5-2		5A		5A	GMC- 9	7A
004iE5-2		10A		10A	GMC-12	9A

**4.3 Recommended Reactors**

Model	AC Input fuse	AC reactor	DC reactor
001iE5-1	20A	4.2mH, 3.5A	10mH, 3A
002iE5-1	20A	4.2mH, 3.5A	10mH, 3A
004iE5-1	20A	5.1mH, 5.4A	7mH, 5A
001iE5-2	20A	4.2mH, 3.5A	10mH, 3A
002iE5-2	20A	4.2mH, 3.5A	10mH, 3A
004iE5-2	20A	4.2mH, 3.5A	7mH, 5A

## 5. Loader

### 5.1 Configuration

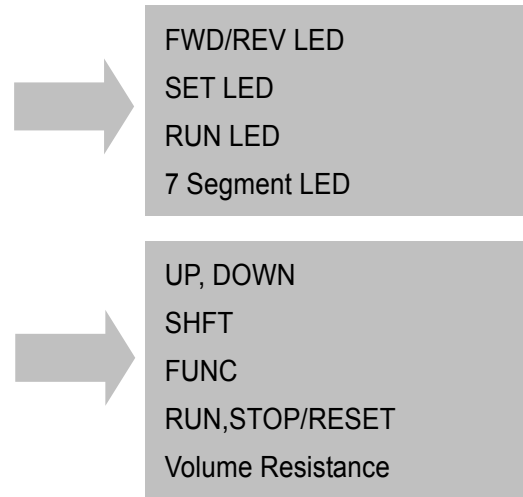

**Note**

STOP key of the inverter iE5 also contains reset function, which is used to cancel trip. Trip may be cancelled by using this key.

Display	Description	
FWD	'On' during forward run	Blinks when a fault occurs
REV	'On' during reverse run	
SET	'On' during parameter setting	
RUN	'On' during inverter operation	
7 Segments	Displaying operation status and parameter information	

Key	Name	Description
▲	Up	Scroll through codes or increase parameter value
▼	Down	Scroll through codes or decrease parameter value
RUN	Run	Operation command
STOP	Stop	STOP : stop during operation, RST : reset in case of fault
FUNC	Function	Edit parameters or save edited parameter values
SHFT	Shift	Move among groups/the number of ciphers left during parameter setting
Volume resistance		Used to change driving frequency



5.2 Alpha-numeric view on the LED

Refer to the below table summarizing the characters displayed on the LED.

Inverter LED	No.	Inverter LED	Eng	Inverter LED	Eng	Inverter LED	Eng
0	0	A	A	K	K	U	U
1	1	b	B	L	L	v	V
2	2	c	C	m	M	w	W
3	3	d	D	n	N	x	X
4	4	E	E	o	O	y	Y
5	5	F	F	p	P	z	Z
6	6	G	G	q	Q		
7	7	H	H	r	R		
8	8	i	I	s	S		
9	9	J	J	t	T		

**Note**  
 Inverter iE5 uses 7-segment display. Therefore, it displays numbers and alphabet as the above table. Make sure to fully comprehend them for reading the fault messages/functional information.

**Note**  
 The 7-Segment operates in three statuses; on, off and blink. Throughout this manual, on is in black, blank is in grey and off is not separately presented.

i.e.)

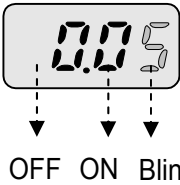

The diagram shows a 7-segment display with the number '0.05' displayed. The first '0' is in black, the second '0' is in grey, and the '5' is in black. Three dashed arrows point downwards from the display to the labels 'OFF', 'ON', and 'Blink' respectively.

### 5.3 Moving to other groups

- There are two different parameter groups in SV-iE5 series as shown below.

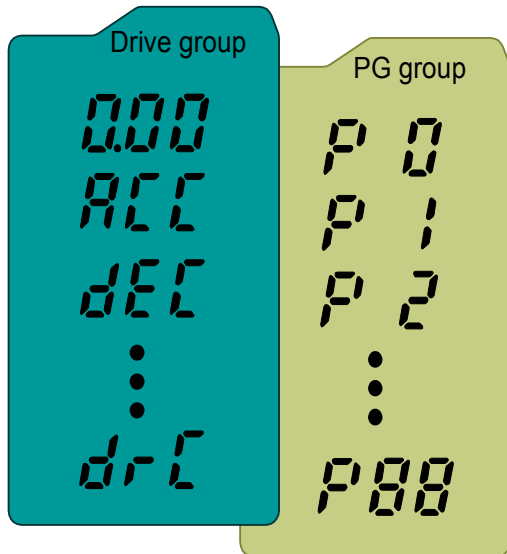

Type	Description
Drive group	Basic parameters necessary to operate the inverter; target frequency, acceleration/deceleration time and etc.
PG group	Parameter group for additional functions

#### Moving to the other parameter group

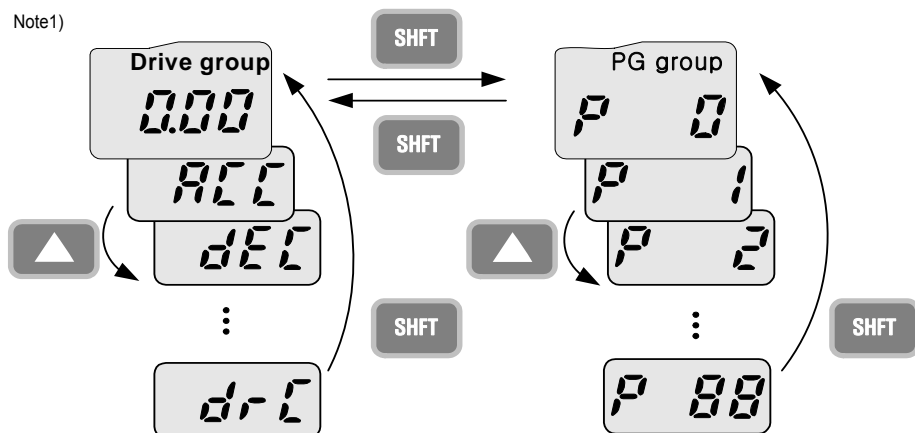

Can move between groups if pressing SHFT key in code 0 of Drive Group/PG Group as shown in the figure. If pressing SHFT in other codes but 0, it moves to the first code of a selected group and it moves between groups if pressing SHFT once more.

1) Target frequency is set in the first code of Drive Group. It is delivered with 0.00 set as the default and any differently changed driving frequency is displayed once a user changes it.

### 5.4 How to move among codes in a group

● Moving between groups

Moving from 15 of PG Group to Drive Group

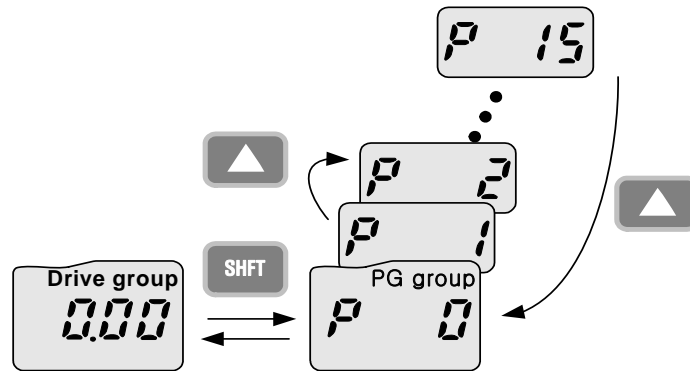

1		- . Display Code 15 of PG Group. - . Press SHFT key.
2		- . It displays F0, the first code of PG Group. - . Press SHFT key.
3		- . It displays 0.00, the first code of Drive Group.

● Code change in Drive Group

	1		- . It displays 0.00, the 1st code of Drive Group. - . Press UP(▲) key.
	2		- . It displays ACC, the 2nd code of Drive Group. - . Press UP(▲) key.
	3		- . It displays dEC, the 3rd code of Drive Group. - . Keep pressing UP(▲) key.
	4		- . It displays drC, the final code of Drive Group - . Press UP(▲) key in the final code of Drive Group.
	5		- . It returns to the 1st code of Drive Group.

Note

For moving reversely, use DOWN(▼) key.

● Code jump

Moving from code 1(P 0) to the code15(P15) in PG Group

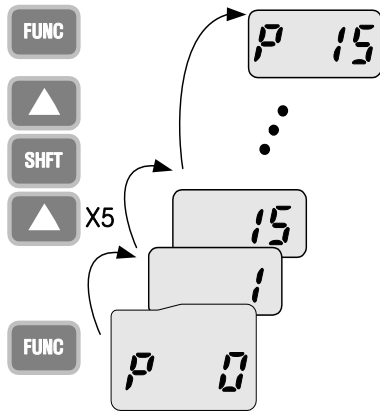

1		- It displays P0, the 1st code of Drive Group. - Press FUNC key.
2		- SET lamp lights up. Changeable number blinks - It shows moving to Code 1 is possible. Set 5 using UP(▲) key.
3		- The 1st digit is changed to 5. - Press SHFT key. - Blinking cursor moves and 05 is displayed. Change it to 1 using UP(▲) key.
4		- It shows moving to Code 15 is possible. - Pressing FUNC key enters 15.
5		- SET lamp is out. - It displays Code 15 of PG Group.

● Code change in PG Group

Moving from code 1 to code 15 in PG group

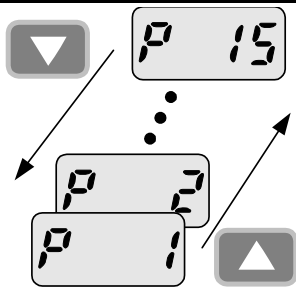

1		- It displays Code 1 of PG Group. - Keep pressing UP(▲) key until P 15 is displayed.
2		- It displays Code 15 of PG Group.

Note

Some codes will be skipped in the middle of increment (▲)/decrement (▼) for code change in PG Group. That is because it is programmed that some codes are intentionally reserved for later use or the codes user does not use are invisible. For details, refer to the table of functions in Chapter 7.

● Frequency setting

When changing RUN frequency to 30.05 [Hz] in Drive Group



1		- It displays Target Frequency, the 1st code of Drive Group. - Press FUNC key.
2		- SET lamp lights up. - The second decimal 0 becomes active. - Press the UP (▲) key until 5 is displayed.
3		- The second decimal is changed to 5. - Press SHFT key.
4		- The first decimal 0 becomes active. - Press SHFT key twice.
5		- The first digit 0 becomes active. - Set 3 using UP(▲) key.
6		- Press FUNC key.
7		- 30.05 blinks quickly and it asks whether to save the value. - Press FUNC key.
8		- SET lamp is out. - Blink stops and the saved target frequency are displayed.

**Note**  
Parameter setting is disabled when pressing other Keys except Function Key(FUNC) in step 6 where 30.05 blinks quickly.

5.5 How to set parameters

●Parameter change in Drive Group

Changing acceleration duration from 5.0 to 16.0 seconds

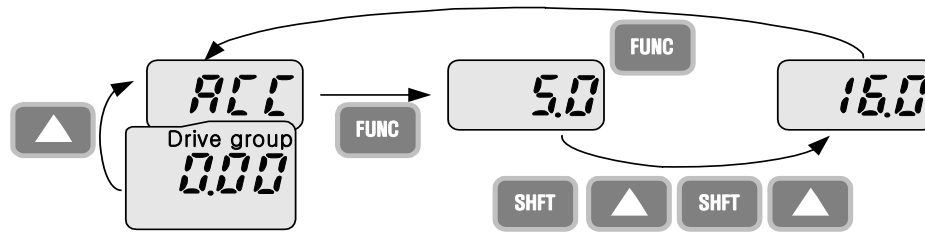

1		- It displays the target frequency, the 1st code of Drive Group. - Press UP(▲) key.
2		- It displays ACC, the acceleration duration, the 2nd code of Drive Group. - Press Function(FUNC) key.
3		- SET lamp lights up. - 0 in 5.0 blinks, which means that the digit may be changed. - Press Shift(SHFT) key.
4		- The digit to change is moved to the first digit. - Press UP(▲) key.
5		- The digit to change is increased, being changed to 6.0. - Press Shift(SHFT) key.
6		- The digit to change is moved the tenth digit. - Press UP(▲) key.
7		- It displays 16.0. - Press Function(FUNC) key. - 16.0 blinks wholly. <sup>1)</sup> - Press Function(FUNC) key. ACC duration of 16.0 seconds is entered.
8		- SET lamp is out - It displays ACC. ACC duration is changed to 16.0 seconds.

<sup>1)</sup> That every digit blinks quickly while modifying a parameter means asking whether to enter a modified value. At the moment, pressing Function(FUNC) key completes the entry. To cancel it instead of entering a parameter, press any key such as Shift(SHFT), UP(▲) or DOWN(▼) but Function(FUNC) key.

●Parameter change in PG Group

Changing P34, Code 34 of PG Group from 0 to 1

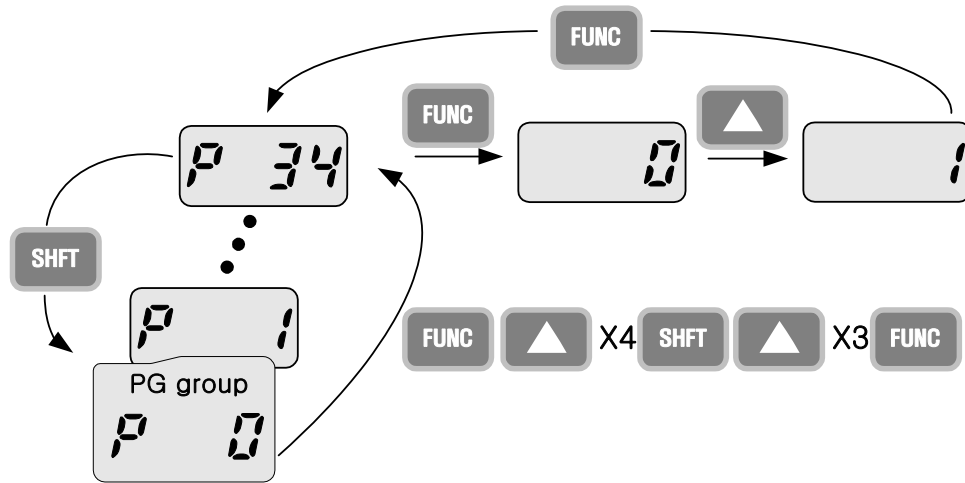

1		- The 1st code of PG Group is displayed. - Press FUNC key.
2		- SET lamp lights up. - Can move to Code 1. - Change it to 4 by using UP(▲) key.
3		- The first digit is changed to 4 - Press SHFT key.
4		- 0 in 04 is active. - Increase up to 3 by using UP(▲) key.
5		- Can move to Code 34 - Press FUNC key.
6		- SET lamp is out. - It means the current position is Code 34 of PG Group. - Press FUNC key.
7		- SET lamp light up. - Code 34 is set to 0. - Increase it to 1 by using UP(▲) key.
8		- Press FUNC key. - Press FUNC key once more when 1 blinks. - SET lamp is out.
9		- Function code change is complete. - Press SHFT key.
10		- Moved to Code 1 of PG Group.

5.6 Monitoring Operation Status

● Displaying Current Output

Monitoring output current in Drive Group

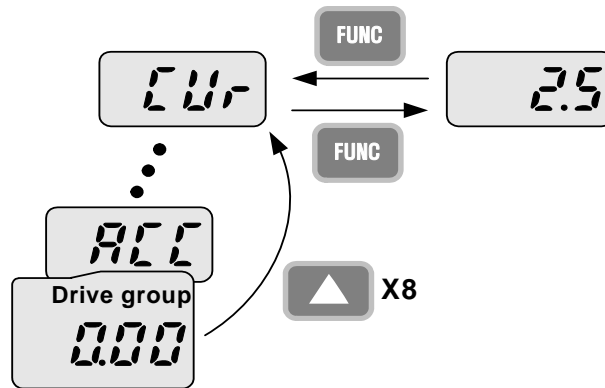

1		- The target frequency, Code 1 of Drive Group is displayed - Press UP(▲) key or DOWN(▼) key until Cur is displayed.
2		- Moved to a code to monitor output current. - Press FUNC key.
3		- Present output current is 2.5[A]. - Press FUNC key.
4		- Return to the output current monitoring code.

Note

Other parameters in Drive group such as dCL (Inverter DC link voltage) or vOL (Inverter output voltage) can be monitored via the same method.



● Fault display

How to monitor fault condition in Drive Group

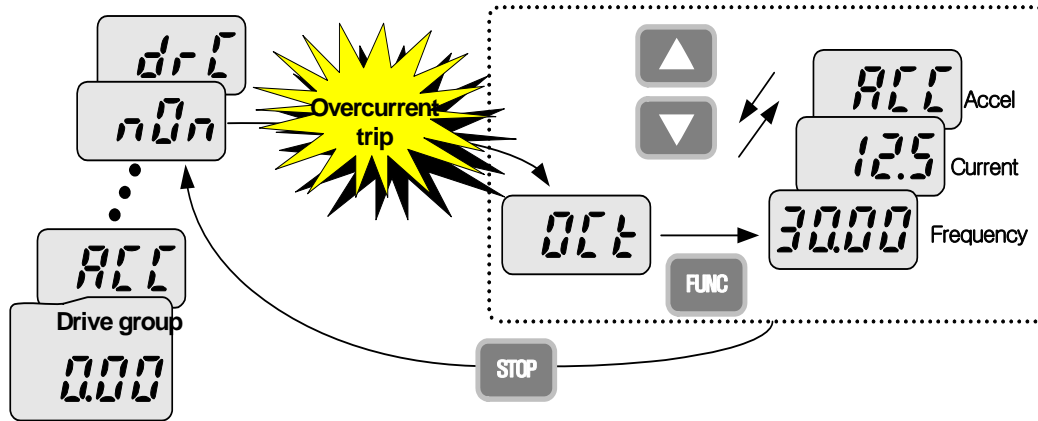

1		<ul style="list-style-type: none"> <li>- OCt appears when an Overcurrent fault occurs.</li> <li>- Press FUNC key.</li> <li>- Press UP(▲) key or DOWN (▼) key.</li> </ul>
2		<ul style="list-style-type: none"> <li>- The run frequency at the time of trip is displayed.</li> <li>- Press UP(▲) key.</li> </ul>
3		<ul style="list-style-type: none"> <li>- The output current at the time of trip is displayed</li> <li>- Press UP(▲) key.</li> </ul>
4		<ul style="list-style-type: none"> <li>- Operating status is displayed. A fault occurred during acceleration</li> <li>- Press STOP key.</li> </ul>
5		<ul style="list-style-type: none"> <li>- A fault condition is cleared and "nOn" is displayed.</li> </ul>

Note

Trip occurrence is displayed in one of modes like ACC, DEC, Stp or Std. Fault causes may be expected by using the indication.

- When types of faults occur at the same time

When Overcurrent(Oct), overvoltage(Ovt) and overheat(OHt) occur simultaneously

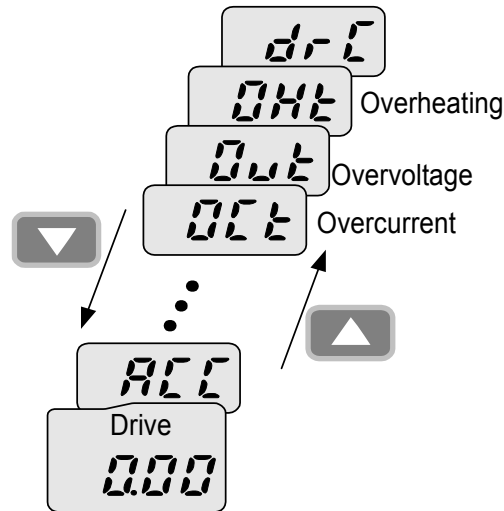

- When various trips occur simultaneously, it shows like the figure above and it can show up to 3 trips.

**Note**

In case inverter trip occurs, it shows the type in the current fault status indication code. In the case, if clearing it away by resetting or turning it off, fault info is moved to fault history(P 1) of PG Group. However, if any, the existing fault history moves from (P 1) to (P 2) or from (P 2) to (P 3); the latest fault info is saved in (P 1) through (P 3).

# MEMO

## 6. Basic Operation

### 6.1 Frequency Setting and Basic Operation

**Note**

The following parameters are set to factory defaults. Therefore, results may be different if any parameter is changed by a user. In this case, initialize parameters(see page 10-13) back to factory defaults and follow the instructions below.

- If setting frequency with the loader and commanding operation on the inverter's terminal

No.	Indication	Operation & description
1		- Target frequency, the first code of Drive Group when turning it on. - Press FUNC key.
2		- The second decimal, 0 in 0.00 displayed blinks. - Press SHFT three times.
3		- 00.00 is displayed and the very left 0 blinks. - Press UP(▲) key.
4		- Confirming 10.00, press FUNC key. - 10.00 blinks quickly as a whole. Press FUNC key once more.
5		- Target frequency is changed to 10.00Hz. - Turn on the switch between P1(FX) and CM terminals.
6		- FWD(forward run) lamp of the inverter display blinks and accelerating frequency is displayed on the LED. - When target run frequency 10Hz is reached, 10.00 is displayed. - Turn off the switch between P1 (FX) and CM terminals.
7		- FWD lamp begins to blink and decelerating frequency is displayed on the LED. - When run frequency is reached to 0Hz, RUN and FWD lamp turn off and target frequency (10.00) is displayed.

Wiring diagram	Operating pattern

## Chapter 6. Basic Operation

- If setting frequency with volume resistance on the loader and commanding operation on the inverter's terminal

No.	Indication	Operation & description
1		- Target frequency, the first code of Drive Group when turning it on. - Press UP(▲) key four times.
2		- Moved to a code to change a frequency setting mode. - Press FUNC key.
3		- The current frequency setting mode is set to 0(frequency setting using loader). - Press UP(▲) key two times.
4		- Check 3(frequency setting by loader's volume resistance). - Press FUNC key. - 3 blinks quickly. Press FUNC key once more.
5		- Frq is displayed and frequency setting mode is changed to loader volume. - Press SHFT moves to target frequency, the first code of Drive Group. - Turn the loader volume to MAX or MIN to set to 10.00Hz.
6		- Turn on the switch between P1 (FX) and CM. - FWD(forward run) lamp of the inverter display blinks and accelerating frequency is displayed on the LED. - When run frequency 10Hz is reached, the value is displayed as shown left. - Turn off the switch between P1 (FX) and CM terminals.
7		- FWD(forward run) lamp of the inverter display blinks and decelerating frequency is displayed on the LED. - When run frequency is reached to 0Hz, Run and FWD lamp turn off and target frequency(10.00)is displayed

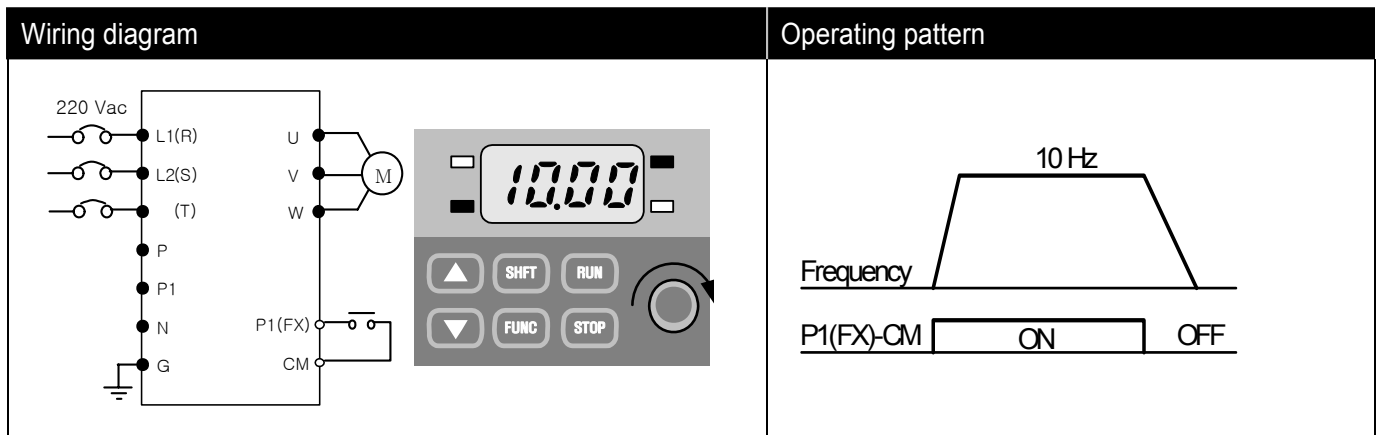

## Chapter 6. Basic Operation

● If setting frq with volume resistance on the loader and commanding operation with RUN key on the loader

No.	Indication	Operation & description
1		- Target frequency, the first code of Drive Group when turning it on. - Press UP(▲) key three times.
2		- Moved to a code to change a frequency setting mode - Press FUNC key.
3		- The current frequency setting mode is set to 1(terminal) - Press DOWN (▼) key.
4		- Operation command mode may be changed to 0(RUN key of the loader). - Press FUNC key twice.
5		- It displays drv and operation command mode is changed to RUN key. - Press UP(▲) key once.
6		- Moved to frequency setting mode(Frq) code. - Press FUNC key.
7		- Frequency setting mode is changed to 0(keypad of the loader). - Press UP(▲) key two times.
8		- Frequency setting mode may be changed to 3(loader's volume resistance). - Press FUNC key twice.
9		- It displays Frq and frequency setting mode is changed to loader volume. - Turn the loader volume to set to 10.00 in either Max or Min direction.
10		- Press RUN key. FWD(forward run) lamp of the inverter display blinks and accelerating frequency is displayed on the LED. - When run frequency 10Hz is reached, it is displayed as shown left. - Press STOP key.
11		- FWD(forward run) lamp of the inverter display blinks and decelerating frequency is displayed on the LED. - When run frequency 10Hz is reached, FWD(forward run) lamp is out and target frequency(10.00) is displayed on the LED.

Wiring diagram	Operating pattern

# MEMO

## 7. Function List

### ● Drive Group

Display	Name	Min/Max range	Description	Factory defaults	Adj. during run	Page		
0.0	Frequency command	0 ~ 200 [Hz]	This parameter sets the operation frequency. During stop, it displays Frequency Command; During run, it shows output frequency. During multi-step operation, it becomes frequency 0. It cannot be set greater than Max frequency(P16).	0.00	O	9-1		
ACC	Acc time	0 ~ 6000	During multi-acc/dec operation, this parameter serves as acc/dec time 0.	5.0	O	9-8		
dEC	Dec time	[sec]		10.0	O	9-8		
drv	Drive mode	0 ~ 3	0	Operate with RUN/STOP key of the loader	1	X	9-5	
			1	Terminal operation			FX: forward run RX: reverse run	9-6
			2				FX: Run/stop command RX: Reverse rotation	
			3	communication: communication option				
Frq	Frequency setting method	0 ~ 4	0	Digital	0	X	9-1	
			1				Set loader digital frequency 2	9-1
			2	Analogue			Terminal AI input	9-3
			3				Loader volume resistance	9-2
			4				communication option	
St1	Multi-step frequency 1	0 ~ 200 [Hz]	Set multi-step frequency 1	10.00	O	9-4		
St2	Multi-step frequency 2		Set multi-step frequency 2	20.00	O			
St3	Multi-step frequency 3		Set multi-step frequency 3	30.00	O			



● Drive Group

Display	Name	Min/Max range	Description	Factory defaults	Adj. during run	Page	
CUr	Output current	-	Display output current	-	-	11-1	
rPM	No. of motor rotation	-	Display the no. of motor rotation(RPM)	-	-	11-1	
dCL	Inverter DC voltage	-	Display DC voltage inside the inverter	-	-	11-1	
vOL	Output voltage	-	Display the inverter's output voltage.	vOL	-	11-2	
nOn	Fault display	-	Display the types of fault, frequency, current and operation status.	-	-	11-4	
drC	Selection of motor rotation direction	F, r	If operation command mode(drv) is set to 0, select the direction of motor rotation	P	O	9-7	
			F				Forward operation
			r				Reverse operation

●PG Group

Display	Name	Min/Max range	Description		Factory defaults	Adj. during run	Page
P 0	Jump code	0 ~ 88	Sets the code number to jump		1	O	5-5
P 1	Fault log 1	-	It logs the information on the types of faults, and the frequency, current and status such as acceleration, deceleration and stop at the time of trouble. The latest fault is automatically recorded in log 1.		nOn	-	11-4
P 2	Fault log 2	-			nOn	-	
P 3	Fault log 3	-			nOn	-	
P 4	Fault log removal	0 ~ 1	Remove log P1~P3.		0	O	
P 5	Prohibition of forward/reverse rotation	0 ~ 2	0	Both F/R directions available	0	X	9-7
			1	Forward rotation prohibited			
			2	Reverse rotation prohibited			
P 6	Acc pattern	0 ~ 1	0	Linear pattern operation	0	X	9-9
P 7	Dec pattern		1	S-curve pattern operation			
P 8	Stop mode selection	0 ~ 2	0	Deceleration to stop	0	X	9-14
			1	DC brake to stop			
			2	Free run to stop			
P 9 <sup>1)</sup>	DC brake start frequency	0.1 ~ 60 [Hz]	It sets DC brake start frequency. It cannot be set below start frequency(P18).		5.00	X	10-1
P10	DC brake wait time	0 ~ 60 [sec]	When DC brake frequency is reached, the inverter holds the output for the setting time before starting DC brake.		0.10	X	
P11	DC brake voltage amount	0 ~ 200 [%]	It sets the amount of DC voltage applied to a motor. Motor rated current(P43).		50	X	
P12	DC brake time	0 ~ 60 [sec]	It sets the time taken to apply DC current to a motor.		1.0	X	

<sup>1)</sup> Displayed only when P8 is set to 1(DC brake to stop)

●PG Group

Display	Name	Min/Max range	Description	Factory defaults	Adj. during run	Page
P13	DC brake start voltage	0 ~ 200 [%]	It sets the amount of DC voltage before a motor starts to run. Motor rated current(P43)	50	X	10-2
P14	DC brake start time	0 ~ 60 [sec]	It applies the current to a motor for the set time before motor accelerates.	0.0	X	
P15	Jog frequency	0 ~ 200 [Hz]	It sets the frequency for jog operation. It can not be set above the max frequency(P16).	10.00	O	10-3
P16	Max frequency	40 ~ 200 [Hz]	<p>This parameter sets the upper limit frequency. It is frequency reference for Accel./Decel.</p> <p><b>Note</b></p> <p>If changing the max frequency, all other frequency parameters but P17(base frequency) would be changed to the frequency if they are above the new max. frequency.</p>	60.00	X	9-8
P17	Base frequency	30 ~ 200 [Hz]	The inverter outputs its rated voltage to the motor at this frequency.	60.00	X	9-11
P18	Start frequency	0.1 ~ 10 [Hz]	The inverter starts to output its voltage at this frequency. It is lower frequency limit of frequency(Hz).	0.5	X	
P19	Torque boost selection	0 ~ 1	0    Manual torque boost	0	X	9-13
			1    Auto torque boost			
P20	Forward torque boost	0 ~ 15 [%]	Torque boost amount of motor during forward run, based on max. output voltage.	5.0	X	
P21	Reverse torque boost		Torque boost amount of motor during reverse run based on max. output voltage.			
P22	V/F pattern	0 ~ 1	0    Linear	0	X	9-11
			1    Square			9-12

## Chapter 7. Function List

### ●PG Group

Display	Name	Min/Max range	Description	Factory defaults	Adj. during run	Page			
P23	Output voltage adjustment	40 ~ 110 [%]	It adjusts the amount of output voltage, based on the percentage of input voltage.	100	X	9-12			
P24	Overload trip selection	0 ~ 1	This parameter turns off the inverter output when motor is overloaded. Overload protection function works if it is set to 1.	1	0	12-1			
P25 <sup>1)</sup>	Overload trip level	50 ~ 200 [%]	It sets the amount of overload current, based on the percentage of Motor rated current(P43)	180	0	12-1			
P26	Overload trip time	0 ~ 60 [sec]	It turns off the inverter output when overload trip level current(P25) flows for overload trip time.	60	0				
P27	Stall prevention select	0 ~ 7	Sets stall prevention function				0	X	12-1
			Func.	During dec.	During constant run	During acc.			
			Set	bit 2	bit 1	bit 0			
			0	-	-	-			
			1	-	-	✓			
			2	-	✓	-			
			3	-	✓	✓			
			4	✓	-	-			
			5	✓	-	✓			
6	✓	✓	-						
7	✓	✓	✓						
P28	Stall prevention level	30 ~ 150 [%]	It sets the amount of current to activate stall prevention function, based on the percentage of the motor rated current(P43).	150	X	12-1			
P29	Save up/down frequency	0 ~ 1	It decides whether to save the specified frequency during up/down operation. If 1 is selected, the up/down frequency is saved in P30.	0	X	10-4			
P30 <sup>2)</sup>	Save Up/Down	-	It saves the frequency before the inverter stops or decelerated.	0.00	-	10-4			

<sup>1),2)</sup> Set P24 and P29 to 1 to display this parameter.

●PG Group

Display	Name	Min/Max range	Description	Factory defaults	Adj. during run	Page																																								
P31	Dwell frequency	0.1 ~ 200 [Hz]	When run frequency is issued, motor starts to accelerate after dwell frequency is applied to the motor during dwell time(P32). It can be set within max frequency(P16) and start frequency(P18).	5.00	X	10-5																																								
P32	Dwell time	0~10 [sec]	Sets the time for dwell operation.	0.0	X																																									
P33	Operator's fault detection	0 ~ 7 [bit]	Sets fault detection items at operator's discretion	0	O	12-2																																								
			<table border="1"> <thead> <tr> <th>Func. Set</th> <th>Earth detection during run(GCt)</th> <th>Input phase detection (CoL)</th> <th>Output phase detection (Pot)</th> </tr> <tr> <th></th> <th>bit2</th> <th>bit1</th> <th>bit0</th> </tr> </thead> <tbody> <tr> <td>0</td> <td>-</td> <td>-</td> <td>-</td> </tr> <tr> <td>1</td> <td></td> <td></td> <td>✓</td> </tr> <tr> <td>2</td> <td></td> <td>✓</td> <td></td> </tr> <tr> <td>3</td> <td></td> <td>✓</td> <td>✓</td> </tr> <tr> <td>4</td> <td>✓</td> <td></td> <td></td> </tr> <tr> <td>5</td> <td>✓</td> <td></td> <td>✓</td> </tr> <tr> <td>6</td> <td>✓</td> <td>✓</td> <td></td> </tr> <tr> <td>7</td> <td>✓</td> <td>✓</td> <td>✓</td> </tr> </tbody> </table>				Func. Set	Earth detection during run(GCt)	Input phase detection (CoL)	Output phase detection (Pot)		bit2	bit1	bit0	0	-	-	-	1			✓	2		✓		3		✓	✓	4	✓			5	✓		✓	6	✓	✓		7	✓	✓	✓
			Func. Set				Earth detection during run(GCt)	Input phase detection (CoL)	Output phase detection (Pot)																																					
							bit2	bit1	bit0																																					
			0				-	-	-																																					
			1						✓																																					
			2					✓																																						
			3					✓	✓																																					
			4				✓																																							
			5				✓		✓																																					
6	✓	✓																																												
7	✓	✓	✓																																											
P34	Power On Start Selection	0 ~ 1	It is activated when drv is set to 1 or 2. Motor starts acceleration after AC power is applied while FX or RX terminal is ON.	0	X	9-7																																								
P35	Restart after fault reset selection	0 ~ 1	It is activated when drv is set to 1 or 2 (Run/Stop via Control terminal). Motor accelerates after the fault condition is reset while the FX or RX terminal is ON.	0	O	9-8																																								

Chapter 7. Function List

●PG Group

Display	Name	Min/Max range	Description	Factory defaults	Adj. during run	Page				
P36	Speed search selection	0 ~ 15 [bit]	It is active to prevent any possible fault when the inverter outputs its voltage to the running motor.	0	X	10-10				
			Func.				Power on start (P34)	Restart after instant power failure	Operation on after fault (P35)	Normal acc.
			Set				bit3	bit2	bit1	bit0
			0				-	-	-	-
			1				-	-	-	✓
			2				-	-	✓	
			3				-	-	✓	✓
			4				-	✓	-	-
			5				-	✓	-	✓
			6				-	✓	✓	-
			7				-	✓	✓	✓
			8				✓	-	-	-
			9				✓	-	-	✓
			10				✓	-	✓	-
			11				✓	-	✓	✓
			12				✓	✓	-	-
			13				✓	✓	-	✓
14	✓	✓	✓	-						
15	✓	✓	✓	✓						
P37	Speed Search Current Level		Limits the amount of current during speed search operation, based on motor rated current(P43)	100	0					

●PG Group

Display	Name	Min/Max range	Description	Factory defaults	Adj. during run	Page
P38	Number of Auto Restart try	0 ~ 10	It sets the number of restart tries after a fault occurs. Auto Restart is deactivated if the fault outnumbers the restart tries. This function is active when [drv] is set to 1 or 2 {Run/Stop via control terminal}.	0 <sup>1)</sup>	O	10-12
P39	Auto Restart time	0 ~ 60 [sec]	Restart tries after auto restart waiting time has passed.	1.0	O	
P40	Motor cap. select	0.1~ 0.4 [kW]	Selects the capacity of a motor to use.	2)	X	10-6
P41	Number of motor poles	2 ~ 12	It is displayed via rpm in drive group.	4	X	
P42	Rated slip frequency	0 ~ 10 [Hz]	Enter the difference between the input power frequency and the value calculated by converting rpm described in the nameplate to frequency.	3)	X	
P43	Motor rated current	0.0~ 25.5 [A]	Enter motor rated current on the nameplate.	-	X	
P44	No Load Motor Current	0.0 ~ 25.5 [A]	Enter the current value detected when the motor is rotating in rated rpm after the load connected to the motor shaft is removed. Enter the 50% of the rated current value when it is difficult to measure No Load Motor Current.	-	X	
P45	Carrier frequency select	1 ~ 10 [kHz]	It selects the audible sound of the motor. If the set value is higher, the inverter sound is quieter but the noise from the inverter and leakage current will become greater.	3	O	10-13

<sup>1)</sup> No auto restart in case of protection functions such as Oht, Lvt, ESt, HWt.

<sup>2)</sup> P40 initial value is preset based on inverter rating.

<sup>3)</sup> P42 ~ P44 values are changed based on the P40. factory defaults are set based on the inverter capacity.

●PG Group

Display	Name	Min/Max range	Description	Factory defaults	Adj. during run	Page	
P46	Control mode selection	0 ~ 2	0	V/F control	0	X	9-11
			1	Slip compensation control			10-6
			2	PI control			10-8
P47 <sup>1)</sup>	P gain for PI controller	0~ 999.9 [%]	It sets the gains for the PI controller's response characteristics.	300.00	O		
P48	I time for PI controller	0.1~32.0 [sec]		1.00	O		
P50	F gain for PI controller	0 ~ 99.99 [%]		Feed forward gain for PI controller.	0.00		O
P51	Upper limit of PI frequency	0.1 ~ 200 [Hz]	It limits the amount of the output frequency through the PI operation.	60.00	O		
P52	Lower limit of PI frequency	0.1 ~ 200 [Hz]	It is settable within the range of Max frequency(P16) and Start frequency(P18).	0.50	O		
P53	Power on display	0 ~ 15		It selects the parameter to be displayed first on the display of inverter when the power is applied.	0	O	11-2
			0	Operation frequency			
			1	Acc. time			
			2	Dec. time			
			3	Drive mode			
			4	Frequency mode			
			5	Multi-step frequency 1			
			6	Multi-step frequency 2			
			7	Multi-step frequency 3			
			8	Output current(Cur)			
			9	Motor rpm			
			10	Inverter DC voltage(DCL)			
			11	User display select(vOL)			
			12	Fault display 1			
			13	Direction of motor rotation			
14	Output current						
15	Motor rpm						

Displayed only when P46 is set to 2(PI control).



●PG Group

Display	Name	Min/Max range	Description	Factory defaults	Adj. during run	Page
P54	Gain for Motor rpm display	1 ~ 1000 [%]	It can monitoring on the rpm display code of drive group as converting gear ratio of load system.	100	O	11-1
P55	Filter time constant for AI input	0 ~ 9999	Adjusts the responsiveness of analogue input.	10	O	9-3
P56	Min input for AI(vol/cur)	0 ~ 100 [%]	Sets the min value of analogue input as the percentage of the whole input.	0	O	
P57	Frequency corresponding min input for AI	0 ~ 200 [Hz]	Frequency in case analogue input is the min value.	0.00	O	
P58	AI max input	0 ~ 100 [%]	Sets the max value of analogue input as the percentage of the whole input.	100	O	
P59	Frequency corresponding to AI max input	0 ~ 200 [Hz]	Frequency in case analogue input is the max. value.	60.00	O	
P60	Filter time constant for Volume input	0 ~ 9999	Adjusts the responsiveness of volume input operation.	10	O	9-2
P61	Min value for volume input	0 ~ 100 [%]	Sets the min rpm of volume input as the percentage of the whole input	0	O	
P62	Frequency corresponding to volume input	0 ~ 200 [Hz]	Frequency at minimum current of volume input	0.00	O	
P63	Max. value of volume input	0 ~ 100 [%]	Sets the max volume input as the percentage of the whole input.	100	O	
P64	Frequency corresponding to volume input	0 ~ 200 [Hz]	Frequency at maximum volume input.	60.00	O	
P65	Criteria for Analog Input Signal loss	0 ~ 2	0: Disabled 1: activated below half of set value. 2: activated below set value.	0	O	12-4

●PG Group

Display	Name	Min/Max range	Description					Factory defaults	Adj. during run	Page		
P66	Multi-function input terminal P1 define	0 ~ 24	0	Forward run command (FX)					0	O	9-6	
			1	Reverse run command (RX)								
P67	Multi-function input terminal P2 define		2	EST-Emergency Stop Trip : temporary output cut-off					1	O	-	
P68	Multi-function input terminal P3 define		3	Reset when a fault occurs(RST)					2	O	-	
			4	Jog operation command (JOG)							10-3	
P69	Multi-function input terminal P4 define		5	Multi-Step freq – low					3	O	9-5	
			6	Multi-Step freq – high								
P70	Multi-function input terminal P5 define		7	-					4	O	-	
			8	-							-	
			9	-							-	
			10	-							-	
			11	DC brake during stop							10-1	
			12	-							-	
			13	-							-	
			14	-							-	
			15	Up-	Frequency up						10-4	
			16	down	Frequency down							
			17	3-wire operation							10-4	
			18	External trip: A Contact (EtA)							12-5	
			19	External trip: B Contact (EtB)								
			20	Change from PI operation to general operation							-	
21	-					-						
22	Analog Hold					9-4						
23	Accel/Decel Disable					9-10						
24	Up/Down Save Freq. Initialization					10-4						
P71	Input terminal status display	BIT4	BIT3	BIT2	BIT1	BIT0	-	-	11-3			
		P5	P4	P3	P2	P1						

●PG Group

Display	Name	Min/Max range	Description		Factory defaults	Adj. during run	Page	
P72	Filtering time constant for Multi-function Input terminal	1 ~ 20	If the value is set higher, the responsiveness of the Input terminal is getting slower.		3	0	-	
P73	Analog output item select	0 ~ 3		Output item	Output to 10[V]	0	0	11-5
			0	Output freq.	Max frequency			
			1	Output current	150 %			
			2	Output voltage	282 V			
			3	Inverter DC link voltage	DC 400V			
P74	Analog output level adjustment	10 ~ 200 [%]	Based on 10V.		100	0		
P75	Frequency detection level	0 ~ 200 [Hz]	Used when P77 is set to 0-4. Cannot be set higher than P16.		30.00	0	11-7	
P76	Frequency detection bandwidth				10.00	0	11-9	
P77	Multi-function relay select	0 ~ 17	0	FDT-1	17	0	11-7	
			1	FDT-2				
			2	FDT-3			11-8	
			3	FDT-4				
			4	FDT-5			11-9	
			5	-				
			6	Inverter Overload (IOLt)				
			7	Motor stall (STALL)				
			8	Over voltage trip (OVt)				
			9	Low voltage trip (LVt)				
			10	Inverter cooling pin Overheat (OHT)				
			11	Command loss			11-10	
			12	During Run				
			13	During Stop				
			14	During constant run				
			15	During speed searching				
			16	Wait time for run signal input				
17	Fault output select							

●PG Group

Display	Name	Min/Max range	Description				Factory defaults	Adj. during run	Page
P78	Fault output select	0 ~ 7 [bit]	Func.	Operation when setting the number of auto restart try(P38)	Operation when the trip other than low voltage trip occurs	Operation when the low voltage trip occurs	2	0	11-10
			Set	bit 2	bit 1	bit 0			
			0	-	-	-			
			1	-	-	✓			
			2	-	✓	-			
			3	-	✓	✓			
			4	✓	-	-			
			5	✓	-	✓			
			6	✓	✓	-			
			7	✓	✓	✓			
P79	Inverter number	1 ~ 250	Set for RS-485 communication				1	0	14-3
P80	Baud rate	0 ~ 2	Select the Baud rate of the RS-485.				2	0	14-3
			0	2400 [bps]					
			1	4800 [bps]					
			2	9600 [bps]					
P81	Drive mode select after loss of frequency command	0 ~ 2	It is used when freq command is given via Analog signal(volume/AI) or RS-485.				0	0	12-4
			0	Continuous operation at the frequency before its command is lost.					
			1	Free Run stop (Output cut-off)					
			2	Decel to stop					
P82	Wait time after loss of frequency command	0.1 ~ 120 [sec]	Time inverter determines whether there is the input frequency command or not. If there is no frequency command input during this time, inverter starts operation via the mode selected at P81.				1.0	0	
P83	Communication time setting	2 ~ 100 [ms]	When RS-485 communication, waiting time from TX to the next TX.				5	0	

●PG Group

Display	Name	Min/Max range	Description	Factory defaults	Adj. during run	Page		
P84	Parity/stop bit setting	0 ~ 3	Sets communication parity and stop bit.		0	O		
				Parity bit				Stop bit
			0	-				1 Stop Bit
			1	-				2 Stop Bit
			2	Odd Parity				1 Stop Bit
			3	Even Parity				1 Stop Bit
P85	Parameter initialization	0 ~ 3	Initialize the parameters set by a user to factory defaults		0	X	10-13	
			0	-				
			1	Initialize both groups				
			2	Initialize Drive Group				
			3	Initialize PG Group				
P86	Password registration	0 ~ FFFF	Enter password to prohibit parameter change. Set it as hexadecimal number		0	O	10-14	
P87	parameter change prohibition	0 ~ FFFF	Prohibit or cancel parameter change prohibition by using the password set in P86.		0	O	10-15	
			UL(Unlock)	Enable parameter change				
			L(Lock)	Disable parameter change				
P88	Software version	-	Display inverter software version. Refer to manual version.		-	X		

## 8. Control Block Diagram

### 8.1 Control Flow

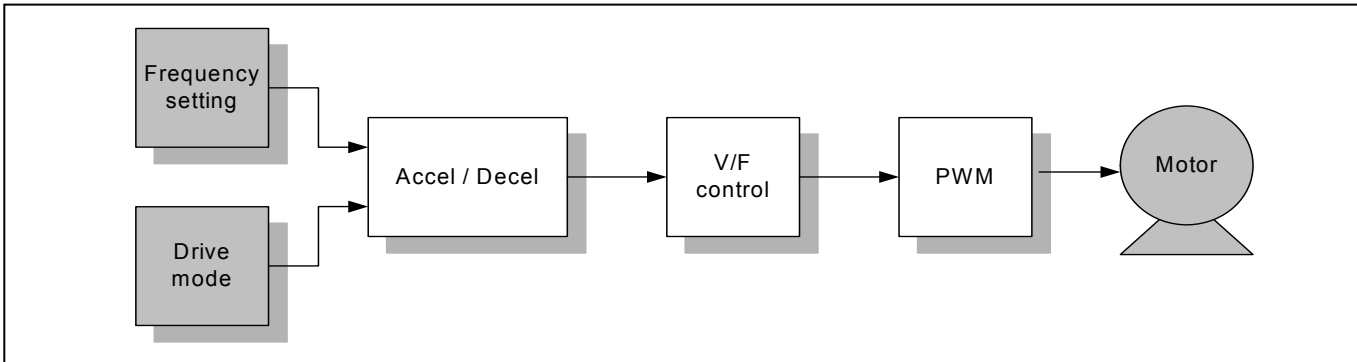

### 8.2 Frequency Setting & Drive Mode Setting

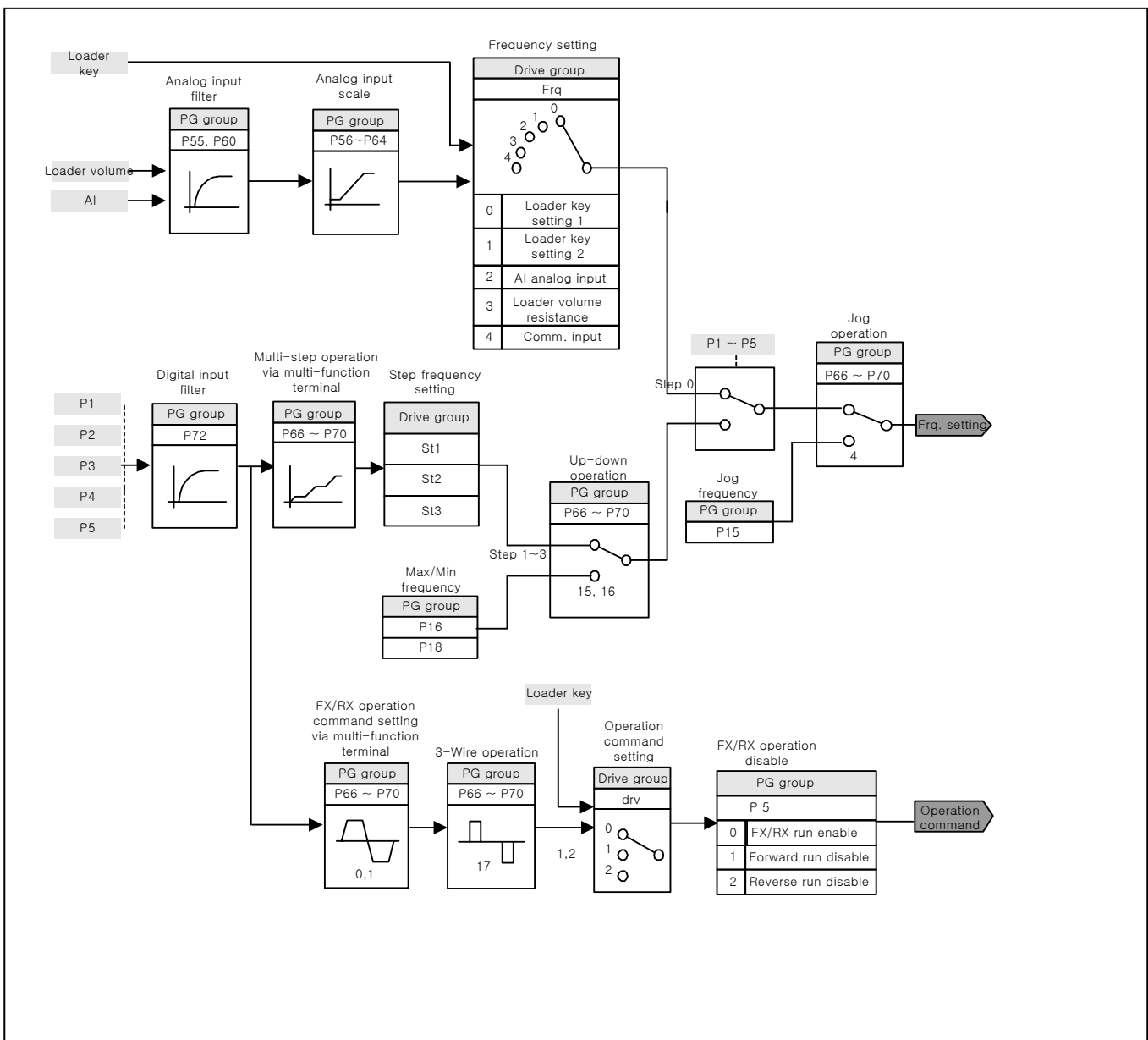

8.3 Frequency Setting, Drive Acc./Dec. Setting and V/F Voltage Control

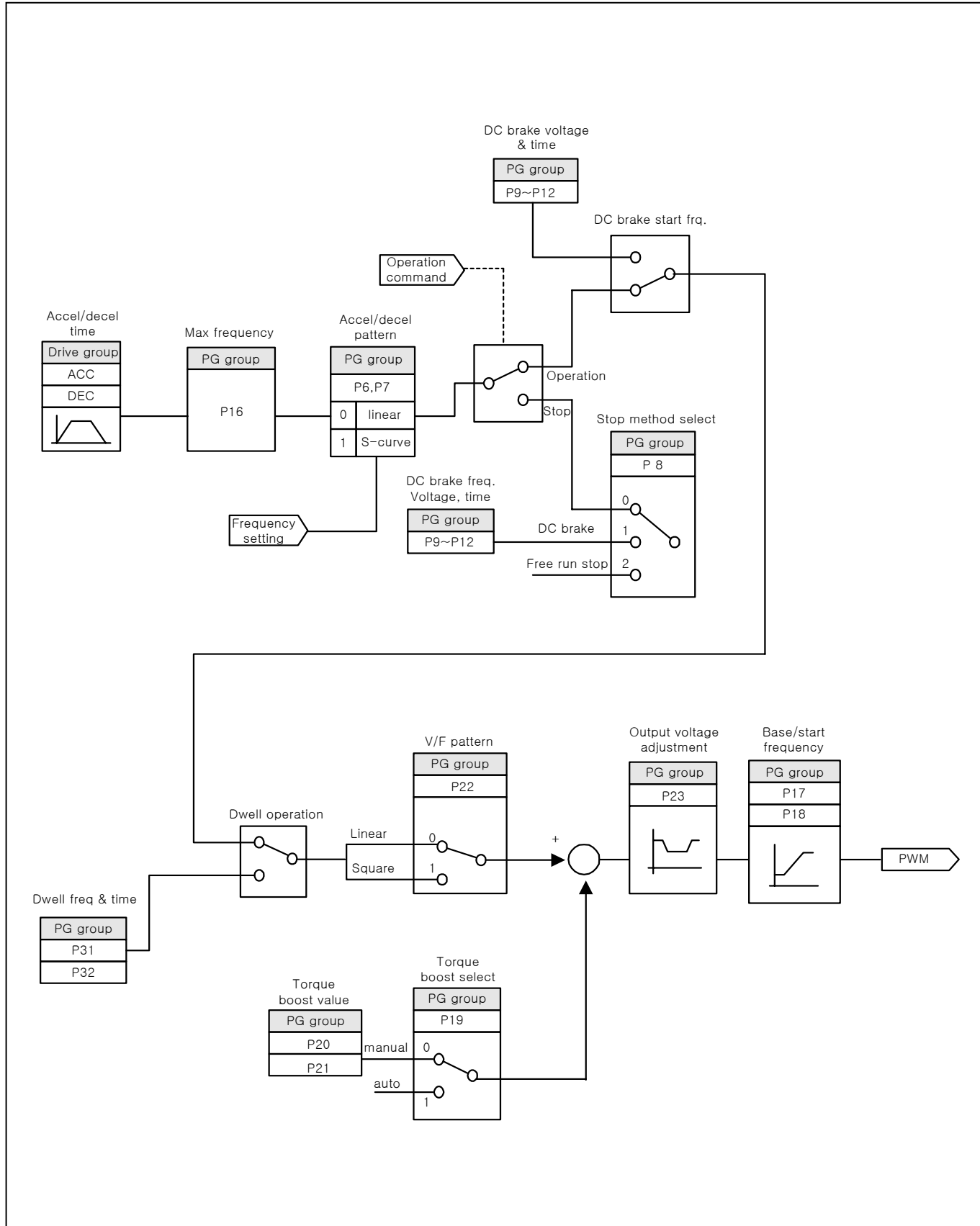

## 9. Basic Functions

### 9.1 Frequency Setting

● Loader Digital Frequency Setting1

Group	Code	Parameter Name	Setting	Range	Initial	Unit
Drive Group	0.00	Frequency command	-	0 ~ 200	0.0	Hz
	Frq	Frequency mode	0	0 ~ 4	0	

- Set Frq – [Frequency mode] to 0.
- Set the desired frequency in 0.00 and press FUNC key to enter the value into memory.
- The value is settable less than the max. frequency(P16).

● Loader Digital Frequency Setting2

Group	Code	Parameter Name	Setting	Range	Initial	Unit
Drive Group	0.00	Frequency command	-	0 ~ 200	0.0	Hz
	Frq	Frequency mode	1	0 ~ 4	0	

- Set Frq – [Frequency mode] to 1.
- In 0.00, frequency is changed upon pressing the Up (▲)/Down (▼) key. In this case, UP/Down keys serve as volume resistance.
- The value is settable less than the max. frequency(P16).

● Using Loader's volume resistance(run in case of Frq: 3)

- ▶ SV-iE5 series basically offer volume resistance on the inverter's loader for frequency command. Through this volume resistance, it supplies 0~5 V and enables frequency setting. At the moment, voltage input is indicated as input value.
- ▶ Loader volume is getting larger as it rotates clockwise.

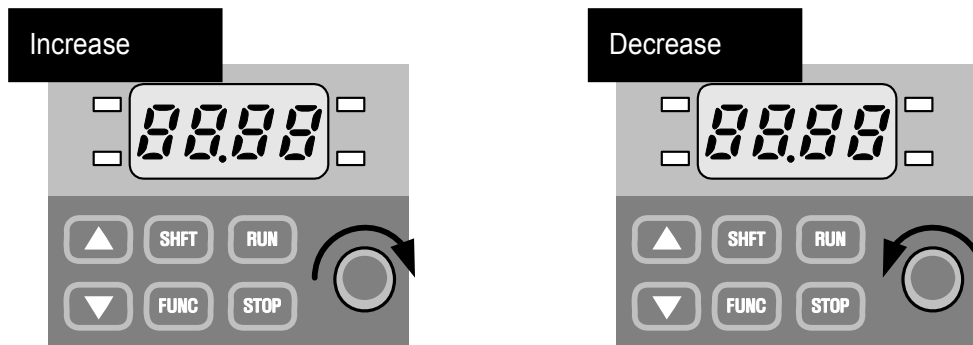



● Frequency setting with the loader's volume resistance(V0)

Group	Code	Parameter Name	Setting	Range	Initial	Unit
Drive Group	0.0	Frequency Command	-	-	-	Hz
	Frq	Frequency setting mode	3	0 ~ 4	0	
PG Group	P60	Filter time constant for V0 input	10	0 ~ 9999	10	
	P61	V0 input Min voltage	-	0 ~ 100	0	%
	P62	Frequency corresponding to P61	-	0 ~ 200	0.00	Hz
	P63	V0 input max voltage	-	0 ~ 100	100	%
	P64	Frequency corresponding to P63	-	0 ~ 200	60.00	Hz

- Select 3 in Frq code of Drive group
- It is possible to monitor frequency setting in Command Frequency Code(0.0) of Drive Group.

- ▶ P60(Filter time constant for V0 input): Effective for eliminating noise in the frequency setting circuit. Increase the filter time constant if steady operation cannot be performed due to noise. A larger setting results in slower response (t gets longer).

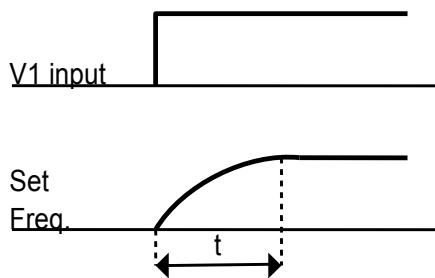

- ▶ P61 ~ P64: Setting input range and corresponding frequency to -10V ~ 0V V1 input voltage.
- ▶ When minimum input voltage is 20% with corresponding frequency 10Hz and Max voltage is 80% with run freq. 50Hz, set as follow.

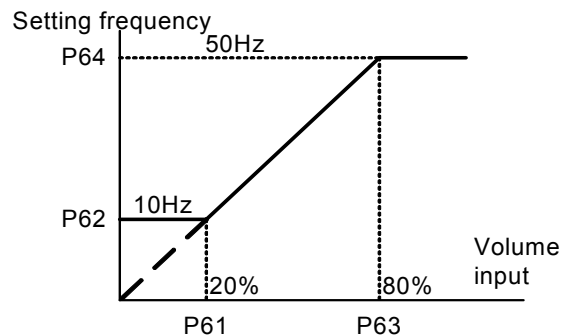

● Frequency setting using AI(analogue input) terminal

Group	Code	Parameter Name	Setting	Range	Initial	Unit
Drive Group	0.0	Frequency Command	-	-	-	Hz
	Frq	Frequency setting mode	2	0 ~ 4	0	
PG Group	P55	Input filter time constant for AI	10	0 ~ 9999	10	
	P56	Min. input for AI(V/I)	-	0 ~ 100	0	%
	P57	Frequency corresponding to P56	-	0 ~ 200	0.00	Hz
	P58	Max. input for AI (V/I)	-	0 ~ 100	100	%
	P59	Frequency corresponding to P58	-	0 ~ 200	60.00	Hz

- Select 2 in Frq code of Drive group.
  - It is possible to use by inputting 0 ~ 10V in an external control or connecting variable resistance to VR,AI,CM terminals of the inverter.
- ▶ Inverter terminal may be wired as follows and see page 9-2 for the functions of P55 through P59.
- ▶ Depending on AI selection switch beside the inverter's control terminal as V, I, it is possible to select one of voltage input and current input.

## Caution

For AI selection, set it accurately according to the current input and voltage input. Incorrect setting may cause the inverter troubled.

In the below, switch direction is colored in black.

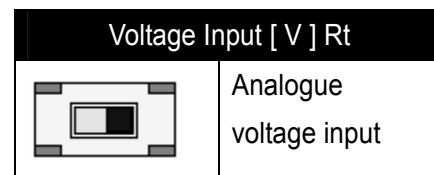
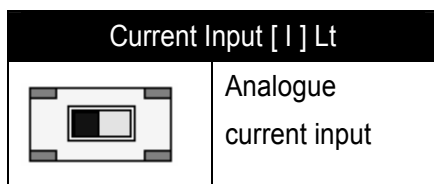

1) Using CI

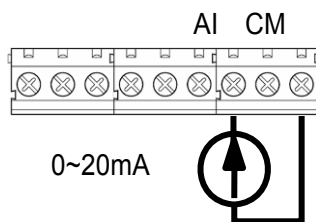

2) Using Ex. voltage

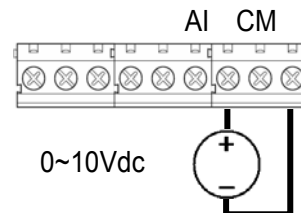

3) Using V.R

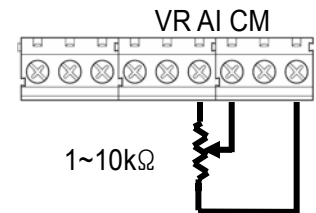

● Analogue frequency command fixed

Group	Code	Parameter Name	Setting	Range	Initial	Unit
Drive Group	Frq	Frequency setting mode	2 ~ 3	0 ~ 4	0	
PG Group	P66	Multi-function input terminal P1 select	-	0 ~ 24	0	
	~	~				
	P70	Multi-function input terminal P5 select	22		4	

- If Frq code of Drive Group is 2~3, it works.
- Select a terminal to use as analogue frequency command fixed signal among multi-function input terminals(P1 ~ P5).

▶ It works as shown in the below figure if using P5 terminal.

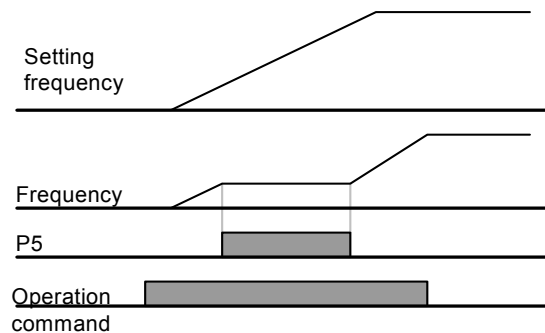

9.2 Multi-Step Frequency Setting

Group	Code	Parameter Name	Setting	Range	Initial	Unit
Drive Group	0.0	Frequency command	5.0	0 ~ 200	0.0	Hz
	Frq	Frequency setting mode	0	0 ~ 4	0	-
	St1	Multi-step freq.1	-	0 ~ 200	10.0	Hz
	St2	Multi-step freq.2	-		20.0	
	St3	Multi-step freq.3	-		30.0	
PG Group	P68	Multi-function input terminal P3 define	5	0 ~ 24	2	-
	P69	Multi-function input terminal P4 define	6		3	-

- Select a terminal to give Multi-step frequency command among P1-P5 terminals.
- If terminals P3-P4 are selected, set P68-79 to 5 - 6 to give Multi-step frequency command.
- Multi-step frequency 0 is settable in [Frequency mode] and [Frequency command(0.0)].
- Multi-step frequency 1-3 are set at St1-St3 in Drive group.

- ▶ If running by using multi-step high/low, it is possible to run from 0 to 3 step in 4 combinations as the below figure.

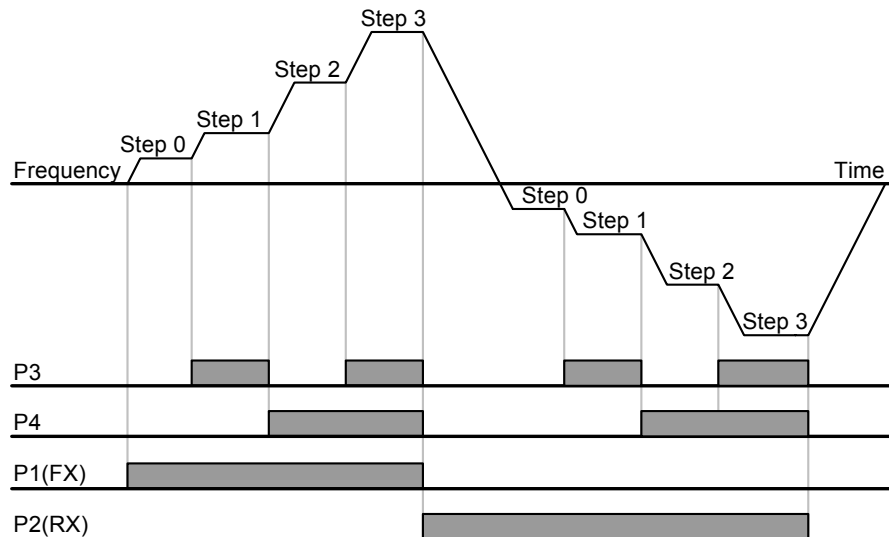

Speed	FX/ RX	P4	P3
0	✓	-	-
1	✓	-	✓
2	✓	✓	-
3	✓	✓	✓

### 9.3 Operating command setting method

- Operation by RUN key and STOP/RST key of the loader

Group	Code	Parameter Name	Setting	Range	Initial	Unit
Drive Group	drv	Drive mode	0	0 ~ 3	1	
	drC	Motor rotation direction select	-	F, r	F	

- Set drive code of Drive Group to 0.
- Acceleration is started upon pressing the Run key while operating frequency is set. Motor decelerates to stop by pressing the STOP/RST key.
- Selecting rotation direction is available at drC - [Direction of motor rotation select] when operating command is set to 0.

drC	Direction of motor rotation select.	F	Forward
		r	Reverse

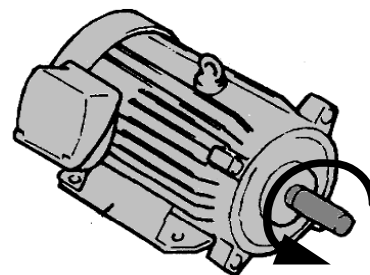

FX : counter clockwise

● Operating command via FX, RX terminal

Group	Code	Parameter Name	Setting	Range	Initial	Unit
Drive Group	drv	Drive mode	1	0 ~ 3	1	
PG Group	P66	Multi-function input terminal P1 define	0	0 ~ 24	0	
	P67	Multi-function input terminal P2 define	1	0 ~ 24	1	

- Set drv code of Drive Group to 1.
- Set P66 and P67 to 0 and 1 to use P1 and P2 as FX and RX terminals.
- FX is forward run command and RX is reverse run command.
  - ▶ Motor is stopped when FX/RX terminal is ON/OFF at the same time.

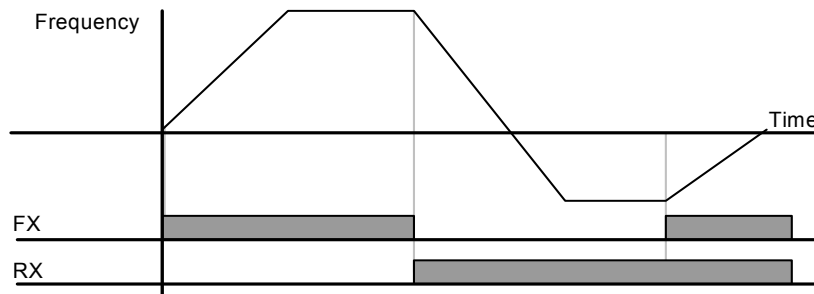

● Operating command via FX, RX terminal 2

Group	Code	Parameter Name	Setting	Range	Initial	Unit
Drive Group	drv	Drive mode	2	0 ~ 3	1	
PG Group	P66	Multi-function input terminal P1 define	0	0 ~ 24	0	
	P67	Multi-function input terminal P2 define	1	0 ~ 24	1	

- Set drv code of Drive Group to 2.
- Set P66 and P67 to 0 and 1 to use P1 and P2 as FX and RX terminals.
- FX: Operating command setting. Motor runs in forward direction when RX terminal is OFF.
- RX: Direction of motor rotation select. Motor runs in reverse direction when RX terminal is ON.

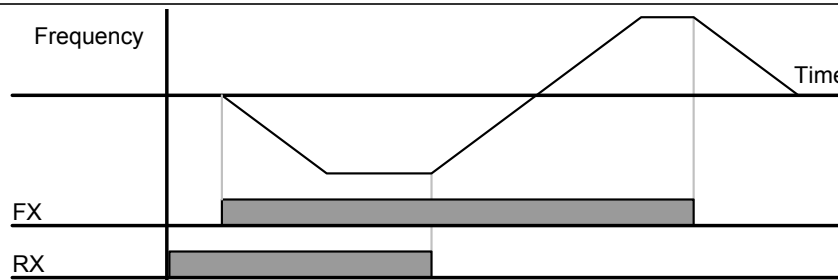

●FX/RX Run Disable

Group	Code	Parameter Name	Setting	Range	Initial	Unit
Drive Group	drC	Direction of motor rotation select	-	F, r	F	
PG Group	P 5	Forward/Reverse run disable	-	0 ~ 2	0	

- Select the direction of motor rotation.
- 0: Forward and Reverse run enable
- 1: Forward run disable
- 2: Reverse run disable

●Power On Start select

Group	Code	Parameter Name	Setting	Range	Initial	Unit
Drive Group	drv	Drive mode	1, 2	0 ~ 3	1	
PG Group	P34	Power on start select	1	0 ~ 1	0	

- Set P34 to 1
- When AC input power is applied to the inverter with drv set to ON, motor starts acceleration.
- It is inactive when it is operated by RUN key.

**! Caution**

Particular attention must be directed to this function due to potential hazard as motor starts to run suddenly upon applying AC input power.

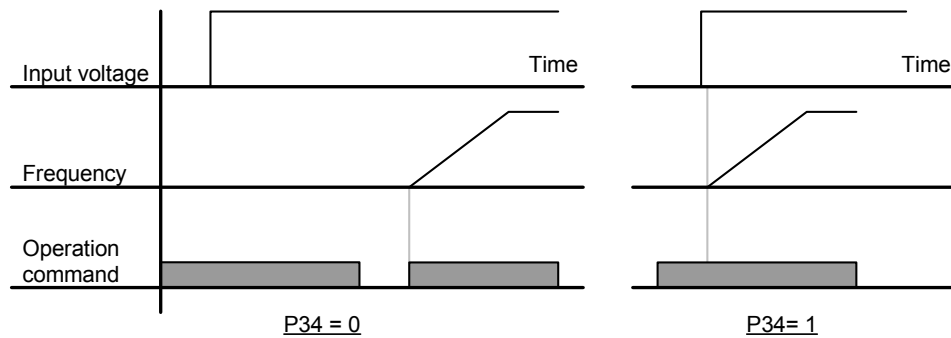

● Restart after fault reset

Group	Code	Parameter Name	Setting	Range	Initial	Unit
Drive Group	drv	Drive mode	1, 2	0 ~ 3	1	
PG Group	P35	Restart after fault reset selection	1	0 ~ 1	0	

- Set P35 code to 1
- When AC input power is applied to the inverter with drv set to ON, motor starts acceleration.
- It is inactive when it is operated by RUN key

**Caution**

Particular attention must be directed to this function due to potential hazard as motor starts to run suddenly after the fault is cleared.

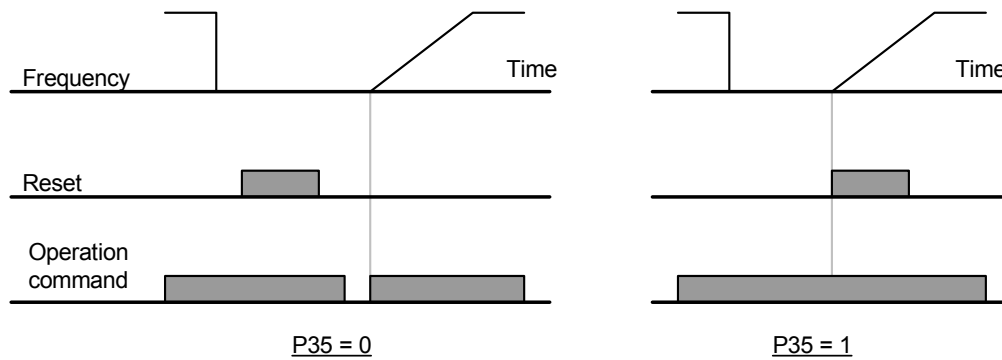

9.4 Accel/Decel time and pattern setting

● Accel/Decel time setting based on Max frequency

Group	Code	Parameter Name	Setting	Range	Initial	Unit
Drive Group	ACC	Accel time	-	0 ~ 6000	5.0	Sec
	dEC	Decel time	-	0 ~ 6000	10.0	Sec
PG Group	P16	Max. freq.	-	0 ~ 200	60.0	Hz

- Set the desired Accel/Decel time at ACC/dEC code in Drive group.
- Accel/decel time means the time accelerating/decelerating from starting frequency up to max. frequency and it forms a pattern of accel/decel time with the max. frequency. Therefore, the slope of same accel/decel pattern within a constant max. frequency is uniform regardless of target frequency.

- ▶ Accel/Decel time is set based on max. frequency and 0Hz. For instance, if it is set max. frequency to 60Hz, Accel/Decel time to 5 sec, and run frequency to 30Hz, time to reach 30Hz would be 2.5 sec.

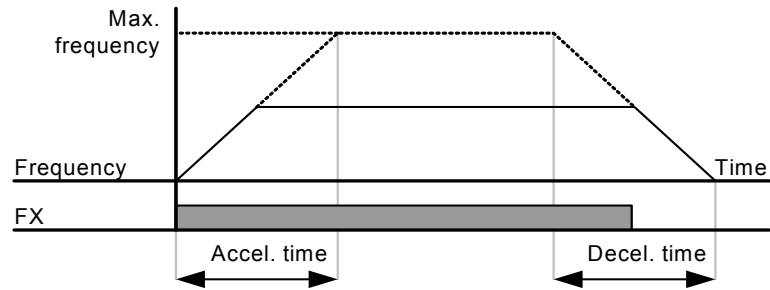

● Accel/Decel pattern setting

Group	Code	Parameter Name	Setting	Range	Initial
PG Group	P 6	Accel pattern	0	Linear pattern run	0
	P 7	Decel pattern	1	S-shape pattern run	

- Accel/decel patterns may be set in P6 and P7 codes of PG Group, respectively.
- Linear pattern operation: Output frequency linearly increases or decreases at uniform incremental
- S-shape pattern run: Used for applications needing smoothing acceleration/deceleration such as conveyor or elevator door.

**Note**

In case of S-shape pattern runs, the accel/decel time is longer than that set by a user. Use linear pattern run in case of application needing accurate accel/decel time.

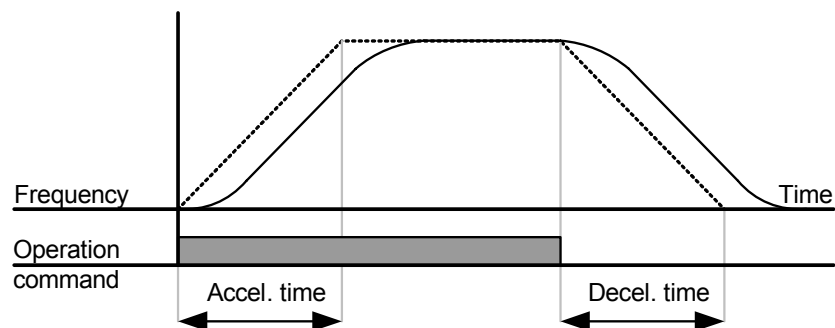



**Note**

If the target frequency is less than 40% of the max. frequency as below figure, it may not realize a complete s-shape pattern run with the ending partially cut.

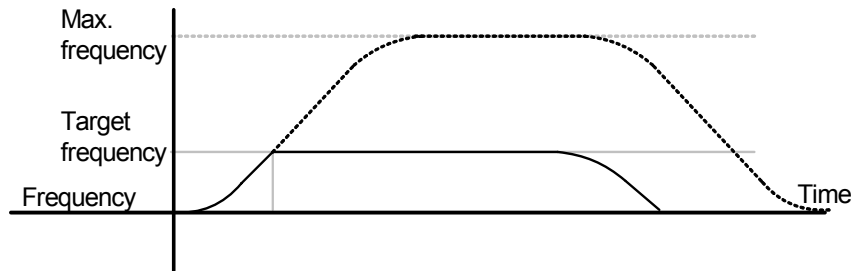

● Accel/Decel Disable

Group	Code	Parameter Name	Setting	Range	Initial	Unit
PG Group	P66	Multi-function input terminal P1 define	-	0 ~ 24	0	
	~	~				
	P70	Multi-function input terminal P5 define	23		4	

- Select one terminal among Multi-function input terminals P1-P5 to define Accel/Decel disable.
- If P5 is selected, set P70 to 23 to activate this function.

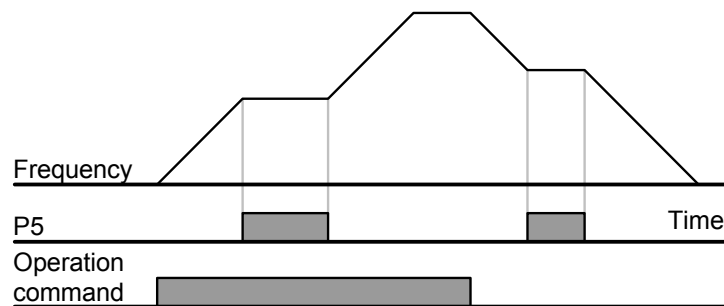

9.5 V/F Control

● Linear V/F pattern operation

Group	Code	Parameter Name	Setting	Range	Initial	Unit
PG Group	P17	Base frequency	-	30 ~ 200	60.0	Hz
	P18	Start frequency	-	0.1 ~ 10	0.5	Hz
	P22	V/F pattern	0	0 ~ 1	0	

- Set P22 code to 0(linear)
- This pattern maintains a linear volts/frequency ratio by voltage/frequency(V/F).

- ▶ Base frequency: Inverter outputs its rated voltage at this level. Enter the motor nameplate frequency.
- ▶ Start frequency: Inverter starts to output its voltage at this level.

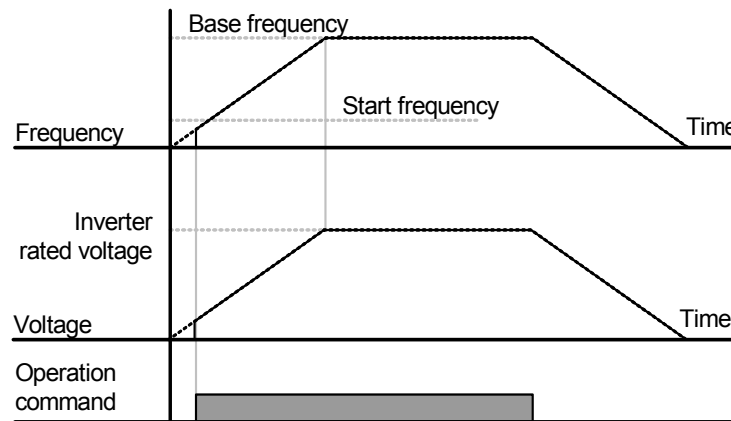

● Square V/F pattern

Group	Code	Parameter Name	Setting	Range	Initial	Unit
PG Group	P22	V/F pattern	1	0 ~ 1	0	

- Set P22 code to 1
- This pattern maintains squared volts. Appropriate applications are fans, pumps, etc

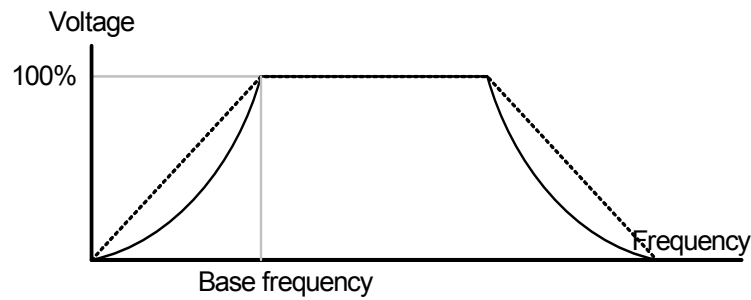

- ▶ In the Squared V/F pattern, to secure operation torque, it is practically realized with approximate value to 1.4 squared.

● Output voltage adjustment

Group	Code	Parameter Name	Setting	Range	Initial	Unit
PG Group	P23	Output voltage adjustment	-	40 ~ 110	100	%

- This function is used to adjust the output voltage of the inverter. This is useful when you use a motor that has a rated voltage lower than the input voltage

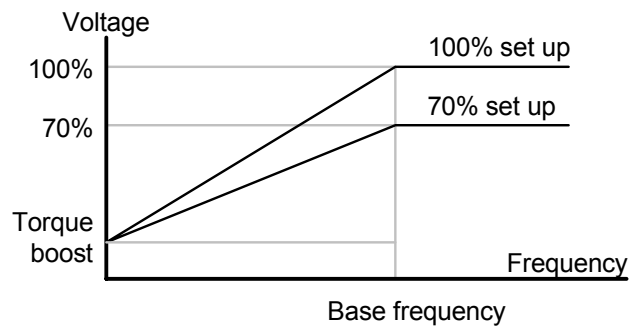

● Manual torque boost

Group	Code	Parameter Name	Setting	Range	Initial	Unit
PG Group	P19	Torque boost select	0	0 ~ 1	0	
	P20	Torque boost in forward direction	-	0 ~ 15	5	%
	P21	Torque boost in reverse direction				

- Set P19 code of PG Group to 0(manual torque boost).
- The values of Torque boost in forward/reverse direction are set separately in P20 and P21.

**Caution**

If the boost value is set much higher than required, it may cause motor overheating due to over-energizing.

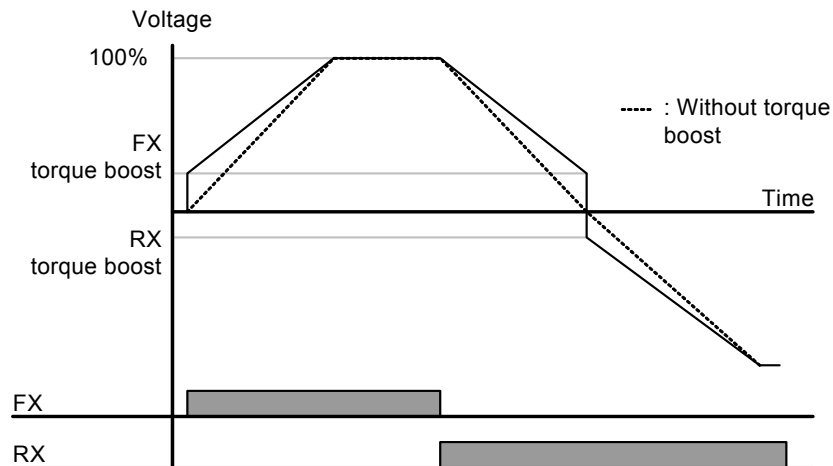

● Auto torque boost

Group	Code	Parameter Name	Setting	Range	Initial	Unit
PG Group	P19	Torque boost select	1	0 ~ 1	0	
PG Group	P44	No load motor current	-	0.1 ~ 25.5	-	A

- Set P19 code of PG Group to 1(auto torque boost).
- Inverter automatically calculates torque boost value using motor parameters and outputs the corresponding voltage.

9.6 Stop method select

● Decel to stop

Group	Code	Parameter Name	Setting	Range	Initial	Unit
PG Group	P 8	Stop mode select	0	0 ~ 2	0	

- Set P8 code of PG Group to 0.
- Motor decelerates to 0 Hz and stops during the setting time.

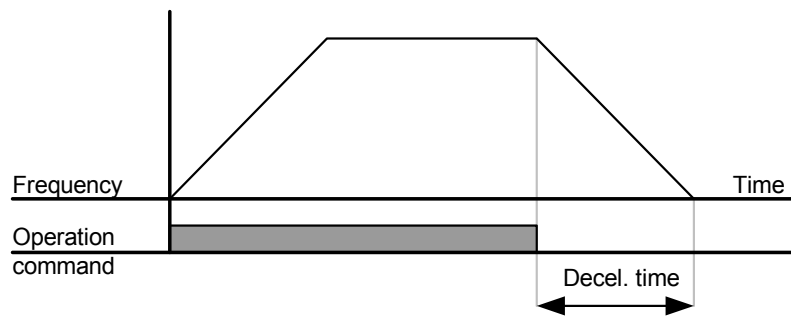

● DC braking to stop

Group	Code	Parameter Name	Setting	Range	Initial	Unit
PG Group	P 8	Stop mode select	1	0 ~ 2	0	

- Select 1(DC brake to stop) in P8 code of PG Group.
- Refer to page 10-1.

● Free run stop

Group	Code	Parameter Name	Setting	Range	Initial	Unit
PG Group	P 8	Stop mode select	2	0 ~ 2	0	

- Select 2(Free run stop) in P8 code of PG Group.
- When operating command is turned OFF, Output Frequency and voltage are shut down.

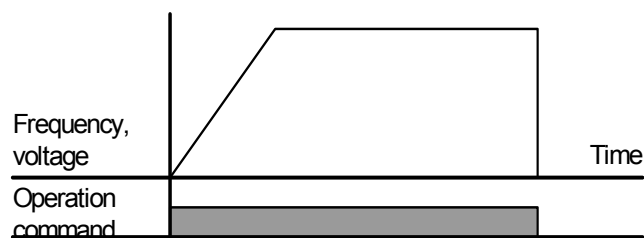

9.7 Frequency limit

● Frequency limit using Max Frequency and Start Frequency

Group	Code	Parameter Name	Setting	Range	Initial	Unit
PG Group	P16	Max frequency	-	0 ~ 200	60.0	Hz
	P18	Start frequency	-	0.1 ~ 10	0.5	Hz

- Max Frequency: Every frequency except P17(base frequency) has upper limit of frequency parameter. Therefore, any frequency cannot be set above the max. frequency.
- Start Frequency: Every frequency has lower limit of frequency parameter.. If a frequency is set lower than this, 0.00 is automatically set.
- Max frequency is the reference frequency serving as the criteria of accel/decel time as well as upper limit. Once max. frequency is changed, accel/decel slope may be changed accordingly.

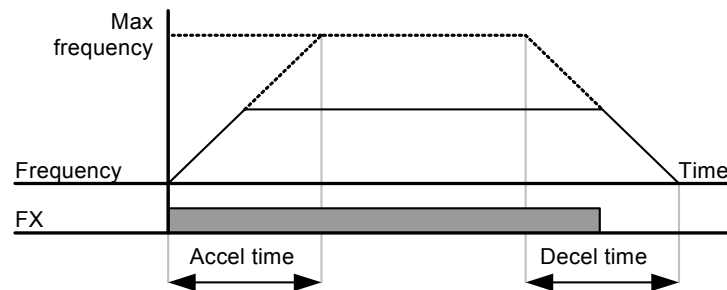



## 10. Advanced Functions

### 10.1 DC Brake

- Stopping motor by DC brake

Group	Code	Parameter Name	Setting	Range	Initial	Unit
PG Group	P 8	Stop mode select	1	0 ~ 2	0	
	P 9	DC brake start frequency	-	0 ~ 60	5.0	Hz
	P10	DC brake wait time	-	0 ~ 60	0.1	sec
	P11	DC brake voltage	-	0 ~ 200	50	%
	P12	DC brake time	-	0 ~ 60	1.0	sec

- Select 1 in P8 code(DC brake stopping) of PG Group
- P 9 : The frequency at which the DC brake will become active
- P10 : Inverter output will hold for this time before applying DC brake voltage.
- P11 : Set this value as a percent of Motor rated current.
- P12 : Sets the time for DC brake voltage to be applied to the motor.

### ! Caution

If excessive DC Brake voltage is set or DC Brake time is set too long, it may cause motor overheating and damage to the motor.

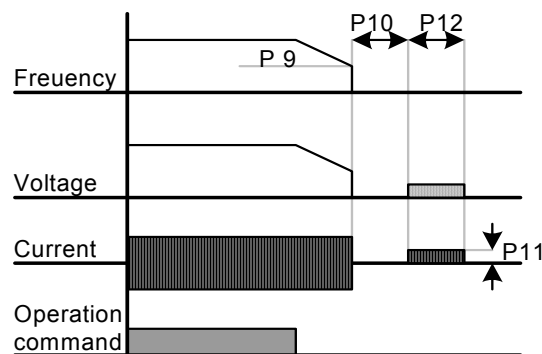

- ▶ Setting P11 or P12 to 0 will disable DC brake.
- ▶ DC Brake Wait time: When load inertia is large, DC brake start frequency is high or excessive DC voltage is allowed to motor, over current trip may occur. It can be prevented using P10 before starting DC brake.



● Starting DC brake

Group	Code	Parameter Name	Setting	Range	Initial	Unit
PG Group	P13	DC brake start voltage	-	0 ~ 200	50	%
	P14	DC brake start time	-	0 ~ 60	0	sec

- P13 : It sets the level as a percent of Motor rated current.
- P14 : Motor accelerates after DC voltage is applied for the set time.

**! Caution**

If excessive DC Brake voltage is set or DC Brake time is set too long, it may cause motor overheating and damage to the motor.

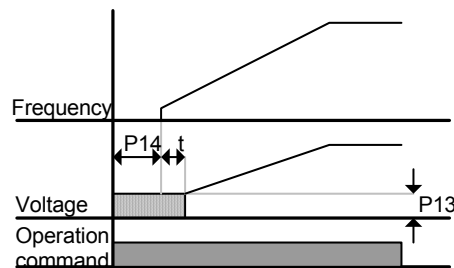

- ▶ Setting P13 or P14 to 0 will disable Starting DC brake.
- ▶ t : After P14, the frequency starts accelerating.

● DC brake at a stop

Group	Code	Parameter Name	Setting	Range	Initial	Unit
PG Group	P13	DC brake start voltage	-	0 ~ 200	50	%
PG Group	P68	Multi-function input terminal P3 function select	11	0 ~ 24	2	

- P13 : It sets the level as a percent of Motor rated current.
- Select a terminal to issue a command of DC brake at a stop among P1 to P5.
- If P3 terminal is set for this function, set P68 to 11(DC brake at a stop).

**! Caution**

If excessive DC Brake voltage at a stop is set or DC Brake time is set too long, it may cause motor overheating and damage to the motor.

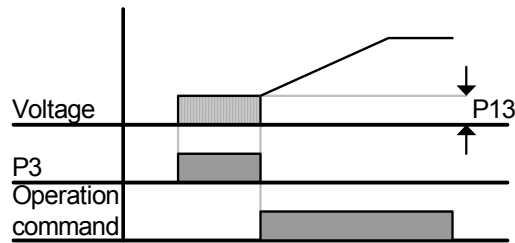

### 10.2 Jog operation

Group	Code	Parameter Name	Setting	Range	Initial	Unit
PG Group	P15	Jog frequency	-	0 ~ 200	10.0	Hz
PG Group	P68	Multi-function input terminal P3 select	4	0 ~ 24	2	

- Set a desirable jog frequency in P15 of PG Group.
- Select a terminal from P1 – P5 to use for this setting
- If P3 is set for Jog operation, set P68 to 4(Jog operation).
- Jog frequency can be set within Max frequency(P16) and Start frequency(P18).

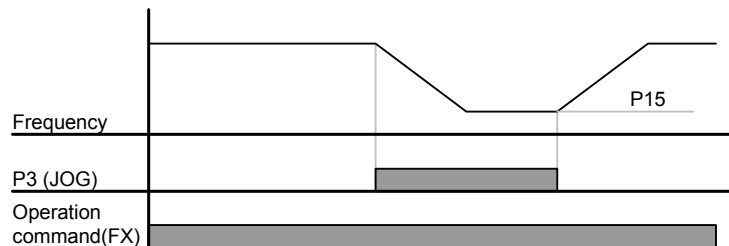
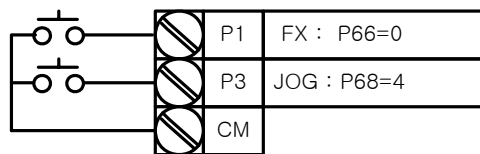

- ▶ Jog operation overrides all other operations except Dwell operation. Therefore, if Jog frequency command is entered in the middle of Multi-Step, Up-Down or 3-wire operation, operation is executed at Jog frequency.
- ▶ The above diagram shows an example when Multi-function input is set to NPN mode.

10.3 UP – DOWN operation

Group	Code	Parameter Name	Setting	Range	Initial	Unit
PG Group	P66	Multi-function input terminal P1 select	0	0 ~ 24	0	
	P68	Multi-function input terminal P3 select	24		2	
	P69	Multi-function input terminal P4 select	15		3	
	P70	Multi-function input terminal P5 select	16		4	

- Select terminals for Up-Down operation from P1-P5.
- If P4 and P5 are selected for Up-Down operation terminals, set P69 and P70 to 15(Frequency Up command) and 16 (Frequency Down command), respectively.

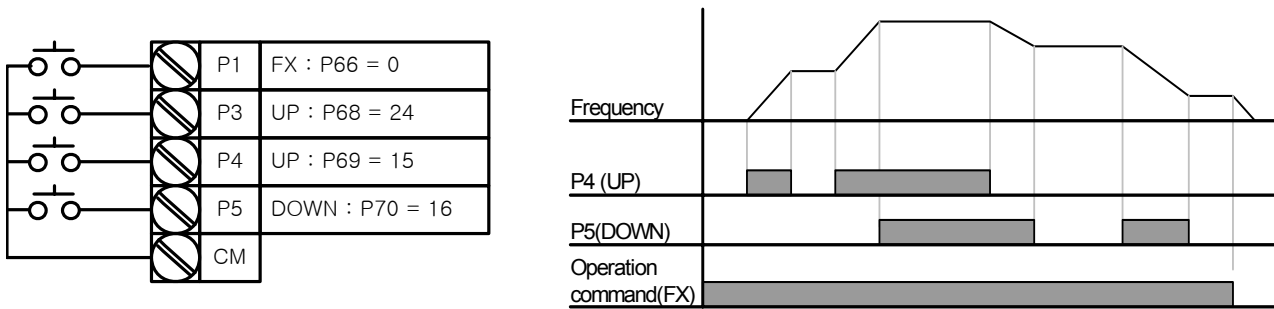

- ▶ Up/down Save function: If P29, 'Save up/down frequency', is set to 1, the frequency before the inverter was stopped or decelerated is saved in P30.

P29	Save up/down frequency select	0	Remove 'save up/down frequency'
		1	Set 'save up/down frequency'
P30	Save up/down frequency	Up/down frequency saved	

- ▶ The Up/down frequency can be initialized by setting of the multi-function input terminal as 'Up/Down Save Frequency Initialization'.
- ▶ If 'Up/Down Save Frequency Initialization' signal is input while the multi-function input 'Up' or 'Down' function is applied, this signal is ignored.

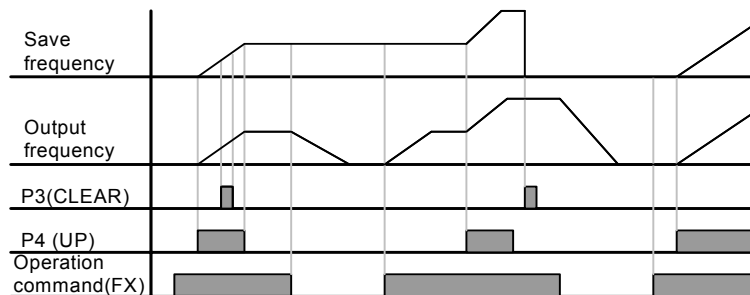

10.4 3-Wire operation

Group	Code	Parameter Name	Setting	Range	Initial	Unit
PG Group	P66	Multi-function Input terminal P1 select]	0	0 ~ 24	0	
	~	~				
	P70	Multi-function Input terminal P5 select	17		4	

- Select a terminal from P1-P5 for use as 3-Wire operation.
- If P5 is selected, set P70 to 17(3-Wire operation).

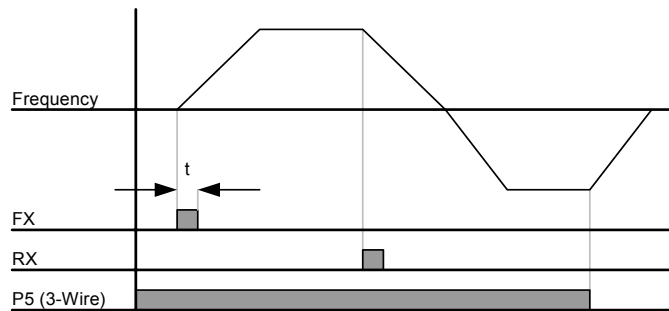
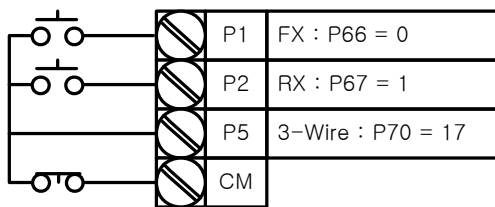

- ▶ Input signal is latched (saved) in 3-Wire operation. Therefore, inverter can be operated by Push-button switch.
- ▶ The bandwidth of pulse (t) should not be less than 50msec.

10.5 Dwell operation

Group	Code	Parameter Name	Setting	Range	Initial	Unit
PG Group	P31	Dwell frequency	-	0 ~ 200	5.0	Hz
	P32	Dwell time	-	0 ~ 10	0.0	sec

- In this setting, a motor begins to accelerate after dwell operation is executed for dwell time at the specified dwell frequency.
- It is mainly used to release mechanical brake in elevators after operating at dwell frequency.

- ▶ Dwell frequency: This function is used to output torque in an intended direction. It is useful in hoisting applications to get enough torque before releasing a mechanical brake. Rated Slip frequency is calculated by the formula shown below.

$$f_s = f_r - \left( \frac{rpm \times P}{120} \right)$$

where,  $f_s$  = rated slip frequency

$f_r$  = rated frequency

$rpm$  = motor rated rpm

$P$  = no. of motor poles

i.e.) rated frequency: 60Hz, rated rpm: 1740rpm, No. of poles: 4

$$f_s = 60 - \left( \frac{1740 \times 4}{120} \right) = 2Hz$$

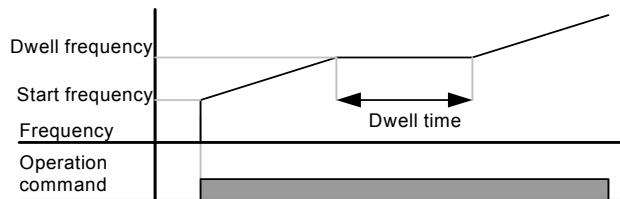

### 10.6 Slip Compensation Control

Group	Code	Parameter Name	Setting	Range	Initial	Unit
PG Group	P40	Motor type select	-	0.1 ~ 0.4	-	
	P41	No. of motor poles	-	2 ~ 12	4	
	P42	Rated slip frequency	-	0 ~ 10	-	Hz
	P43	Motor rated current	-	0.0 ~ 25.5	-	A
	P44	Motor no load current	-	0.0 ~ 25.5	-	A
	P46	Control mode select	1	0 ~ 2	0	

- Set P46 to 1(Slip compensation control).
- This function enables the motor to run in constant speed by compensating inherent slip in an induction motor.

► P46: Set the motor type connected to the inverter output side.

P46	Motor type select	0.1	0.1kW
		0.2	0.2kW
		0.4	0.4kW

- ▶ P41 : Enter the pole number on the Motor nameplate.
- ▶ P42 : Enter the slip frequency in accordance with the following formula and motor nameplate.

$$f_s = f_r - \left( \frac{rpm \times P}{120} \right)$$

where,  $f_s$  = rated slip frequency

$f_r$  = rated frequency

$rpm$  = motor rated rpm

$P$  = motor pole number

i.e.) rated freq. : 60Hz, rated rpm: 1740rpm, poles: 4

$$f_s = 60 - \left( \frac{1740 \times 4}{120} \right) = 2Hz$$

- ▶ Motor function codes per motor type are summarized as follows. Enter motor parameter if any change is required.

● Factory defaults per motor type

Motor type [kW]	Rated current [A]	No load current [A]	Rated slip frequency [Hz]
0.1	0.6	0.4	2.0
0.2	1.1	0.7	2.33
0.4	1.8	1.2	3.00

- ▶ P43: Enter the motor nameplate rated current.
- ▶ P44: Enter the measured current when the motor is running at rated frequency after the load is removed. Enter 50% of the rated motor current when it is difficult to measure the motor no load current.
- ▶ Induction motor has a large difference between motor rated rpm and frequency(synchronous speed) depending on load rate. Therefore, it is recommended to use slip compensation control to reduce the difference.
- ▶ Set torque boost within 2% for slip compensation operation. Excessive torque boost may cause a huge error in slip speed because motor may get overexcitation in low speed.

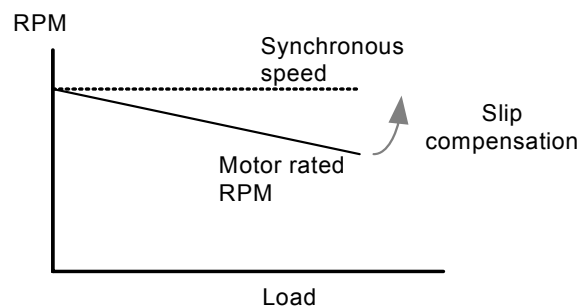

10.7 PI Control

Group	Code	Parameter Name	Setting	Range	Initial	Unit
PG Group	P46	Control mode select	2	0 ~ 3	0	-
	P47	P gain for PI controller	-	0 ~ 999.9	300.0	%
	P48	Differential time for PI controller(I gain)	-	0.1~ 32.0	1.0	sec
	P50	Feed forward gain for PI controller	-	0 ~ 999.9	0	%
	P51	PI output frequency upper limit	-	0 ~ 200	60.0	Hz
	P52	PI output frequency lower limit	-	0 ~ 200	0.5	Hz
	P66~ P70	Multi-function input terminal P1 ~ P5 define	20	0 ~ 24	-	-

- Set P46 to 2(PI control).
- Output frequency of the inverter is controlled by PI control for use as constant control of flow, pressure or temperature.

- ▶ P47: Set the percentage of output to error. If P Gain is set to 50%, 50% of the error value will be output. Higher value can reach the target control value faster but it may cause oscillation.
- ▶ P48: Set the time to output the accumulated error value. Set the time required to output 100% when the error value is 100%. If differential time is set to 1 second and error is 100%, it outputs 100% in 1 second. If the value is reduced, response will be faster but setting too low may lead to controller oscillation.
- ▶ P50: Set the gain to add the target value to the PI controller output.
- ▶ P51, P52: It limits the output of the PI controller.
- ▶ P66 ~ P70: To exchange PI to normal operation, set one of P1~P5 terminal to 20 and turn ON.

● PI Control block diagram

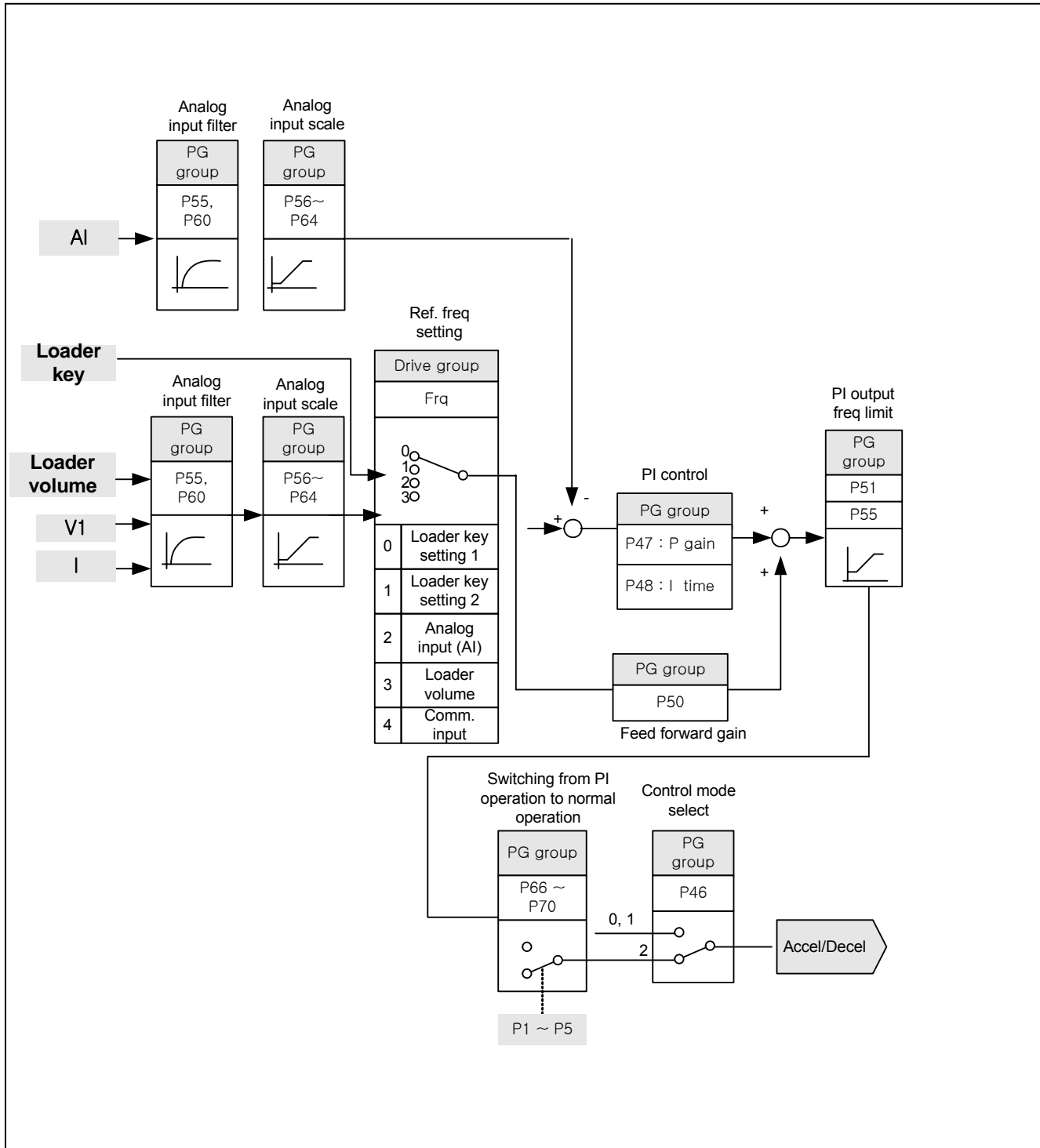



10.8 Speed search operation

Group	Code	Parameter Name	Setting	Range	Initial	Unit
PG Group	P36	Speed search select	-	0 ~ 15	0	
	P37	Speed search current level	-	80 ~ 200	100	%
	P77	Multi-function relay	15	0~20	17	

- Used to avoid any possible fault when the inverter outputs the voltage during operation after the load is removed
- The inverter estimates the motor rpm based on output current. Therefore, detecting exact speed is difficult.

●The following table shows 4 types of Speed search selection.

P36	Speed search	Set	Speed search during P34(power on start)	Speed search during instant power failure restart	Speed search during P35(restart after fault reset)	Speed search during acceleration
			bit 3	bit 2	bit 1	bit 0
		0	-	-	-	-
		1	-	-	-	✓
		2	-	-	✓	-
		3	-	-	✓	✓
		4	-	✓	-	-
		5	-	✓	-	✓
		6	-	✓	✓	-
		7	-	✓	✓	✓
		8	✓	-	-	-
		9	✓	-	-	✓
		10	✓	-	✓	-
		11	✓	-	✓	✓
		12	✓	✓	-	-
		13	✓	✓	-	✓
		14	✓	✓	✓	-
		15	✓	✓	✓	✓

- ▶ P37: Limits current during Speed search. Set as the percent of P43.
- ▶ P77: Signal of active Speed search is given to external sequence via multi-function relay output (30AC).

- ▶ The followings show speed search operation during Instant Power Failure restart

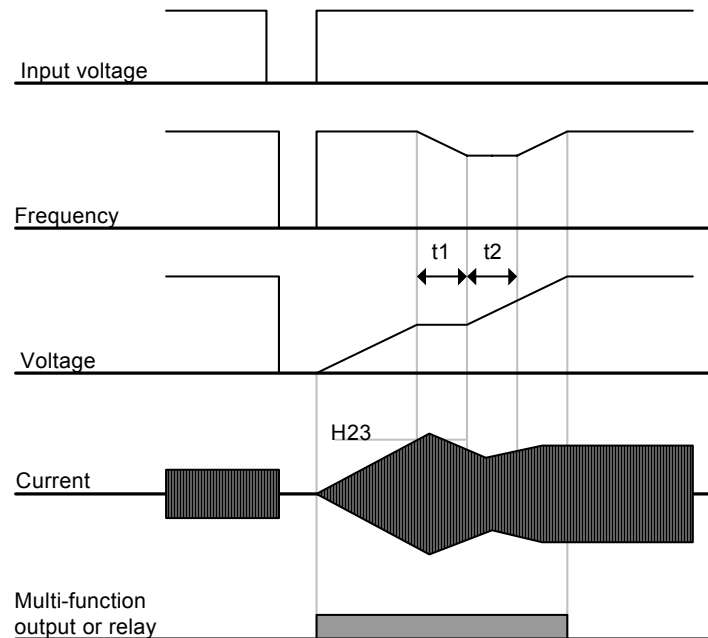

- When the input power is cut off due to instant power failure, the inverter outputs Low voltage trip (LV) to hold the output.
- When the power is restored, the inverter outputs the frequency before the low voltage trip and the voltage is increased due to PI control.
- t1: If current is increasing over the preset level in P37, the rise in voltage will stop and the frequency is decreased.
- t2: If current lowers than the level set in P37, the increase in voltage starts again and the decrease in frequency stops decelerating.
- When the frequency and voltage are restored back to the nominal level, acceleration will continue at the frequency before trip.

- ▶ Speed search operation is suitable for loads with high inertia. Stop the motor and restart when friction in the load is high.
- ▶ SV-iE5 series keeps normal operation when power is restored in 15msec for the use of its inverter rating if it operates within the rated output(0.1kW, 0.2kW and 0.4kW inverter types).
- ▶ Inverter DC link voltage can vary depending on output load quantity. Therefore, Low Voltage trip(Lvt) may occur when instant power failure is maintained over 15msec or output is higher than its rating.
- ▶ Instant power failure specification is applied when input voltage to Inverter is 200~230V AC.
- ▶ Adjust P37(speed search current level) in accordance with motor inertia to accelerate without trip by detecting idle rotation speed quickly, when operation characteristics would be improved if accurately entering motor no load current.

10.9 Auto Restart Operation

Group	Code	Parameter Name	Setting	Range	Initial	Unit
PG Group	P38	No. of auto restart try	-	0 ~ 10	0	
	P39	Auto restart time	-	0 ~ 60	1.0	sec

- Set the frequency of auto restart activated in P38.
- Used to avoid system down, which is caused by internal protection function activated by causes such as noise.

- ▶ P38: If run command is entered after trip as inverter prevention function is active, it automatically restarts in the time set in P39. Auto restart will become active after the P38, which is reduced by 1 when it is active. If the trip outnumbers the preset restart try, auto restart function is deactivated. If the setting is reset via the control terminal or the STOP key on the loader, the number of auto restart try set by user is automatically entered.
- ▶ If there is no more trip for 30 sec after Auto restart operation, it increases the preset auto restart value reduced in the inverter.
- ▶ When operation is stopped due to Low voltage {Lvt} or Emergency stop {EST}, Inverter Overheat {Oht}, and Hardware Trip {HWT}, Auto restart will be deactivated.
- ▶ After the auto restart time set in P39, the motor starts acceleration automatically via speed search.
- ▶ The following pattern is shown when the number of auto restart try is set to 2.

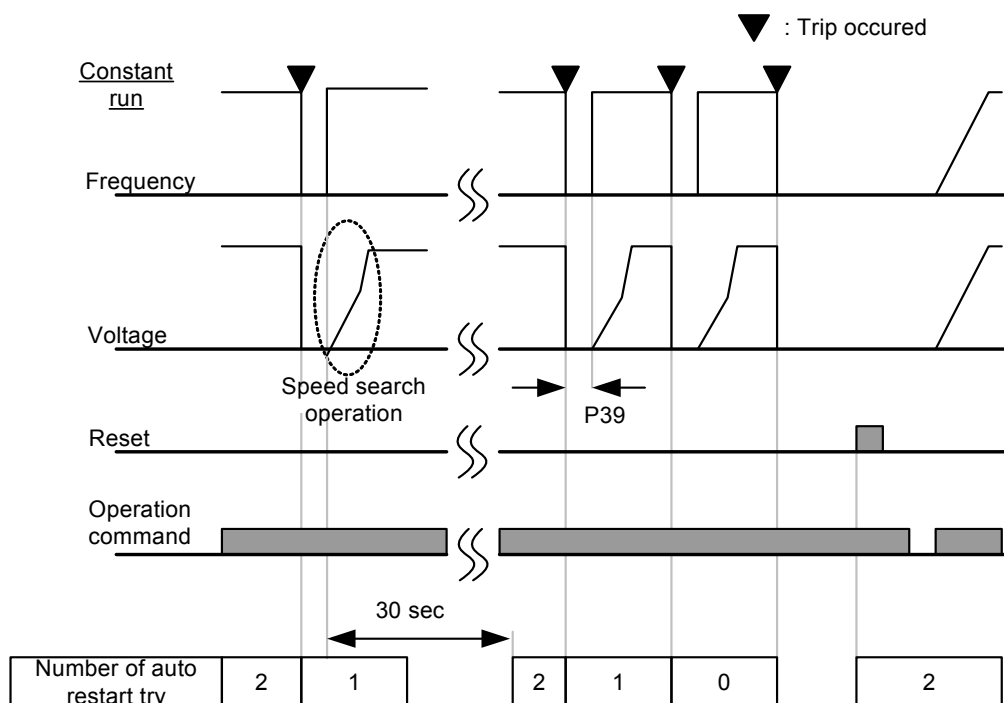

**10.10 Operation Sound Select (carrier frequency change)**

Group	Code	Parameter Name	Setting	Range	Initial	Unit
PG Group	P45	Carrier frequency select	-	0 ~ 15	3	

- Set the operating sound of the inverter.

▶ Operating sound affects the following advantages/disadvantages.

P45	When setting carrier frequency high	Motor sound reduced
		Inverter heat loss increased
		Inverter noise increased
		Inverter leakage current increased

- ▶ iE5 series are designed to monitor the temperature of the inverter's cooling coil(heat sink) in order to automatically adjust carrier frequency in overheating condition. If it is necessary to use high carrier, select inverter type considering ambient temperature and motor load.

**10.11 Parameter initialize/Lock**

●Parameter initialize

Group	Code	Parameter Name	Setting	Range
PG Group	P85	Parameter initialize	0	-
			1	Groups initialize
			2	Drive group initialize
			3	PG group initialize

- Select the group to be initialized and perform it in P85 code.

- ▶ It displays P85 after initialization value is entered in P85 code and initialization is complete by pressing FUNC key.

● Password register





Group	Code	Parameter Name	Setting	Range	Initial	Unit
PG Group	P86	Password register	-	0 ~ FFFF	0	
	P87	Parameter lock	-	0 ~ FFFF	0	

- Register password for parameter lock (P87).
- Password should be hexadecimal (0 ~ 9, A, B, C, D, E, F).

 **Caution**

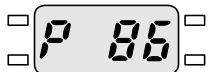
Use the registered password to cancel parameter lock again after setting parameter lock of P86 using the registered password. Therefore, a user should memorize the registered password. If forgetting the password, you need to get after-sales service.

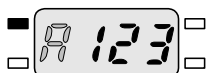
- ▶ Follow the steps to register password.
- ▶ If password is already set, it is necessary to enter the present password instead of 0000 in step 2.

No.	Display	Description
1		- . Move to P86. - . Pressing FUNC key shows 0000.
2		- . Enter the present password and press FUNC key. The factory default password is 0000. - . Press FUNC key.
3		- . Register new password(i.e.: A123) - . If pressing FUNC key, A123 blinks.
4		- . Press FUNC key.
5		- . New password is saved.

- ▶ If the present password is incorrectly entered in step 2, it may not go to step 3. Do not forget the registered password.

●Parameter lock

Group	Code	Parameter Name	Setting	Range	Initial	Unit
PG Group	P87	Parameter lock	-	0 ~ FFFF	0	
	P86	Password register	-	0 ~ FFFF	0	

- Parameter may be protected by using password.

▶ Parameter lock is realized by using the password registered in P86.

No.	Display	Description
1		- . Move to P87. - . Pressing FUNC key shows UL(unlock).
2		- . Display whether or not function code is changeable. - . UL(unlock) shows that function code is changeable. - . Press FUNC key.
3		- . Indicating 0000, the present password entry window is displayed. - . Enter the present password(i.e.: A123).
4		- . Press FUNC key.
5		- . If password is correct, it is changed to L(lock); if incorrect, it shows UL(unlock) again. - . Function code is locked. - . Press FUNC key.
6		- . Initial menu is displayed.

- ▶ If the present status is 'lock' in step 2, it shows L(lock); to cancel it, enter the present password, changing it to UL(unlock).



## 11. Monitoring

### 11.1 Operating Status Monitoring

● Output current

Group	Code	Parameter Name	Setting	Range	Initial	Unit
Drive Group	CUR	Output current	-			

- Inverter output current can be monitored in CUR code.

● Motor RPM

Group	Code	Parameter Name	Setting	Range	Initial	Unit
Drive Group	rPM	Motor RPM	-			
PG Group	P41	No. of motor poles	-	2 ~ 12	4	
	P46	Control mode select	-	0 ~ 2	0	
	P54	Gain for motor rpm display	-	1 ~ 1000	100	%

- Motor rpm can be monitored in rpm code of Drive Group.

- ▶ When P46 is set to 0(V/F control) or 1(PID control), the Inverter output frequency (f) is displayed in RPM using the formula below without Motor slip considered.

$$RPM = \left( \frac{120 \times f}{P41} \right) \times \frac{P54}{100}$$

- ▶ P41: Enter the number of rated motor poles on the nameplate.
- ▶ P54: Enter gear ratio to monitor mechanical rotation, instead of rotation of motor axis.

● Inverter DC link voltage

Group	Code	Parameter Name	Setting	Range	Initial	Unit
Drive Group	dCL	Inverter DC link voltage	-			

- Inverter DC link of input voltage can be monitored in dCL.

- ▶  $\sqrt{2}$  times (1.414) the value of input voltage is displayed while motor is at a stop. This is why it is converted to DC voltage, the maximum of AC voltage by a rectifier.
- ▶ It is the voltage between P1 on the inverter's power terminal and N terminal.



● User display select

Group	Code	Parameter Name	Setting	Range	Initial	Unit
Drive Group	vOL	Output voltage display	-			

- It displays the current inverter output voltage.

● Power on display

Group	Code	Parameter Name	Range	Default	
PG Group	P53	Power on display	0	Frequency command(0.0)	0
			1	Accel time(ACC)	
			2	Decel time(DEC)	
			3	Drive mode(drv)	
			4	Frequency mode(Frq)	
			5	Multi-step frequency 1	
			6	Multi-step frequency 2	
			7	Multi-step frequency 3	
			8	Output current (CUr)	
			9	Motor rpm(rPM)	
			10	Inverter DC link voltage (dCL)	
			11	Output voltage (vOL)	
			12	Fault display 1	
			13	Operating display select	
			14	Output current	
15	Motor rpm				

- Display the parameters set in P53 when power on.
  - ▶ The output current and motor rpm are displayed directly when P53 is set 14,15.

### 11.2 Monitoring I/O Terminal

● Input terminal status monitoring

Group	Code	Parameter Name	Setting	Range	Initial	Unit
PG Group	P71	Input terminal status display	-			

- Current input terminal status (ON/OFF) can be monitored in P71.
  - The following is displayed when P1, P3, P4 are ON and P5 is OFF.

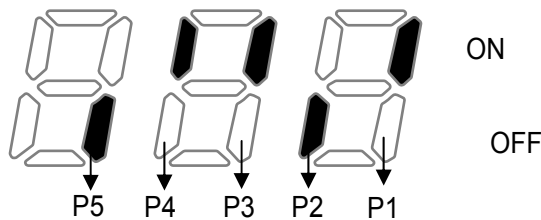

### 11.3 Monitoring Fault Condition

● Monitoring Current Fault Status

Group	Code	Parameter Name	Setting	Range	Initial	Unit
Drive Group	nOn	Current fault display	-			

- Fault occurred during operation is displayed in nOn
- Up to 3 kinds of faults can be monitored.

▶ This parameter gives information on fault types and the operating status at the time of the fault in good order of fault type -> frequency -> current -> accel/decel. Refer to Page 5-10 for keypad setting.

Fault types	Frequency			
	Current			
	Accel/decel information		Fault during accel	
			Fault during decel	
			Fault during constant run	
		Fault at a stop		

▶ Refer to Page 13-1 on fault types.

● Fault history monitoring

Group	Code	Parameter Name	Setting	Range	Initial	Unit
PG Group	P 1	Fault history 1	-			
	P 2	Fault history 2				
	P 3	Fault history 3				
	P 4	Reset fault history	-	0 ~ 1	0	

- P 1 ~ P 3: Up to 3 faults information is stored.
- P 4: Previous fault information stored in the code P1 thru P3 is all cleared.

- ▶ When a fault occurs during operation, it can be monitored in the nOn.
- ▶ When the fault condition is reset via the STOP/RST key or multi-function terminal, information displayed in the nOn will be moved to P1. In addition, the previous fault info stored in P1 will be automatically moved to P2. Therefore, the latest update fault info will be stored in the lowest history number.
- ▶ When more than 1 fault occurred at the same time, up to 3 types of faults will be stored in one code.

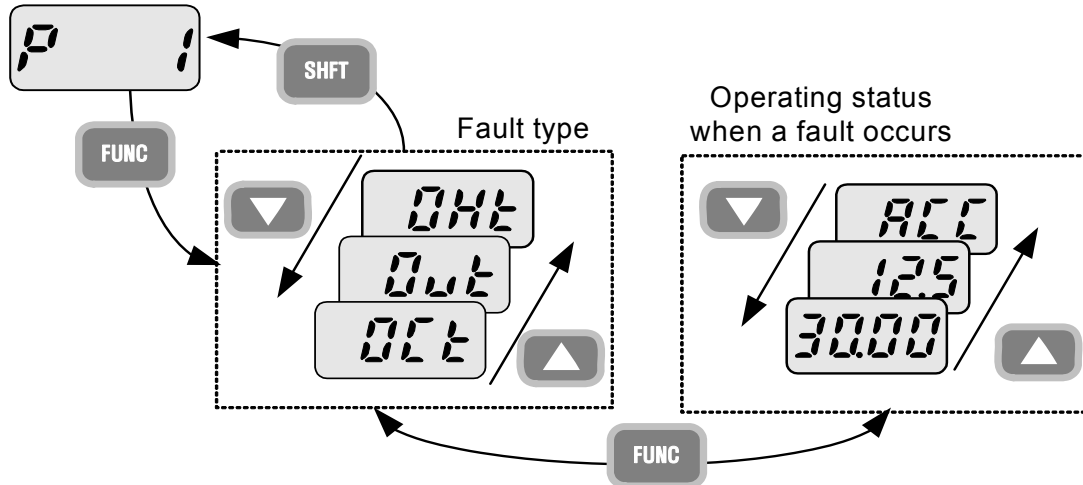

Note

Among faults displayed, ESt(emergency stop) and Lvt(low voltage trip) are not stored in fault history.

11.4 Analogue output

Group	Code	Parameter Name	Setting	Range	Initial	Unit
PG Group	P73	Analogue output item select	-	0 ~ 3	0	
	P74	Analogue output level adjustment	-	10 ~ 200	100	%

- Output item and the level from the AM terminal are selectable and adjustable.

▶ P73: The selected item will be output to Analog output terminal (AM).

P73	Analogue output item select		Item corresponding to 10V
	0	Output frequency	Max. frequency(P16)
	1	Output current	150% of inverter rated current
	2	Output voltage	282Vac
	3	Inverter DC link voltage	400Vdc

- ▶ P74: If you want to use analog output value as a gauge input, the value can be adjustable according to various gauge specifications.

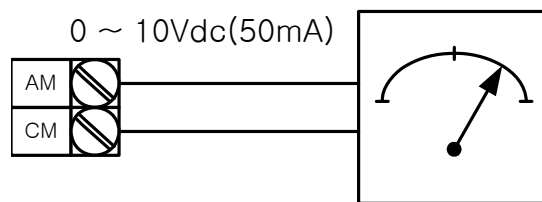

11.5 Multi-function output terminal and Relay

Group	Code	Parameter Name	Range			Default	
PG Group	P77	Multi-function output terminal select	0	FDT-1		17	
			1	FDT-2			
			2	FDT-3			
			3	FDT-4			
			4	FDT-5			
			5	-			
			6	Inverter overload(IOL)			
			7	Motor stall(STALL)			
			8	Over voltage trip(Ovt)			
			9	Low voltage trip(Lvt)			
			10	Inverter overheat(OHt)			
			11	Command loss			
			12	During run			
			13	During stop			
			14	During constant run			
			15	During speed searching			
			16	Wait time for run signal input			
17	Fault output						
	P78	Fault relay output	Type	When setting H26(number of auto restart tries)	When the other than low voltage trip occurs	When the low voltage trip occurs	2
			Set	bit 2	bit 1	bit 0	
			0	-	-	-	
			1	-	-	✓	
			2	-	✓	-	
			3	-	✓	✓	
			4	✓	-	-	
			5	✓	-	✓	
			6	✓	✓	-	
7	✓	✓	✓				

- Select the desired item to be output.

- ▶ P78: When 17(Fault display) is selected in P77, Multi-function output relay will be activated with the value in P78.

●0 : FDT-1

- ▶ Check whether the output frequency matches the user-setting frequency.
- ▶ Active condition: Absolute value (preset frequency-output frequency) <= Frequency Detection Bandwidth/ 2

Group	Code	Parameter Name	Setting	Range	Initial	Unit
PG Group	P76	Detected frequency bandwidth	-	0 ~ 200	10.0	Hz

- Can not be set above max. frequency(P16).

- ▶ When setting P76 to 10.0.

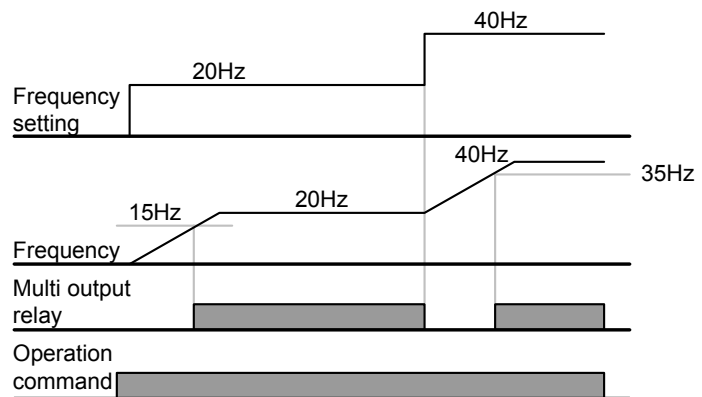

●1 : FDT-2

- ▶ Activated when the preset frequency matches frequency detection level (P75) and FDT-1 condition is met.
- ▶ Active condition: (Preset frequency = FDT level) & FDT-1

Group	Code	Parameter Name	Setting	Range	Initial	Unit
PG Group	P75	Detected frequency	-	0 ~ 200	30.0	Hz
	P76	Detected frequency bandwidth	-		10.0	

- Cannot be set above Max frequency (P16).

- ▶ When setting P75 and P76 to 30.0 Hz and 10.0 Hz, respectively

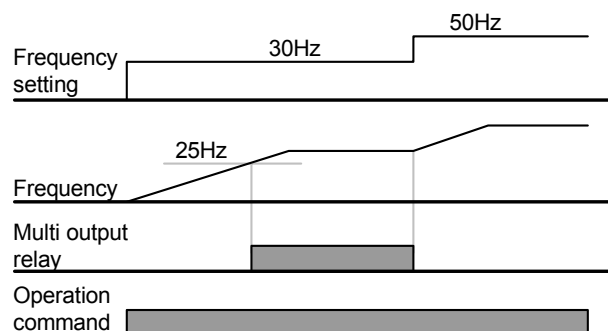

●2 : FDT-3

- ▶ Activated when run frequency meets the following condition.
- ▶ Active condition: Absolute value (detected frequency - run frequency)  $\leq$  detected frequency Bandwidth/2

Group	Code	Parameter Name	Setting	Range	Initial	Unit
PG Group	P75	Detected frequency	-	0 ~ 200	30.0	Hz
	P76	Detected frequency bandwidth	-		10.0	

- Can not be set above max. frequency(P16).

- ▶ When setting P75 and P76 to 30.0Hz and 10.0 Hz, respectively

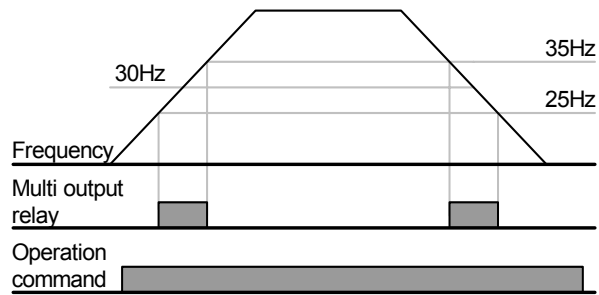

●3 : FDT-4

- ▶ Activated when run frequency meets the following condition.
- ▶ Active condition

Accel time: Run Frequency  $\geq$  FDT Level

Decel time: Run Frequency  $>$  (FDT Level – FDT Bandwidth/2)

Group	Code	Parameter Name	Setting	Range	Initial	Unit
PG Group	P75	Detected frequency	-	0 ~ 200	30.0	Hz
	P76	Detected frequency bandwidth	-		10.0	

- Can not be set above max. frequency(P16).

- ▶ When setting P75 and P76 to 30.0Hz and 10.0 Hz, respectively

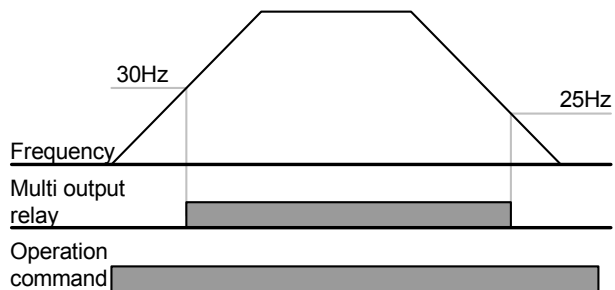

●4 : FDT-5

- ▶ Activated as B contact contrast to FDT-4.
- ▶ Active condition

Accel time: Run Frequency >= FDT Level

Decel time: Run Frequency > (FDT Level – FDT Bandwidth/2)

Group	Code	Parameter Name	Setting	Range	Initial	Unit
PG Group	P75	Detected frequency	-	0 ~ 200	30.0	Hz
	P76	Detected frequency bandwidth	-		10.0	

- Can not be set above max. frequency(P16).

- ▶ When setting P75 and P76 to 30.0Hz and 10.0 Hz, respectively

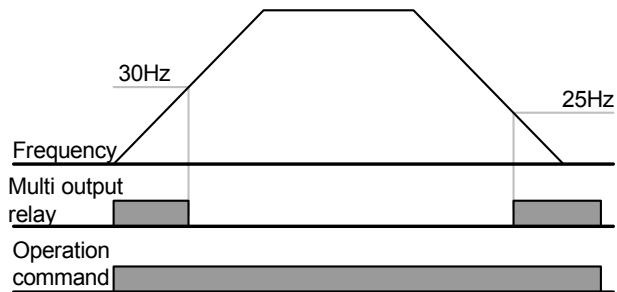

●5 : Overload (OL)

- ▶ Refer to page 12-1.

●6 : Inverter overload (IOL)

- ▶ Refer to page 12-5

●7 : Motor stall (Stall)

- ▶ Refer to page 12-1

●8 : Over voltage trip (Ovt)

- ▶ Activated when over voltage trip occurs due to DC link voltage exceeded 400VDC.

●9 : Low voltage trip (Lvt)

- ▶ Activated when low voltage trip occurs due to DC link voltage under 200V.

●10 : Inverter heatsink overheat (OHt)

- ▶ Activated when the heatsink is overheated

●11 : Command loss

- ▶ Activated when analogue or RS-485 communication command are lost. Refer to page 12-4 frequency input loss.



●12 : During operation

- ▶ Activated when run command is input and inverter outputs its voltage.

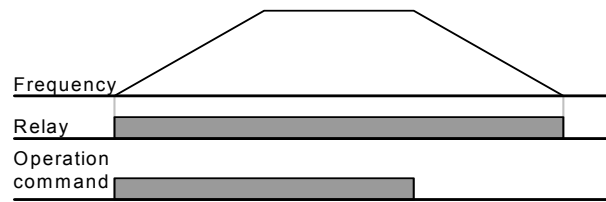

●13 : During stop

- ▶ Activated during stop without active command

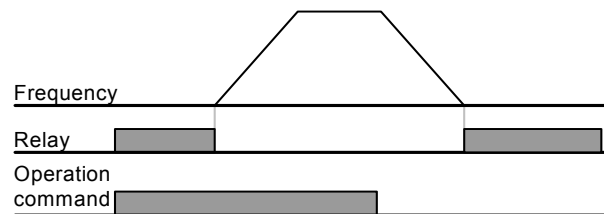

●14 : During constant run

- ▶ Activated during constant speed operation

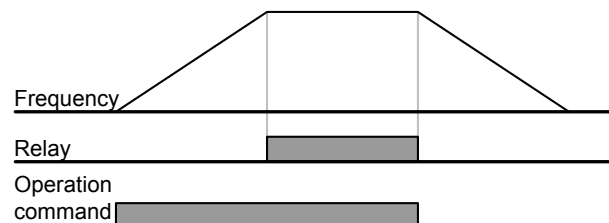

●15 : During speed searching

- ▶ Refer to page 10-10

●16 : Wait time for run signal input

- ▶ This function becomes active during normal operation and that the inverter waits for active run command from external sequence.

●17 : Fault output

- ▶ The parameter set in P78 is activated.
- ▶ For example, if setting P77, P78 to 17 and 2, respectively, Multi-function output relay will become active when trip other than “Low voltage trip” occurred.

## 12. Protective Function

### 12.1 Overload Trip

Group	Code	Parameter Name	Setting	Range	Initial	Unit
PG Group	P24	Overload trip select	1	0 ~ 1	0	
	P25	Overload trip level	-	30 ~ 200	180	%
	P26	Overload trip time	-	0 ~ 60	60	sec

- Set P24 of PG Group to 1.
- Cut the inverter's output in case of motor overload
- Cut the output if current is allowed to motor during overload trip time higher than the preset level.

### 12.2 Stall prevention

Group	Code	Parameter Name	Setting	Range	Initial	Unit
PG Group	P27	Stall prevention select	-	0 ~ 7	3	
	P28	Stall prevention level	-	30 ~ 150	150	%
	P77	Multi-function relay select	7	0 ~ 18	17	

- During acceleration: Motor starts deceleration when current exceeding the value set in P28 flows
- During constant run: Motor decelerates when current exceeding the value set in P28 flows.
- During deceleration: Motor deceleration stops when inverter DC link voltage rises above a certain voltage level.
- P28: The value is set as the percent of motor rated current (P43).
- P77: Inverter outputs signals of stall prevention operation to externally connected device through multi-function relay output (30AC).

▶ P27 : Stall prevention can be set as the table below

Set	Decel	Constant	Accel	Set	Decel	Constant	Accel
0		-	-	4		✓	-
1		-	✓	5		✓	✓
2		✓	-	6		✓	-
3		✓	✓	7		✓	✓

- ▶ For example, set P27 to 3 to make stall prevention active during Acceleration and constant run.
- ▶ When stall prevention is executed during acceleration or deceleration, Accel/Decel time may take longer than the user-setting time.
- ▶ When stall prevention is activated during constant run, t1, t2 executed in accordance with the value set in ACC - [Accel time] and dEC - [Decel time].

i.e.) Stall prevention during operation

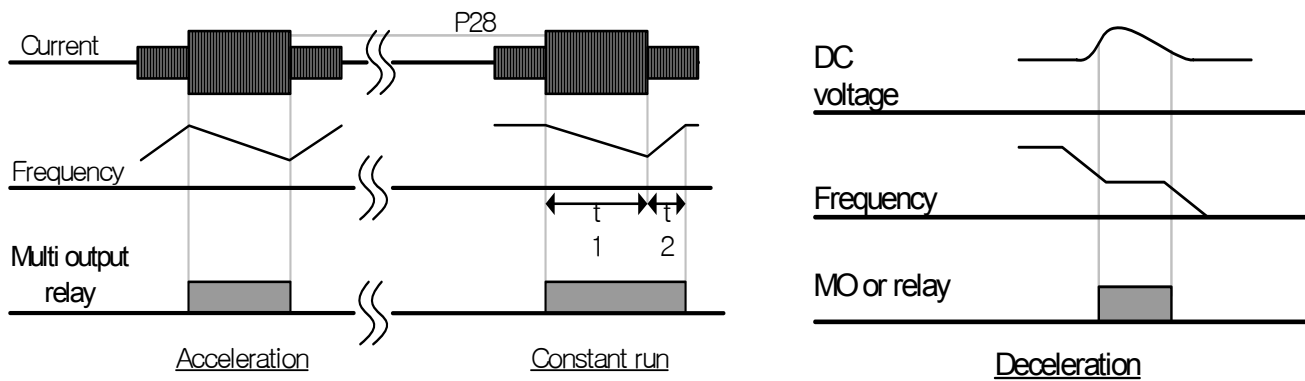

### 12.3 User's fault detection

Group	Code	Parameter Name	Setting	Range	Initial	Unit
PG Group	P33	User's fault detection	3	0 ~ 7	0	

- Can set the following fault detection.
- Ground fault detection during operation: it stops output if excessive current of one or more outputs flows due to ground fault and etc.
- Input phase loss: Inverter output is blocked at the event of more than one phase loss among R, S and T.
- Output phase loss: Inverter output is shut off at the event of more than one phase loss among U, V and W.

### Caution

Set P43(Motor rated current) correctly. If the actual motor rated current and the value of P43 are different, output phase loss protection function could not be activated.

Display	Ground fault during operation [GCt]	Input phase loss [COL]	Output phase loss [Pot]	Display	Ground fault during operation [GCt]	Input phase loss [COL]	Output phase loss [Pot]
0	-	-	-	4	✓	-	-
1	-	-	✓	5	✓	-	✓
2	-	✓	-	6	✓	✓	-
3	-	✓	✓	7	✓	✓	✓

12.4 External trip signal

Group	Code	Parameter Name	Setting	Range	Initial	Unit
PG Group	P66	Multi-function input terminal P1 define		0 ~ 24	0	
	~	~				
	P69	Multi-function input terminal P4 define	18		3	
	P70	Multi-function input terminal P5 define	19		4	

- Select a terminal among P1 ~ P5 to output external trip signal.
- Set P69 and P70 to 18 and 19 to define P4 and P5 as External A contact and B contact.

- ▶ External trip signal input A contact (N.O.): At normal status, P4 and CM terminals are open while at fault, inverter output is shut off.
- ▶ External trip signal input B contact (N.C.): At normal status, P5 and CM terminals are open while at open, inverter output is shut off.

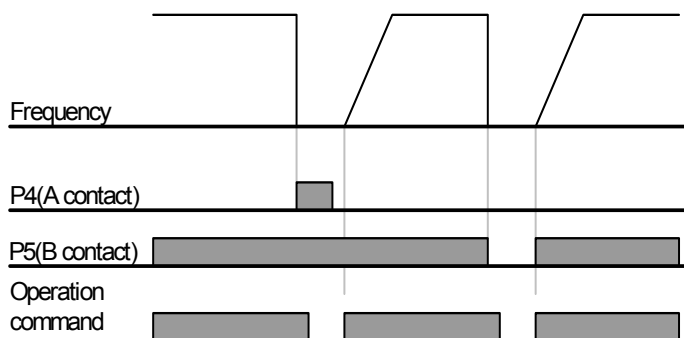
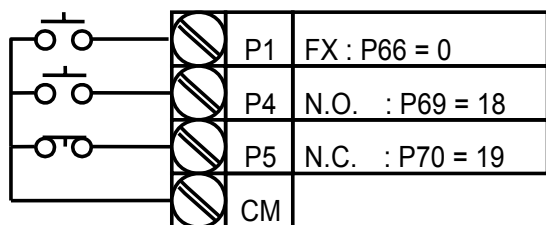

12.5 Frequency command loss

Group	Code	Parameter Name	Setting	Range	Initial	Unit
PG Group	P65	Criteria for analogue input signal	0	0 ~ 2	0	
	P81	Drive mode select after loss of frequency command	-	0 ~ 2	0	
	P82	Wait time after loss of frequency command	-	0.1~120	1.0	sec
	P77	Multi-function relay select	11	0 ~ 18	17	

- Select the Drive mode when frequency reference set via analog signal or communication option is lost.

▶ P65: Set the criteria for analog input signal loss.

P65	Criteria for analogue input signal loss	0	Disabled
		1	When half the value set in P56 and P61 is entered
		2	When less than the value set in P56 and P61 is entered

- ▶ If frequency command is set to 3(V1 of terminal) in Frq code of Drive Group and P65 is set to 1 and when AI is less than half the value set in P56, it determines frequency command loss. At the moment, if entering current based on the value converting 0~10V to 0~100%, it operates with the value converting 0~20mA to 0~100%.

i.e.) Voltage input: If P56 and P65 are set to 50% and 2 respectively, it operates at 5V.

Current input: If P56 and P65 are set to 50% and 1 respectively, it operates at 5mA.

▶ P81: When the conditions set in P65 are met for the time set in P82, the inverter operates as follows.

P81	Drive mode select after loss of frequency command	0	Continuous operation with the frequency before command loss occurs
		1	Free run stop (output cut off)
		2	Decel to stop

- ▶ P77: Multi-function relay output (30AC) is used to output information on loss of frequency command to external sequence.

i.e.) when P65 is set to 2, P81 to 2, P82 to 5.0 sec and P77 to 11, respectively,

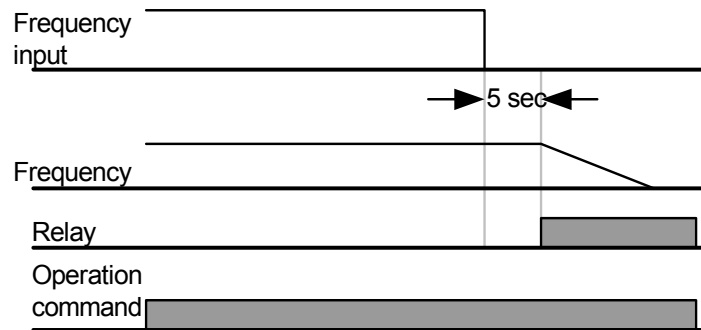

12.6 Inverter overload

Group	Code	Parameter Name	Setting	Range	Initial	Unit
PG Group	P77	Multi-function output terminal select	6	0 ~ 17	17	

- ▶ Inverter overload prevention function is activated when the current above inverter rated current flows. At the moment, the operation time becomes shorter as larger output current is.
- ▶ Multi-function relay (30BC) is used to output it to external device during inverter overload trip.
- ▶ Inverter overload trip operates as follows. However, level and time may vary automatically in accordance with motor type, depending on settings including carrier frequency.

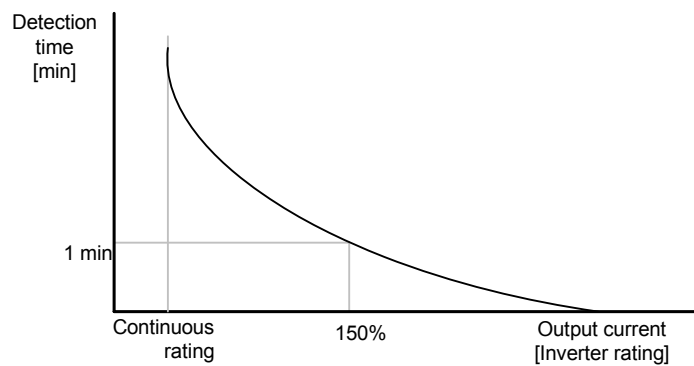



## 13. Troubleshooting and Maintenance

### 13.1 Protective Functions



## Caution



When a fault occurs, the cause must be corrected before the fault can be cleared. If protective function keeps active, the inverter should restart after clearing the cause(s). Or, it may lead to reduction in product life and damage to the equipment.

● Protection of Inverter output current and input voltage

Fault display	Protective function	Description
	Overcurrent	The inverter turns off its output when the output current of the inverter flows more than 200% of the inverter rated current
	Ground fault current	The inverter turns off its output when a ground fault occurs on the output as long as the function is active.
	Ground fault current	The inverter turns off its output when unbalanced output current occurs due to abnormal situation such as ground fault during run and one of U,V,W gets overcurrent.
	Inverter Overload	The inverter turns off its output when the output current of the inverter flows more than the rated level (150% for 1 minute).
	Overload trip	The inverter turns off its output if the output current of the inverter more than the motor rated current(P25) flows.
	Inverter overheat	The inverter turns off its output if the heat sink overheats due to a damaged cooling fan.
	Condenser overload	Inverter output is blocked when one of 3 phases gets opened or main condenser is outworn, resulting in excessive DC voltage variation. Detection time varies depending on inverter output current.
	Output Phase loss	The inverter turns off its output when the one or more of the output (U, V, W) phase is open. The inverter detects the output current to check the phase loss of the output.
	Over voltage	The inverter turns off its output if the DC voltage of the main circuit increases higher than 400 V when the motor decelerates. This fault can also occur due to a surge voltage generated at the power supply system.
	Low voltage	The inverter turns off its output if the DC voltage is below 180V because of insufficient voltage input torque.



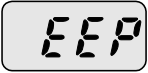
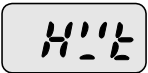
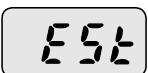
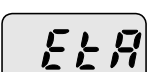
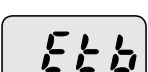





●Protection of abnormal internal circuit and external signal

Fault display	Protective function	Description
	Parameter save error	Displayed when user-setting parameters fail to be entered into memory.
	Inverter hardware fault	Displayed when an error occurs in CPU operation and internal OS program. The fault may not be relieved simply by STOP/RST key of the loader or reset terminal. Retry after completely turning off the inverter and the display of the loader is fully disappeared.
	Instant cut off	Used for the emergency stop of the inverter. The inverter instantly turns off the output when the EST terminal is turned on. <b>Note</b> The inverter starts to regular operation when turning off the EST terminal while FX or RX terminal is ON.
	External fault A contact input	When multi-function input terminal (P66~P70) is set to 18, external fault signal input: A (Normal Open Contact), the inverter turns off the output.
	External fault B contact input	When multi-function input terminal (P66 ~ P70) is set to 19, external fault signal input: B (Normal Close Contact), the inverter turns off the output.
	When the frequency command is lost	When inverter operation is set via Analog input (0-10V or 0-20mA input) or option (RS-485) and no signal is applied, operation is done according to the method set in P81.



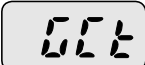

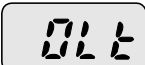

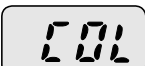

13.2 Fault Remedy

 **Caution**

If any trouble occurs due to overcurrent, make sure to restart after eliminating the causes because power semiconductor element inside the inverter may be broken.

Protective function	Cause	Remedy
 Overcurrent	<ul style="list-style-type: none"> <li>● Accel/Decel time is too short compared to the inertia of the load(<math>GD^2</math>).</li> <li>● Load is greater than the inverter rating.</li> <li>● Inverter output is issued when the motor is free running.</li> <li>● Output short circuit or ground fault has occurred.</li> <li>● Mechanical brake of the motor is operating too fast.</li> </ul>	<ul style="list-style-type: none"> <li>☞ Increase the Accel/Decel time.</li> <li>☞ Replace the inverter with appropriate capacity.</li> <li>☞ Resume operation after stopping the motor or use P36 (Speed search).</li> <li>☞ Check output wiring.</li> <li>☞ Check the mechanical brake.</li> </ul>
  Ground fault current	<ul style="list-style-type: none"> <li>● Ground fault has occurred at the output wiring of the inverter.</li> <li>● The insulation of the motor is damaged due to heat.</li> </ul>	<ul style="list-style-type: none"> <li>☞ Check the wiring of the output terminal.</li> <li>☞ Replace the motor.</li> </ul>
 Inverter overload	<ul style="list-style-type: none"> <li>● Load is greater than the inverter rating.</li> <li>● Torque boost scale is set too large.</li> </ul>	<ul style="list-style-type: none"> <li>☞ Upgrade the capacity of motor and inverter or reduce the load weight.</li> <li>☞ Reduce torque boost scale.</li> </ul>
 Overload trip		
 Inverter overheat	<ul style="list-style-type: none"> <li>● Cooling system has faults.</li> <li>● Ambient temperature is too high.</li> </ul>	<ul style="list-style-type: none"> <li>☞ Check for alien substances clogged in the heat sink.</li> <li>☞ Keep ambient temperature under 40°C.</li> </ul>
 Condenser overload	<ul style="list-style-type: none"> <li>● 3-Phase product may have one phase lost.</li> <li>● Internal condenser was outworn.</li> </ul>	<ul style="list-style-type: none"> <li>☞ Check whether wiring of input power or inter-phase voltage is abnormal.</li> <li>☞ It's almost time to replace or it may happen when it is used in hot temperature for a long while. Contact after-sales service.</li> </ul>

● Fault Remedy

Protective function	Cause	Remedy
 Output Phase loss	<ul style="list-style-type: none"> <li>● Faulty contact of magnetic switch at output</li> <li>● Faulty output wiring</li> </ul>	<ul style="list-style-type: none"> <li>☞ Make connection of magnetic switch at output of the inverter securely.</li> <li>☞ Check output wiring.</li> </ul>
 Over voltage	<ul style="list-style-type: none"> <li>● Decel time is too short compared to the inertia of the load(<math>GD^2</math>).</li> <li>● Regenerative load is at the inverter output.</li> <li>● Line voltage is too high.</li> </ul>	<ul style="list-style-type: none"> <li>☞ Increase the Decel time.</li> <li>☞ Check whether line voltage exceeds its rating.</li> </ul>
 Low voltage	<ul style="list-style-type: none"> <li>● Line voltage is low.</li> <li>● Load larger than line capacity is connected to line (ex: welding machine, motor's direct input)</li> <li>● Faulty magnetic switch at the input side of the inverter.</li> </ul>	<ul style="list-style-type: none"> <li>☞ Check whether line voltage is below its rating.</li> <li>☞ Check the incoming AC line. Adjust the line capacity corresponding to the load.</li> <li>☞ Change a magnetic switch.</li> </ul>
 External fault A contact input	<ul style="list-style-type: none"> <li>● The multi function terminals(P66 ~ P70) set to "18 (External fault-A)" or "19 (External trip signal input : fault-B)" in P66~P70 in PG Group is ON.</li> </ul>	<ul style="list-style-type: none"> <li>☞ Eliminate the cause of fault at circuit connected to external fault terminal or cause of external fault input.</li> </ul>
 External fault B contact input		
	<ul style="list-style-type: none"> <li>● No frequency command is applied to AI terminal.</li> <li>● Communication command is cuts off</li> </ul>	<ul style="list-style-type: none"> <li>☞ Check the wiring of AI and frequency reference level.</li> <li>☞ In case of a program set to periodically update frequency, check the communication line or operation of master device.</li> </ul>
  Parameter save error Hardware fault		<ul style="list-style-type: none"> <li>☞ Contact your local LSIS sales representative.</li> <li>☞ EEP message occurs when first allowing power after upgrading software due to A/S service. At the moment, turn it off and retry.</li> </ul>

13.3 Precautions for maintenance

 **Warning**

- Make sure to remove the input power while performing maintenance.
- Make sure to perform maintenance after checking the DC link capacitor has discharged. The bus capacitors in the inverter main circuit can still be charged even after the power is turned off. Check the voltage between terminal P or P1 and N using a tester before proceeding.
- SV-iE5 series inverter has ESD (Electrostatic Discharge) sensitive components. Take protective measures against ESD before touching them for inspection or installation.
- Do not change any inner parts and connectors. Never modify the inverter.

13.4 Checklist

- Daily inspections
  - ▶ Proper installation environment
  - ▶ Cooling system fault
  - ▶ Unusual vibration and noise
  - ▶ Unusual overheating and discoloration
- Periodic inspection
  - ▶ Do screws and bolts become loose or rust due to the environment?
- ☞ Tighten or replace them.
  - ▶ Alien substances are clogged in the cooling system?
- ☞ Eliminate them by using compressed air.
  - ▶ Check the rotating condition of the cooling fan, the condition of capacitors and the connections with the magnetic contactor
- ☞ Replace them if there are any abnormalities.

13.5 Parts Replacement

The inverter consists of many electronic parts such as semiconductor devices. The following parts may deteriorate with age because of their structures or physical characteristics, leading to reduced performance or failure of the inverter. For preventive maintenance, the parts must be changed periodically.

Part name	Change period(year)	Description
DC link condenser	4	Exchange
Control smoothing condenser	4	Exchange
Relay	-	Determined after inspection



## 14. COM Option (RS-485)

### 14.1 Introduction

SV-iE5 inverter can be controlled and monitored by the sequence program of the PLC or other master module. Drives or other slave devices may be connected in a multi-drop fashion on the RS-485 network and may be monitored or controlled by a single PLC or PC.

### 14.2 Specifications

● Performance Specifications

Item	Specification
COM method	RS-485
Transmission form	Bus method, Multi drop Link System
Inverter	SV-iE5 series
Converter	RS232 converter
Connectable drives	Max. 16
Transmission distance	Max. 1,200m (within 700m recommended)

● Hardware specification

Item	Specification
Installation	Use S+, S- terminals on control terminal block
Power supply	Use Insulated power from the inverter power supply

● Communication specification

Item	Specification
Communication speed	9,600/4,800/2,400 bps selectable
Control procedure	Asynchronous communication system
COM system	Half duplex system
Character system	Binary
Stop bit length	1 bit / 2bit
CRC check	2 bytes
Parity check	None

### 14.3 Installation

●Connecting the communication line

Connect(wire) to the inverter's (S+), (S-) terminals of the control terminals as shown in the below figure. Use CM terminal on the lower control terminal for COM signal shield ground. COM dedicated terminal is delivered with iE5 COM optional product.

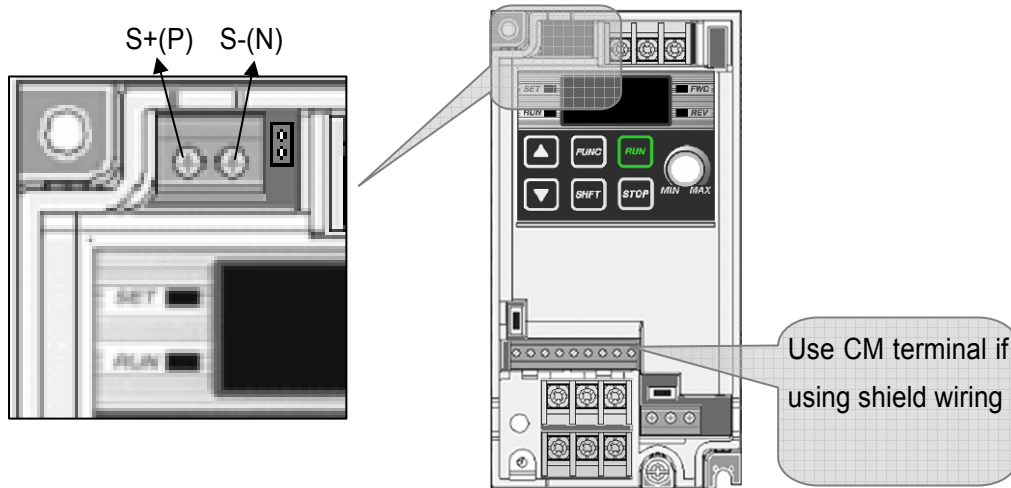

●PC-Inverter connection

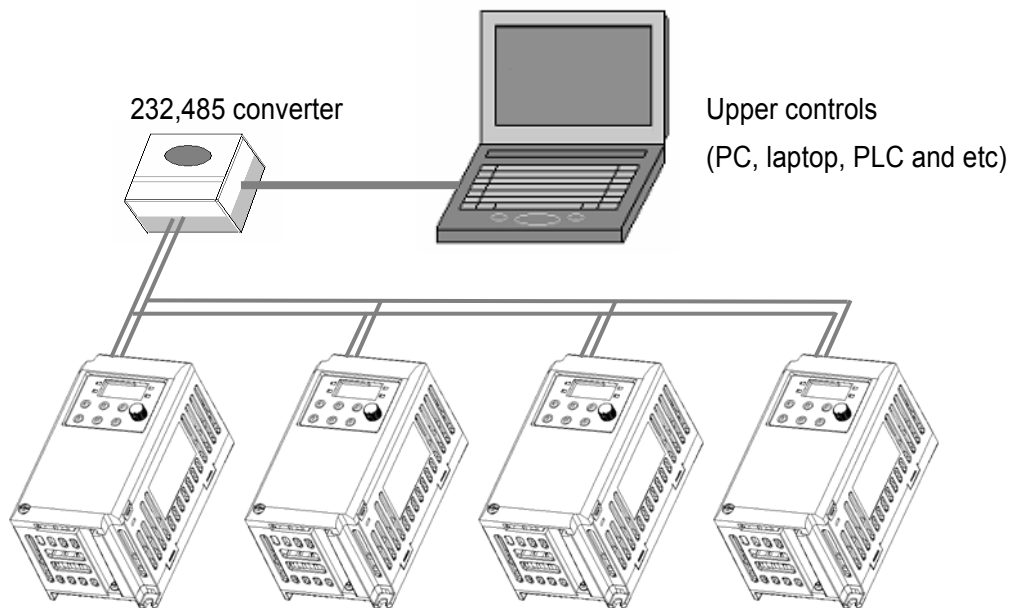

**Note**

The number of drives to be connected is up to 16 drives.  
 The specification of length of communication line is max. 1200m. To ensure stable communication, limit the length below 700m.  
 Short both(S+, S-) of JP1 pin located on the upper PBC of control terminal COM terminal.

● Cable Specification

If communicating by using RS-422 or RS-485 channel, the twisted pair cable for RS-422 should be used considering the communication distance and speed. The specifications of the recommended cable are as follows.

- Product : Low Capacitance Lan Interface Cable
- Spec. : 2P X 22AWG(D/0.254 TA)
- Manufacturer : LS cable
- Type : LIREV-AMESB

Even if using other cables but the above recommended cable, make sure to use cables conforming to the following table.

● Characteristics

Electrical characteristics	Item	Unit	Characteristics	Test condition	
Electrical characteristics	Conductor resistance	Ω/km	59 and lower	Ambient temp.	
	Withstand voltage(DC)	V/1min	Endurable at 500V for 1 minute	In the air	
	Insulation resistance	MΩ-km	1,000 and higher	Ambient temp.	
	Electrostatic cap	Pf/M	45 and lower	1kHz	
	Characteristic impedance	Ω	120 ± 12	10MHz	
Appearance characteristics	Conductor	Core	Pair	2	
		Spec.	AWG	22	
		Structure	NO./mm	1/0.643	
		Dia.	Mm	0.643	
	insulator	Thickness	mm	0.59	
		Dia.	Mm	1.94	

**14.4 Inverter functional code setting**

Once correctly connected, set COM parameters as follows. However, COM speed number should be set according to the system.

● Function

Code	Function	Setting
drv	Run mode	3 (COM)
Frq	Frequency mode	4 (COM)
P 79	Inverter number	1 ~ 250 (set avoiding duplication)
P 80	COM speed	2 (9,600 bps, factory default)
P 81	Run mode when speed command is lost	0 (keep operating with the frequency set before command is lost)



Code	Function	Setting
P 82	Determination time when speed command is lost	1.0 second
P 83	COM waiting time	Set the waiting time until the next TX signal output after receiving RX signal.
P 84	Parity/STOP setting	Set COM parity/stop bit

### 14.5 Operation

Check whether a computer and an inverter are correctly connected.

Turn on the inverter. Do not connect any load to the inverter until it is confirmed that it would be communicated with a computer. Run the inverter in accordance with the inverter run program.

### 14.6 COM Protocol(ModBus-RTU)

Use ModBus-RTU protocol, which is open protocol. It is structured that computer or other host serves as a master while the inverter servers as a slave. The inverter, as a slave, responds to the read/write request of the master

● Supportable function codes

Function	Description	Remarks
h03	Read Hold Register	
h04	Read Input Register	
h06	Preset Single Register	
h10	Preset Multiple Register	

● Exception codes

Exception	Description	Remarks
h01	ILLEGAL FUNCTION	When using other function codes but these supported by the inverter (h03,h04,h06,h10)
h02	ILLEGAL DATA ADDRESS	When parameter address is invalid (not exists)
h03	ILLEGAL DATA VALUE	If function code is h06 or h10(parameter writing command) or when parameter value is not valid (reading only or beyond the range)
h06	SLAVE DEVICE BUSY	Delay
h14	User define	1. Write Disable(Address h0004 value is 0) 2. Read Only or Not Program during Running

**Note**

Common S/W version is displayed in hexadecimal number while the S/W version of parameter is displayed in decimal number.

14.7 Parameter code list

●Common area: Area accessible regardless of inverter models.

Address	Parameter	Scale	Unit	R/W	Data value	
h0000	Inverter model	-	-	R	0 : SV-iS3	7 : SV-iG5
					1 : SV-iG	8 : SV-iC5
					2 : SV-iV	9 : SV-iP5
					3 : SV-iH	A : SV-iG5A
					4 : SV-iS5	D : SV-iE5
					5 :SV-iV5	
h0001	Inverter capacity	-	-	R	FFFF:100W 0000:200W 0001:200W	
h0002	Inverter Input Voltage	-	-	R	0 : 220V class	
h0003	Version	-	-	R	i.e.) Version 1.0 : h0010	
h0004	Parameter Lock	-	-	R/W	0: Lock (default) 1: Unlock	
h0005	Frequency Command	0.01	Hz	R/W	Starting freq. ~ Max. freq.	
h0006	Drive mode	-	-	R/W	BIT 0: Stop	
					BIT 1: Forward Run	
					BIT 2: Reverse Run	
				W	BIT 3: Fault Reset (RESET)	
					BIT 4: Emergency Stop (EST)	
				-	BIT 5, 13~15: Not Used	
				R	BIT 6~7:	
					00: terminal	01: loader
					10: Reserved	11: Com operation
					BIT 8~12: frequency arrival info	
00000: DRV-00	00001: multi-step 1					
00010: multi-step 2	00011: multi-step 3					
00100: UP	00101: Down					
00110: Up/down zero	00111: AI input					
01000: JOG /	01001~					
Loader volume	10010: reserved					
10011: Com operation	10100~					
		11111: reserved				
h0007	Acc Time	0.1	sec	R/W	See Function List	
h0008	Dec Time	0.1	sec	R/W	See Function List	
					h0008	

Address	Parameter	Scale	Unit	R/W	Data value
h0009	Output Current	0.1	A	R	See Function List.
H000A	Output Frequency	0.01	Hz	R	See Function List.
H000B	Output Voltage	0.1	V	R	See Function List.
H000C	DC Link voltage	0.1	V	R	See Function List.
H000D	-	-	-	-	Reserved
h000E	Status of Inverter			R	BIT 0 : Stop
					BIT 1 : Forward running
					BIT 2 : Reverse running
					BIT 3 : Fault (Trip)
					BIT 4 : Accelerating
					BIT 5 : Decelerating
					BIT 6 : speed arrival
					BIT 7 : DC Braking
					BIT 8 : Stopping
					BIT10 : Brake Open
					BIT11 : Forward run command(1)
					BIT12 : Reverse run command(1)
					BIT13 : REM. R/S
					BIT14 : REM. Freq.
h000F	Trip information			R	BIT 0 : OCT
					BIT 1 : OVT
					BIT 2 : EXT-A
					BIT 3 : EST(Emergency Stop)
					BIT 4 : COL
					BIT 5 : GFT(Ground Fault)
					BIT 6 : OHT(Over Heat)
					BIT 7 : GCT(Ground Current Trip)
					BIT 8 : OLT(Overload trip)
					BIT 9 : HW-Diag
					BIT10: EXT-B
					BIT11: EEP(Parameter Write Error)
					BIT12: -
					BIT13: PO(Phase Open)
					BIT14 : IOLT
BIT15: LVT					

Address	Parameter	Scale	Unit	R/W	Data value
h0010	Input terminal status			R	BIT 0 : P1
					BIT 1 : P2
					BIT 2 : P3
					BIT 3 : P4
					BIT 4 : P5
h0011	Output terminal status			R	BIT 0 ~6: Not Used
					BIT 7 : 30AC
h0012	-	-	-	-	Reserved
h0013	-	-	-	-	Reserved
h0014	-	-	-	-	Reserved
h0015	RPM			R	See Function List.

**Note**

The changed value in Common area affects the current setting but returns to the previous setting when power is cycled or Inverter is reset. However, changing value is immediately reflected in other parameter groups even in the case of Reset or Power On/Off.

● DRV group

Address		Code	Parameter	Initial	Max.	Min.
16bit	10bit					
D100	53504	D00	Cmd. Freq	0	Max. Freq.	0
D101	53505	D01	ACC	50	60000	0
D102	53506	D02	DEC	100	60000	0
D103	53507	D03	DRV	1	3	0
D104	53508	D04	FRQ	0	4	0
D105	53509	D05	ST 1	1000	Max. Freq.	0
D106	53510	D06	ST 2	2000	Max. Freq.	0
D107	53511	D07	ST 3	3000	Max. Freq.	0
D108	53512	D08	CUR	-	255	-
D109	53513	D09	RPM	0	1800	0
D10A	53514	D10	DCL	0	65535	0
D10B	53515	D11	USR	0	1	0
D10C	53516	D12	FLT	0	1	0
D10D	53517	D13	DRC	0	1	0

●PROGRAM group

Address		Code	Parameter	Initial	Max.	Min.
16bit	10bit					
D201	53761	P 1	Last Fault1	0	1	0
D202	53762	P 2	Last Fault2	0	1	0
D203	53763	P 3	Last Fault3	0	1	0
D204	53764	P 4	Fault Clear	0	1	0
D205	53765	P 5	Run Prohibit	0	2	0
D206	53766	P 6	ACC Pattern	0	1	0
D207	53767	P 7	DEC Pattern	0	1	0
D208	53768	P 8	Stop Method	0	2	0
D209	53769	P 9	DcBr freq	500	6000	startFreq
D20A	53770	P 10	DcBlk time	10	6000	0
D20B	53771	P 11	DcBr value	50	200	0
D20C	53772	P 12	DcBr time	10	600	0
D20D	53773	P 13	DcSt value	50	200	0
D20E	53774	P 14	DcSt time	0	600	0
D20F	53775	P 15	Jog Freq	1000	Max. Freq.	0
D210	53776	P 16	Max Freq	6000	12000	4000
D211	53777	P 17	Base Freq	6000	12000	3000
D212	53778	P 18	Start Freq	50	1000	10
D213	53779	P 19	Trq Boost	0	1	0
D214	53780	P 20	Fwd Boost	50	150	0
D215	53781	P 21	Rev Boost	50	150	0
D216	53782	P 22	VF Pattern	0	1	0
D217	53783	P 23	OV adj	100	110	40
D218	53784	P 24	OLT select	0	1	0
D219	53785	P 25	OLT level	180	200	50
D21A	53786	P 26	OLT time	600	600	0
D21B	53787	P 27	Stall prev.	0	7	0
D21C	53788	P 28	Stall level	150	150	30
D21D	53789	P 29	Up/Down Save select	0	1	0
D21E	53790	P 30	Up/Down Save Freq.	0	Max. Freq.	0
D21F	53791	P 31	Dwell freq	500	Max. Freq.	startFreq
D220	53792	P 32	Dwell time	0	100	0

Address		Code	Parameter	Initial	Max.	Min.
16bit	10bit					
D221	53793	P 33	Trip select	0	3	0
D222	53794	P 34	Power-on run	0	1	0
D223	53795	P 35	RST restart	0	1	0
D224	53796	P 36	Speed Search	0	50	0
D225	53797	P 37	SS Sup-Curr	100	200	80
D226	53798	P 38	Retry number	0	10	0
D227	53799	P 39	Retry delay	10	600	0
D228	53800	P 40	Motor select	0	2	0
D229	53801	P 41	Pole number	4	12	2
D22A	53802	P 42	Rated-Slip freq.	200	1000	0
D22B	53803	P 43	Rated-Curr	10	255	0
D22C	53804	P 44	Noload-Curr	5	255	0
D22D	53805	P 45	Carrier freq	30	100	10
D22E	53806	P 46	Control Mode	0	2	0
D22F	53807	P 47	PI P-gain	3000	9999	0
D230	53808	P 48	PI I-gain	100	3200	10
D232	53810	P 50	PI F-gain	0	9999	0
D233	53811	P 51	PI output freq. H limit	6000	Max. Freq.	PI output freq.L limit
D234	53812	P 52	PI output freq. L limit	50	PI output freq. H limit	startFreq.
D235	53813	P 53	PowerOn disp	0	15	0
D236	53814	P 54	Rpm disp Gain	100	1000	1
D237	53815	P 55	AI input filter cont	10	9999	0
D238	53816	P 56	AI min. Input(v/i)	0	AI max. inupt	0
D239	53817	P 57	AI min. input freq.	0	Max. Freq.	0
D23A	53818	P 58	AI max. Input(v/i)	1000	1000	AI min. input
D23B	53819	P 59	AI max. input freq.	6000	Max. Freq.	0
D23C	53820	P 60	Volume input filter cont	10	9999	0
D23D	53821	P 61	Volume min. input	0	Vol. max. input	0
D23E	53822	P 62	Volume input min. freq.	0	Max. Freq.	0
D23F	53823	P 63	Volume max. input	1000	1000	Vol. min. input
D240	53824	P 64	Volume input max. freq.	6000	Max. Freq.	0
D241	53825	P 65	Anal speed command lost criteria	0	2	0
D242	53826	P 66	P1 define	0	24	0

Address		Code	Parameter	Initial	Max.	Min.
16bit	10bit					
D243	53827	P 67	P2 define	1	24	0
D244	53828	P 68	P3 define	2	24	0
D245	53829	P 69	P4 define	3	24	0
D246	53830	P 70	P5 define	4	24	0
D247	53831	P 71	Input T/M status disp	0	31	0
D248	53832	P 72	MF input T/M filter cont.	3	20	1
D249	53833	P 73	Anal. Output item select	0	3	0
D24A	53834	P 74	Anal. Output level adj.	100	200	10
D24B	53835	P 75	Det. Freq.	3000	Max. Freq.	0
D24C	53836	P 76	Det. Freq. bandwidth	1000	Max. Freq.	0
D24D	53837	P 77	Relay func. select	17	17	0
D24E	53838	P 78	Fault output select.	2	7	0
D24F	53839	P 79	Inv No.	1	250	1
D250	53840	P 80	Baud rate	2	2	0
D251	53841	P 81	Lost command	0	2	0
D252	53842	P 82	Determination time of freq. input lost	10	1200	1
D253	53843	P 83	COM speed set	5	100	2
D254	53844	P 84	Parity/Stop Bit set	0	3	0
D255	53845	P 85	Para Init	0	2	0
D256	53846	P 86	Password set	0	FFFF	0
D257	53847	P 87	Para. Lock	0	65535	0
D258	53848	P 88	S/W Version	1	65535	0

### 14.8 Troubleshooting

Refer to Troubleshooting when RS -485 communication error occurs

- If communication is not connected

Check points	Corrective measures
Is the power provided to the converter?	Provide electric power to the converter.
Are the connections between converter and computer correct?	Refer to converter manual.
Does master start to communicate?	Start communication
Is baud rate of computer and inverter correctly set?	Set the correct value in accordance with“14.3 Installation”.
<sup>1)</sup> Is the data format of user program right?	Revise User Program.
Is the connection between converter and communication card right?	Check for GF the correct wiring in accordance with“14.3 Installation”.

<sup>1)</sup> User program refers to the embedded program for MCU or S/W programmed by a user.





## 15. Specifications

### 15.1 Technical data

#### ● Input & output ratings

Type : SV xxx iE5 – x		001-1	002-1	004-1	001-2	002-2	004-2
<sup>1)</sup> Motor	[HP]	1/8	1/4	1/2	1/8	1/4	1/2
	[kW]	0.1	0.2	0.4	0.1	0.2	0.4
Output ratings	<sup>2)</sup> Capacity[kVA]	0.3	0.6	0.95	0.3	0.6	1.14
	Current [A]	0.8	1.4	2.5	0.8	1.6	3.0
	Output frequency	0 ~ 200 [Hz]					
	Voltage [V]	<sup>3)</sup> 3phase 200 ~ 230V					
Input ratings	Voltage [V]	1phase 200 ~ 230 VAC (±10%)			3phase 200~230 VAC (±10%)		
	Frequency	50 ~ 60 [Hz] (±5%)					
	Current[A]	2.0	3.5	5.5	1.2	2.0	3.5

#### ● Control

Control method	v/f
Frequency setting resolution	Digital command : 0.01Hz Analog command : 0.1Hz (max. fre : 60Hz)
Frequency accuracy	Digital command: 0.01% of Max output frequency Analog command: 0.1% of Max output frequency
v/f pattern	Linear, Squared, v/f
Overload capacity	150% per min.
Torque boost	Manual/Auto torque boost

<sup>1)</sup> Motor shows the max. capacity assuming that 4 poles standard motor is used.

<sup>2)</sup> Ratings are based on 220V.

<sup>3)</sup> Max. output voltage may not be over the power voltage. Output voltage may be set temporarily lower than the power voltage.

● Operation

Operation mode		Select one of loader/terminal/COM operation(optional)	
Frequency setting		Analogue: 0 ~ 10[V], 0 ~ 20[mA], loader volume Digital: loader	
Operation features		PID, up-down, 3-wire	
Input	Multi-function terminal P1, P2, P3, P4, P5	NPN / PNP selectable(see page 3-5)	
		Functions: FWD/REV RUN, Emergency stop, Fault reset, Jog operation, Multi-step Frequency-High & Low, Frequency UP/Down, 3-wire operation, External trip A & B, PID-Inverter (v/f) operation bypass, Analog Hold, Accel/Decel stop, Up/Down Save Freq.	
	Multi-function relay	Fault output and inverter status output	Less than (N.O., N.C.) AC250V 0.3A Less than DC 30V 1A
Analog output		0 ~ 10 Vdc (less than 10mA) : frequency, current, voltage, DC voltage selectable	

● Protective function

Trip	Over Voltage, low voltage, over current, ground fault detection, inverter overload, overload trip, inverter overheat, condenser overload, output phase loss, overload protection, frequency command loss, hardware fault.
Alarm	Stall prevention
Momentary power loss	Below 15 msec: Continuous operation (should be within rated input voltage, rated output power.) Above 15 msec: Auto restart enable

● Structure & Environment

Cooling	Natural cooling
Protection type	Open(IP 20)
Ambient temperature	-10°C ~ 40°C
Storage temperature	-20°C ~ 65°C
Ambient humidity	Less than 90% RH(no condensation)
Altitude, vibration	Below 1,000m, below 5.9m/sec <sup>2</sup> (0.6G)
Environmental conditions	Protected from corrosive gas, combustible gas, oil mist or dust

## WARRANTY

<b>Maker</b>	LS Industrial Systems Co.,Ltd	<b>Installation(start-up) date</b>	
<b>Model No.</b>	SV-iE5	<b>Warranty period</b>	
<b>Customer info</b>	<b>Name</b>		
	<b>Address</b>		
	<b>Tel.</b>		
<b>Sales office</b>	<b>Name</b>		
	<b>Address</b>		
	<b>Tel.</b>		

**Note**

This product has been manufactured through the strict QC control and inspection of LS Industrial Systems. Warranty period is 12 months after installation or 18 months after manufactured when the installation date is unidentified. However, the guarantee term may vary on the sales term.

● In-warranty service information

- ▶ If the defective part has been identified under normal and proper use within the guarantee term, contact your local authorized LS distributor or LS Service center.

● Out-of-warranty service information

- ▶ The guarantee will not apply in the following cases.
- ▶ Troubles are attributable to a user's intentional negligence or carelessness
- ▶ Damage was caused by abnormal voltage and peripheral devices' malfunction (failure)
- ▶ Damage was caused by natural disasters(earthquake, fire, flooding, lightning and etc)
- ▶ When LS nameplate is not attached

## Manual Revision History

No.	Revision	Changes	Version. No	Remarks
1	Jan. 2007	First edition	1.10	



● Sustainable Management

LS Industrial System Co.,Ltd take the highest priority on sustainable management and do our best to preserve the environment of the earth.



● Disposal Recommendation

LS Inverter is intended and designed to preserve the environment. To dispose of it, iron, aluminum, copper, and synthetic resin(product cover) may be separated and reused.



LS values every single customer.  
Quality and service come first at LSIS.  
Always at your service, standing for our customers.

[www.lsis.biz](http://www.lsis.biz)

**LS** Industrial Systems

10310000756

■ **HEAD OFFICE**

Yonse Jaedan Severance Bldg. 84-11 5 ga, Namdaemun-ro,  
Jung-gu Seoul 100-753, Korea <http://eng.lsis.biz>  
Tel. (82-2)2034-4643~4649 Fax.(82-2)2034-4879, 2034-4885

■ **LS Industrial Systems Tokyo Office >> Japan**

Address: 16F, Higashi-Kan, Akasaka Twin Towers 17- 22,  
2-chome, Akasaka, Minato-ku, Tokyo 107-8470, Japan  
Tel: 81-3-3582-9128 Fax: 81-3-3582-2667

e-mail: [jschuna@lsis.biz](mailto:jschuna@lsis.biz)

■ **LS Industrial Systems Dubai Rep. Office >> UAE**

Address: P.O.BOX-114216, API World Tower, 303B, Sheikh  
Zayed road, Dubai, UAE. e-mail: [hwyim@lsis.biz](mailto:hwyim@lsis.biz)  
Tel: 971-4-3328289 Fax: 971-4-3329444

■ **LS-VINA Industrial Systems Co., Ltd. >> Vietnam**

Address: LSIS VINA Congty che tao may dien Viet-Hung  
Dong Anh Hanoi, Vietnam e-mail: [srjo@hn.vnn.vn](mailto:srjo@hn.vnn.vn)  
Tel: 84-4-882-0222 Fax: 84-4-882-0220

■ **LS Industrial Systems Hanoi Office >> Vietnam**

Address: Room C21, 5th Floor, Horison Hotel, 40 Cat Linh,  
Hanoi, Vietnam  
Tel: 84-4-736-6270/1 Fax: 84-4-736-6269

■ **Dalian LS Industrial Systems co., Ltd. >> China**

Address: No. 15 Liaohexi 3 Road, economic and technical  
development zone, Dalian, China e-mail: [lixk@lgis.com.cn](mailto:lixk@lgis.com.cn)  
Tel: 86-411-8273-7777 Fax: 86-411-8730-7560

■ **LS Industrial Systems (Shanghai) Co., Ltd. >> China**

Address: Room E-G, 12th Floor Huamin Empire Plaza,  
No. 726, West Yan'an Road, Shanghai, China  
Tel: 86-21-5237-9977

■ **LS Industrial Systems(Wuxi) Co., Ltd. >> China**

Address: 102-A National High & New Tech Industrial  
Development Area, Wuxi, Jiangsu, China e-mail: [Xugh@lgis.com.cn](mailto:Xugh@lgis.com.cn)  
Tel: 86-510-534-6666 Fax: 86-510-522-4078

■ **LS Industrial Systems Beijing Office >> China**

Address: B-tower 17th Floor, Beijing Global Trade Center building,  
No. 36, BeiSanHuanDong-Lu, DongCheng-District, Beijing, China  
Tel: 86-10-5825-6025

■ **LS Industrial Systems Guangzhou Office >> China**

Address: Room 1403, 14F, New Poly Tower, 2 Zhongshan Liu  
Rad, Guangzhou, China e-mail: [zhangch@lgis.com.cn](mailto:zhangch@lgis.com.cn)  
Tel: 86-20-8326-6754 Fax: 86-20-8326-6287

■ **LS Industrial Systems Chengdu Office >> China**

Address: Room 2907, Zhong Yin B/D, No. 35, Renminzhong(2)-  
Road, Chengdu, China e-mail: [hongkonk@vip.163.com](mailto:hongkonk@vip.163.com)  
Tel: 86-28-8612-9151 Fax: 86-28-8612-9236

■ **LS Industrial Systems Qingdao Office >> China**

Address: 12th Floor, Guodong building, No52 Jindun Road,  
Chengdu, China e-mail: [bellkuk@hanmail.net](mailto:bellkuk@hanmail.net)  
Tel: 86-532-580-2539 Fax: 86-532-583-3793

※ LS Industrial Systems constantly endeavors to improve its product so that  
Information in this manual is subject to change without notice.

**SV-iE5 / 2007.1**