

The right choice for the ultimate yield!

LS ELECTRIC strives to maximize your profits in gratitude for choosing us as your partner.

# RAPIEnet+ Option Module

LSLV-G100 series

User's Manual

[RAPIEnet, EtherNet/IP, Modbus TCP Protocol]

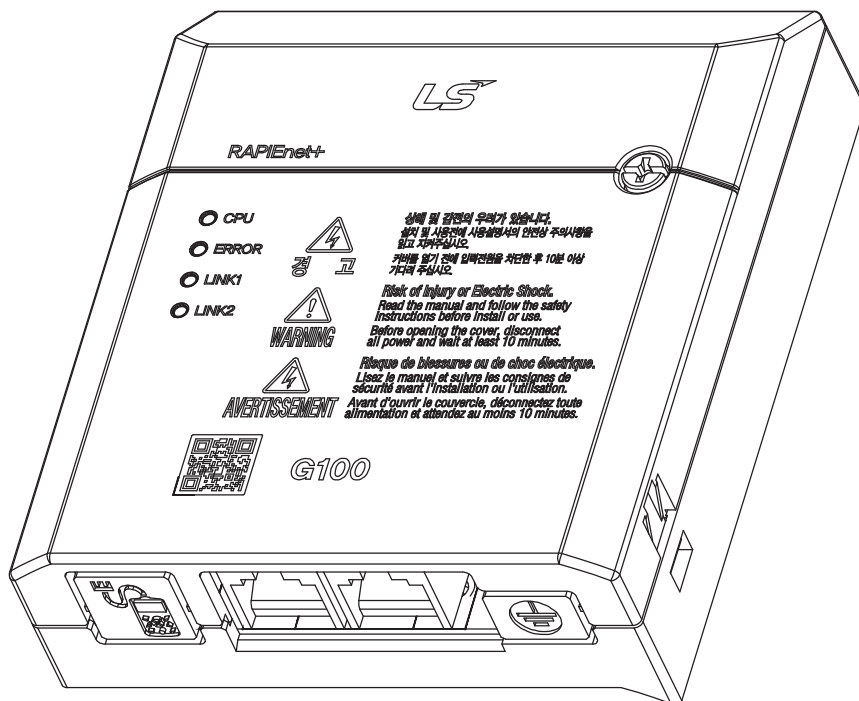

## Safety Instructions

- Use this board after read Safety Instruction of this manual carefully before using and follow the instructions exactly.
- Please hand this user manual to end user and trouble shooting manager
- After read this manual, keep it at handy for future reference.
- 사용 전에 '안전상의 주의사항'을 반드시 읽고 정확하게 사용하여 주십시오.
- 본 설명서는 제품을 사용하는 사람이 항상 볼 수 있는 곳에 잘 보관하십시오.

**LS**ELECTRIC

Before using the product

Thank you for purchasing the G100 RAPIEnet+ communication board.

# Safety Information

- Always follow safety instructions to prevent accidents and potentially hazardous situations.
- Safety precautions are classified into “WARNING” and “CAUTION,” and their meanings are as follows:

## Warning

Indicates a potentially hazardous situation which, if not avoided, may cause death or serious injury.

## Caution

Indicates a potentially hazardous situation, which, if not avoided, may cause minor injury or damage to the product.

- Symbols used in this document and on the product indicate the following.

 Read and follow the instructions carefully to avoid dangerous situations.

 Presence of "dangerous voltage" inside the product that may cause harm or electric shock.

- Keep the operating instructions handy for quick reference.
- Read the operating instructions carefully to fully understand the functions of the LSLV-G100 series inverters and use them properly.

## Caution

- **Be careful not to damage the CMOS elements on the communication board.**  
Static charge may cause malfunctioning of the product.
- **Turn off the inverter before connecting communication cables.**  
Otherwise, the module may be damaged or a communication error may result.
- **Correctly align the communication board to the installation connector for installation and ensure that it is firmly connected to the inverter.**  
Otherwise, the module may be damaged or a communication error may result.
- **Check the parameter units when configuring the parameter values.**  
Otherwise, a communication error may occur.

# Table of Contents

<b>1 Overview</b> .....	<b>1</b>
<b>2 RAPIEnet+ technical specifications</b> .....	<b>2</b>
<b>3 Package components</b> .....	<b>3</b>
<b>4 Device type for the G100 RAPIEnet+ communication board</b> .....	<b>3</b>
<b>5 G100 RAPIEnet+ communication board layout and installation</b> .....	<b>3</b>
5.1 External layout .....	3
5.2 Installing the G100 RAPIEnet+ communication board .....	4
<b>6 Network connection</b> .....	<b>5</b>
6.1 Network connection cable wiring .....	5
6.2 Communication cable connector .....	5
<b>7 Network cable specifications</b> .....	<b>6</b>
7.1 Frequency band .....	6
7.2 Twisted pair cable types .....	6
<b>8 Inverter communication address</b> .....	<b>7</b>
<b>9 Keypad parameters for RAPIEnet+ communication board</b> .....	<b>8</b>
<b>10 Description of keypad parameters related to RAPIEnet+ communication board</b> .....	<b>11</b>
10.1 Description of keypad parameters (simplified) .....	11
10.2 Operation Group .....	13
10.3 CM Group .....	13
10.4 PRT group (Lost Command).....	17

<b>11 Services with LS ELECTRIC products .....</b>	<b>18</b>
11.1 Introduction .....	18
11.2 Smart scaling (LS ELECTRIC master module: XGL-EFMxB V8.0 or later) .....	18
11.2.1 Configuring the XG5000 program for the PLC .....	20
11.2.2 Configuring the master module.....	21
11.2.3 Network device settings.....	21
11.2.4 Input/Output parameter settings .....	22
11.2.5 Diagnostic parameter settings .....	22
11.2.6 Network device connections .....	23
11.2.7 Service status .....	23
11.3 LED Indications and troubleshooting.....	25
<b>12 Services with LS ELECTRIC products or other manufacturer's products .....</b>	<b>27</b>
12.1 Introduction .....	27
12.2 EtherNet/IP .....	28
12.2.1 Basic protocol structure .....	28
12.2.2 Implicit message .....	29
12.2.3 Explicit messages .....	35
12.2.4 Supported objects .....	36
12.3 Modbus TCP frame.....	43
12.3.1 Modbus TCP frame structure.....	43
12.3.2 Function codes.....	44
12.3.3 Exception (Except) frame .....	46
12.4 LED Indications and troubleshooting.....	47

# 1 Overview

The RAPIEnet+ communication board allows the LSLV-G100 inverter to connect to an EtherNet or RAPIEnet network that is compliant with international standards, Type 21 of IEC 61158 and RRP of IEC 62439. The RAPIEnet+ communication board supports three protocols: RAPIEnet, EtherNet/IP, and Modbus TCP.

By utilizing the 100 Mbps auto negotiation feature, the RAPIEnet+ communication board provides real-time network communication without collisions and allows for controlling and monitoring of the inverter via PLC sequence programs or a Profibus master module.

With simple network cable wiring, installation times can be reduced and maintenance becomes easier.

(When accessing a RAPIEnet v2.0 network with XG5000, LS ELECTRIC network master module XGL-EFMxB V8.0 or later is required.)

\*\* You can download the user manual ("Manual\_XGT\_FEnet") at: <https://www.lselectric.co.kr>

## Ref.

What is "RAPIEnet+"?

RAPIEnet+ is a hybrid networking solution that incorporates RAPIEnet, LS ELECTRIC's real-time industrial EtherNet based on international standards, with highly compatible Modbus TCP and EtherNet/IP network technologies. This highly efficient industrial EtherNet by LS ELECTRIC allows for integration of various future technologies required for factory automation, such as the IoT.

## 2 RAPIEnet+ technical specifications

Items	Description	
Communication Protocol	RAPIEnet, EtherNet/IP, Modbus TCP	
Communication speed	100Mbps	
Communication type	Auto negotiation	
Communication range	100 m (twisted pair)	
Service	Smart scaling	Up to 8 words
Max. number of stations	64 stations	
Topology	Line/Ring topology	
Communication range	100 m (twisted pair)	
Recommended cable	UTP, FTP, STP	

\* The G100 RAPIEnet+ communication board supports all the features of the G100 EtherNet communication board.

### 3 Package components

The product package contains: RAPIEnet+ communication board (1 ea), body connection cable (1 ea), and RAPIEnet+ communication board User Manual.

### 4 Device type for the G100 RAPIEnet+ communication board

Device type: CENT

### 5 G100 RAPIEnet+ communication board layout and installation

#### 5.1 External layout

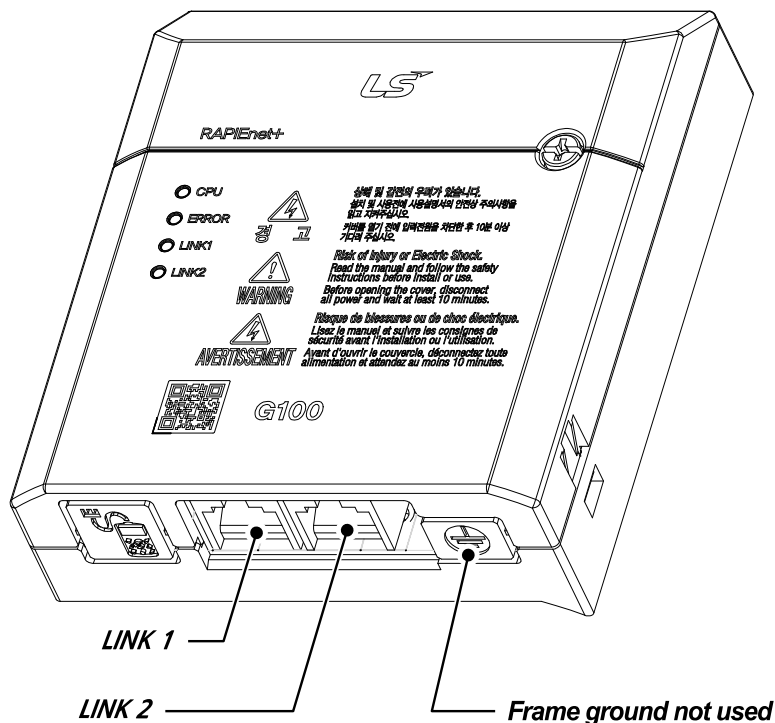



## 5.2 Installing the G100 RAPIEnet+ communication board

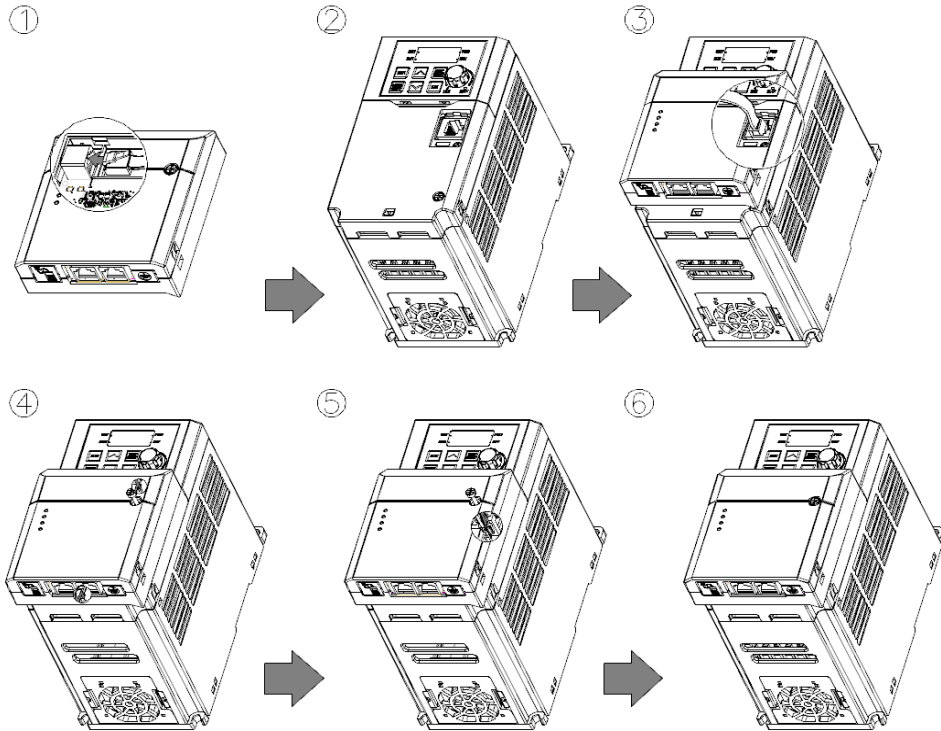

- 1 Connect the included RJ-45 cable to G100 RAPIEnet + communication board.
- 2 Remove the front cover from the G100 inverter.
- 3 Connect the G100 RAPIEnet + communication module to the G100 inverter using the included RJ-45 network cable.
- 4 Hook up the G100 RAPIEnet+ communication module to the installation slot on the inverter.
- 5 Install the fixing bolt provided with the G100 RAPIEnet+ communication module using an appropriate tool.
- 6 The G100 inverter and the G100 RAPIEnet + communication module have been connected.

### Warning

- Do not install or remove the RAPIEnet+ communication board to or from the G100 inverter while the inverter is turned on.
- Ensure that the electric charge in the capacitors inside the inverter is completely discharged before installing or uninstalling the RAPIEnet+ communication board.
- Ensure that the RJ-45 cable is firmly fixed to the inverter and the option board.
- Frame ground (FG) should not be used on the G100 RAPIEnet+ communication option boards.

## 6 Network connection

### 6.1 Network connection cable wiring

Pin no.	Signal	Description	Cable color
1	TX+	Data transmission (+)	White/Yellow
2	TX-	Data transmission (-)	Yellow
3	RX+	Data reception (+)	White/Green
4	NONE	Not used	Blue
5	NONE	Not used	White/Blue
6	RX-	Data reception (-)	Green
7	NONE	Not used	White/Brown
8	NONE	Not used	Brown

### 6.2 Communication cable connector

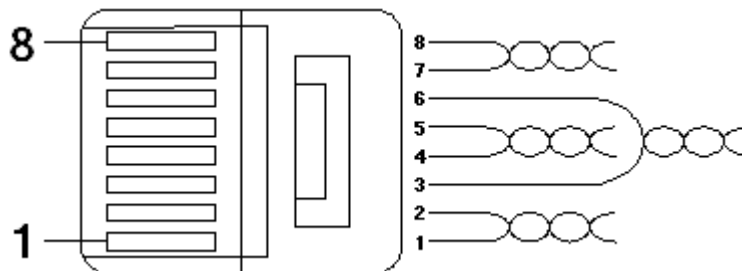

\*\* The cables connected to pin 1 and pin 2 must be twisted in a pair.

\*\* The cables connected to pin 3 and pin 6 must be twisted in a pair.

## 7 Network cable specifications

### 7.1 Frequency band

There are five types of UTP cable specifications according to different applications, from category 1 through category 5. Category 5 network cables are required for utilizing the RAPIEnet+ communication board.

Category 5 network cables support a frequency band up to 100 MHz, with up to 60 MHz channel performance and up to 100 Mbps data transmission speed.

### 7.2 Twisted pair cable types

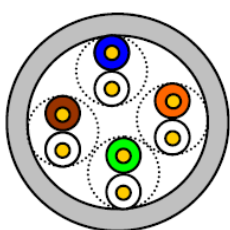

UTP

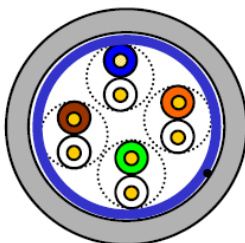

FTP

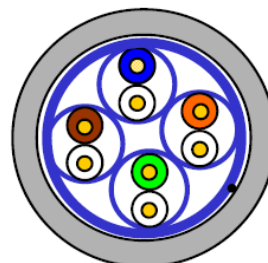

STP

Category	Description	Specifications/Usage
UTP (U.UTP)	Unshielded Twisted Pair cable for high speed signals	200 MHz max. Voice + Data + Low quality video signals
FTP (S.UTP)	Single insulation for the cable core * Insulation material: AL / Plastic complex foil or copper braid	100 MHz max. Protection against EMI, electrically stable Voice + Data + Low quality video signals
STP (S.STP)	Dual insulation for the pair and the cable core * Material for cable pair insulation: AL/Plastic complex foil * Material for cable core insulation: AL / Plastic complex foil or copper braid	500MHz max. Voice + Data + Video signals Replaces 75Ω coaxial cable

---

## 8 Inverter communication address

Refer to “Chapter 11. Communication features” of the “G100 User Manual” for details.

\*\* You can download the “G100 User Manual” at: <https://www.lselectric.co.kr>

## 9 Keypad parameters for RAPIenet+ communication board

The following table lists the inverter parameters related to RAPIenet, EtherNet/IP, and Modbus TCP communication features. Application types for each parameter is specified in the “Protocol” column: R (RAPIenet), E (EtherNet/IP), or M (Modbus TCP).

Set drv parameter (Cmd Source) to “4 (Fieldbus)” using the keypad to operate the G100 inverter via the RAPIenet+ communication board.

Set Freq parameter (Frq Ref Src) to “8 (Fieldbus)” using the keypad to provide frequency reference via the RAPIenet+ communication board.

Keypad parameters related to G100 RAPIenet+ communication board					
Code No.	Parameter Name	Initial Value	Range	Description	Protocol
drv	Cmd Source	1	0 – 4	4: Set to “Field Bus.”	R/E/M
Frq	Freq Ref Src	0	0 – 8	8: Set to “Field Bus.”	R/E/M
CM-06	FBus S/W Ver	-	-	Indicates the version of the communication board installed.	R/E/M
CM-07	FBus ID	10	0 – 63	Set the station number of the RAPIenet+ communication board.	R/E
CM-09	FBus Led			Displays the on/off status of the LED indicators on the RAPIenet+ communication board.	R/E/M
CM-10	Opt Parameter1	192	0 – 255	Sets the IP address.	R/E/M
CM-11	Opt Parameter2	168	0 – 255	* To connect to the network via the RAPIenet protocol after setting CM-25 to “2 (RAPIenet Enable),” set CM-13 to “100 + CM-07.”	
CM-12	Opt Parameter3	1	0 – 255		
CM-13	Opt Parameter4	101	0 – 255		
CM-14	Opt Parameter5	255	0 – 255		Set the subnet mask.
CM-15	Opt Parameter6	255	0 – 255		
CM-16	Opt Parameter7	255	0 – 255		
CM-17	Opt Parameter8	0	0 – 255		
CM-18	Opt Parameter9	192	0 – 255	Sets the Gateway address.	R/E/M
CM-19	Opt Parameter 10	168	0 – 255		
CM-20	Opt Parameter 11	1	0 – 255		
CM-21	Opt Parameter 12	10	0 – 255		
CM-22	Opt Parameter 13	0	0	Set the network communication speed. (fixed to 100 Mbps Auto)	R/E/M
CM-23	Opt Parameter 14	1	0 – 11	CIP Input Instance	R/E

## Keypad parameters for RAPIenet+ communication board

Keypad parameters related to G100 RAPIenet+ communication board					
CM-24	Opt Parameter 15	1	0 – 11	CIP Output Instance	R/E
CM-25	Opt Parameter 16	2	0 – 2	2: RAPIenet Enable 0: RAPIenet Disable	R/E

### Ref.

After making changes to parameter CM-07 and parameters CM-10 – 25, you must set CM-94 (Comm-Update) to “1 (Yes)” to save the changes. (If CM-94 [Comm-Update] has not been set after making the parameter changes, the LED indicator will flash in red at 2-second intervals to warn the user.)

Keypad parameters related to G100 RAPIenet+ communication board					
Code No.	Parameter Name	Initial Value	Range	Description	Protocol
CM-30	Para Status Num	3	0 – 8	Automatically set according to the CIP Input Instance.	R/E
CM-31	Para Status-1	000A	0x0000 -0xFFFF	Sets up the inverter data address to be read by the client. (Hex.)	R/E
CM-32	Para Status-2	000D	0x0000 -0xFFFF	Sets up the inverter data address to be read by the client. (Hex.)	R/E
CM-33	Para Status-3	000F	0x0000 -0xFFFF	Sets up the inverter data address to be read by the client. (Hex.)	R/E
CM-34	Para Status-4	-	0x0000 -0xFFFF	Sets up the inverter data address to be read by the client. (Hex.)	R/E
CM-35	Para Status-5	-	0x0000 -0xFFFF	Sets up the inverter data address to be read by the client. (Hex.)	R/E
CM-36	Para Status-6	-	0x0000 -0xFFFF	Sets up the inverter data address to be read by the client. (Hex.)	R/E
CM-37	Para Status-7	-	0x0000 -0xFFFF	Sets up the inverter data address to be read by the client. (Hex.)	R/E
CM-38	Para Status-8	-	0x0000 -0xFFFF	Sets up the inverter data address to be read by the client. (Hex.)	R/E
CM-50	Para Ctrl Num	2	0 – 8	Automatically set according	R/E

## Keypad parameters for RAPIenet+ communication board

Keypad parameters related to G100 RAPIenet+ communication board					
				to the CIP Output Instance.	
CM-51	Para Control-1	0005	0x0000 -0xFFFF	Sets up the client's command address. (Hex.)	R/E
CM-52	Para Control-2	0006	0x0000 -0xFFFF	Sets up the client's command address. (Hex.)	R/E
CM-53	Para Control-3	-	0x0000 -0xFFFF	Sets up the client's command address. (Hex.)	R/E
CM-54	Para Control-4	-	0x0000 -0xFFFF	Sets up the client's command address. (Hex.)	R/E
CM-55	Para Control-5	-	0x0000 -0xFFFF	Sets up the client's command address. (Hex.)	R/E
CM-56	Para Control-6	-	0x0000 -0xFFFF	Sets up the client's command address. (Hex.)	R/E
CM-57	Para Control-7	-	0x0000 -0xFFFF	Sets up the client's command address. (Hex.)	R/E
CM-58	Para Control-8	-	0x0000 -0xFFFF	Sets up the client's command address. (Hex.)	R/E
CM-94	Comm Update	0	0: NO 1: YES	Update keypad parameters related to network communication.	R/E/M
Pr-12	Lost Cmd Mode	None	0: None 1: Free-Run 2: Dec 3: Hold Input 4: Hold Output 5: Lost Preset	Set the inverter operation for when a Lost Command has occurred. (Note1)	R/E/M
Pr-13	Lost Cmd Time	1.0	0.1 – 120	Lost Command trigger time	R/E/M
Pr-14	Lost Preset F	0.00	0.05 – 60.00	Sets the Lost Preset speed	R/E/M

(Note1) Lost Command Mode

Set value	Function
"None"	Maintains the previous status.
"Free-Run"	Lost Command Trip occurs and a free run stop is made.
"Dec"	Lost Command Trip occurs and a deceleration stop is made.
"Hold Input"	Lost Command Warning occurs and the inverter operates with the previous speed reference.
"Hold Output"	Lost Command Warning occurs and the inverter operates with the previous running speed.
"Lost Preset"	Lost Command Warning occurs and the inverter operates with speed reference set at PRT-14.

# 10 Description of keypad parameters related to RAPIEnet+ communication board

## 10.1 Description of keypad parameters (simplified)

The following table lists the simplified information of keypad parameters. The detailed information is provided in the parameter group section.

Code	Parameter Name	Description
drv	Cmd Source	Command Source
Frq	Freq Ref Src	Frequency reference source
CM	06 FBus S/W Ver	Communication option S/W version
	07 FBus ID	Station ID of the communication board (communication board ID)
	09 FBus Led	Information about LED indicators on the communication board
	10 opt para-1	Enter the 1st decimal number of the IP address.
	11 opt para-2	Enter the 2nd decimal number of the IP address.
	12 opt para-3	Enter the 3rd decimal number of the IP address.
	13 opt para-4	Enter the 4th decimal number of the IP address.
	14 opt para-5	Enter the 1st decimal number of the subnet address.
	15 opt para-6	Enter the 2nd decimal number of the subnet address.
	16 opt para-7	Enter the 3rd decimal number of the subnet address.
	17 opt para-8	Enter the 4th decimal number of the subnet address.
	18 opt para-9	Enter the 1st decimal number of the gateway address.
	19 opt para-10	Enter the 2nd decimal number of the gateway address.
	20 opt para-11	Enter the 3rd decimal number of the gateway address.
21 opt para-12	Enter the 4th decimal number of the gateway address.	
22 opt para-13	Network communication speed (0 fixed, automatically set to 100 Mbps)	
23 opt para-14	RAPIEnet: Set the Input Parameter Size EtherNet/IP: Set the Input Instance	



## Description of keypad parameters related to RAPIenet+ communication board

Code	Parameter Name	Description
	24 opt para-15	RAPIenet: Set Output Parameter Size EtherNet/IP: Set Output Instance
	25 opt para-16	Enable or disable RAPIenet 2: Enable RAPIenet (Default) 0: RAPIenet Disable
	30 ParaStatus Num	Displays the number of transmitted data
	31 Para Status-1	Set address 1 for storing the transmitted data.
	32 Para Status-2	Set address 2 for storing the transmitted data.
	33 Para Status-3	Set address 3 for storing the transmitted data.
	34 Para Status-4	Set address 4 for storing the transmitted data.
	35 Para Status-5	Set address 5 for storing the transmitted data.
	36 Para Status-6	Set address 6 for storing the transmitted data.
	37 Para Status-7	Set address 7 for storing the transmitted data.
	38 Para Status-8	Set address 8 for storing the transmitted data.
	50 Para Ctrl Num	Displays the number of received data
	51 Para Control-1	Set address 1 for storing the received data.
	52 Para Control-2	Set address 2 for storing the received data.
	53 Para Control-3	Set address 3 for storing the received data.
	54 Para Control-4	Set address 4 for storing the received data.
	55 Para Control-5	Set address 5 for storing the received data.
	56 Para Control-6	Set address 6 for storing the received data.
	57 Para Control-7	Set address 7 for storing the received data.
	58 Para Control-8	Set address 8 for storing the received data.
	94 Comm Update	Reflect the network parameter changes.
Pr	12 Lost Cmd Mode	Select operation mode for a lost command.
	13 Lost Cmd Time	Set the decision time for a lost command.
	14 Lost Preset F	Set the start frequency for a lost command.

## 10.2 Operation Group

### ① [drv] Cmd Source: Command Source

Select the command source for the G100 inverter. Set to "4 (Field Bus)" to set the RAPIEnet communication board as the command source and provide commands via network.

### ② [Frq] Freq Ref Src: Frequency reference source

Select the frequency command source for the G100 inverter. Set to "8 (Field Bus)" to set the RAPIEnet communication board as the frequency command source and provide frequency commands via network.

## 10.3 CM Group

### ① [CM-06] FBus S/W Ver: Communication option S/W version

Automatically indicates the version of the communication board installed to the G100 inverter.

### ② [CM-07] FBus ID: Station ID of the communication board (communication board ID)

R: Set the station ID for the G100 RAPIEnet+ communication board. A total of 64 station IDs are available from 0 to 63. (The station ID must be set before you can configure network communication using the RAPIEnet protocol.)  
When setting the station ID, be careful not to use a station ID that is not already occupied by the PLC system or other network devices.  
After making setting changes, you must set CM-94 (Comm Update) to "1 (Yes)" before the changes can take effect.

### ③ [CM-09] FBus Led: Information about LED indicators on the communication board

Displays on the Keypad the status of the LED indicators on the G100 RAPIEnet+ communication board. Refer to sections "11.3/12.4 LED indications and troubleshooting."

Example of the COM-09 (FBus LED) indication

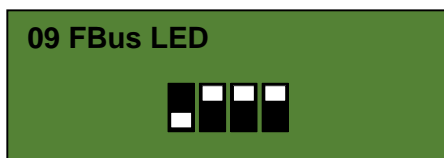

LINK1	LINK2	ERROR	CPU
LED is OFF	LED is ON	LED is ON	LED is ON

④ **[CM-22] opt para-13: Set the network communication speed. (100 Mbps, Auto Negotiation)**

The EtherNet speed parameter is fixed at "0" by default for 100 Mbps communication speed.

G100G100

⑤ **[CM-23] opt para-14: Transmission data setting**

Used to monitor one of the smart scaling transmission data of the G100 RAPIEnet+ communication board. You can select one of the data transmission addresses from CM31 to CM38 for monitoring.

You can set "opt para-14 (smart scaling transmission data index)" to between "0" and "11." Refer to the following table for the description of the "opt para-14" settings.

The "opt para-14 (smart scaling transmission data index)" setting cannot be written while the inverter is operating. Stop inverter operation before making changes to the setting.

This parameter setting is also required for a service via EtherNet/IP protocol. It specifies the data format of the inverter status to be transmitted to the client (originator) during an I/O communication via a CIP (Common Industrial Protocol). Refer to the Assembly Object section of the EtherNet/IP.

Set value	Input instance value (E)	Data size (R/E)	Number of parameters (R/E)
0	70	4	X
1	71	4	X
2	110	4	X
3	111	4	X
4	141	2	1
5	142	4	2
6	143	6	3
7	144	8	4
8	145	10	5
9	146	12	6
10	147	14	7
11	148	16	8

⑥ **[CM-24] opt para-15: Reception data setting**

Used to monitor one of the smart scaling reception data of the G100 RAPIEnet+ communication board. You can select one of the data reception addresses from CM51 to CM58 for monitoring.

You can set “opt para-15 (smart scaling reception data index)” to between “0” and “11.” The description of the “opt para-15” settings are as follows.

The “opt para-15 (smart scaling reception data index)” setting cannot be written while the inverter is operating. Stop inverter operation before making changes to the setting.

This parameter is also required for EtherNet/IP protocol service. It configures the format of the command data transmitted to the inverter by the client (originator) during the I/O communication via the CIP (Common Industrial Protocol). Refer to the Assembly Object section of the EtherNet/IP.

Set value	Output instance value (E)	Data size (R/E)	Number of parameters (R/E)
0	20	4	X
1	21	4	X
2	100	4	X
3	101	4	X
4	121	2	1
5	122	4	2
6	123	6	3
7	124	8	4
8	125	10	5
9	126	12	6
10	127	14	7
11	128	16	8

⑦ **[CM-25] RAPIEnet Enable/Disable settings**

The RAPIEnet feature for the RAPIEnet+ communication board is “Enabled” by default. This feature is compatible with LS ELECTRIC products (XGL-EFMxB V8.0 or later) for the RAPIEnet v2 smart scaling service. (2: RAPIEnet v2 Enable / 0: RAPIEnet v2 Disable)

\*\* You can download the user manual (“Manual\_XGT\_FEnet”) at: <https://www.lselectric.co.kr>

If you have installed the G100 RAPIEnet+ communication board to an inverter made by another manufacturer (to utilize it as an G100 EtherNet communication board), set the parameter to “0,” then run “Comm Update” to operate the inverter with the RAPIEnet feature disabled.

### ⑧ **[CM-30] ParaStatus Num: Number of transmission data**

You can set CM-23 (opt para-14) to change the number of reception data to between “0” and “8.” The RAPIEnet+ communication board can transmit up to 8 pieces of data. You can configure the address of the transmission data with parameters CM-31 through CM-38.

### ⑨ **[CM-31] Para Status1 – [CM38] Para Status8: Transmission data address settings**

After setting the number of transmission data with CM-30, enter the matching number of data addresses for the data to transmit to the client (originator) with parameters CM-31 through CM-38.

This parameter setting is not required for Modbus TCP network communications.

### ⑩ **[CM-50] Para Ctrl Num: Number of reception data**

You can set CM-23 (opt para-14) to change the number of reception data to between “0” and “8.”

The RAPIEnet+ communication board can receive up to 8 pieces of data. You can configure the address for the received data with parameters CM-51 through CM-58.

### ⑪ **[CM-51] Para Control1 – [CM58] Para Control8: Reception data address settings**

After setting the number of reception data with CM-50, enter the matching number of data addresses for receiving command data from the client (originator) with parameters CM-51 through CM-58.

This parameter setting is not required for Modbus TCP network communications.

### ⑫ **[CM-94] Comm Update: Update setting changes via the communication board**

The CM group parameters display the settings stored on the inverter connected to the RAPIEnet+ communication board and the changes made on the keypad are not directly reflected on the RAPIEnet communication board.

The changed settings will be reflected on the RAPIEnet communication board when you set COM-94 (Comm Update) to “1 (Yes).” (Parameters that require communication updates include CM-7 and CM 10 through COM-25.)

## 10.4 PRT group (Lost Command)

### ① [Pr-12] Lost Cmd Mode: Operation mode for a command loss

You can select the operation mode for when a network failure or connection failure between the inverter and the communication occurs while the inverter is operated via network communication.

### ② [Pr-13] Lost Cmd Time: Decision time for a command loss

Set the time duration until the operation mode set with PR-12 will be reflected following a command loss. You can set a value between "0.1" and "120" seconds.

### ③ [Pr-14] Lost Preset F: Operation frequency for a command loss

When a lost command occurs, a protective function is activated and the inverter continues to operate using the frequency set with Pr-14. The setting value is from the start frequency to the max frequency [Hz].

### ④ Lost command conditions by protocol

- RAPIEnet

When the RAPIEnet master (XGL-EFMxB V8.0 or later) fails to receive data for the watchdog time, the communication board enters lost command mode, and the inverter will operate according to the settings at Pr-12 after the time set with Pr-13 has elapsed.

Refer to item 2 of section 11 for how to set the watchdog timer for the master module.

- EtherNet/IP

If the implicit message connection (Class 1 Connection) between the originator (a PLC or client) and the target (inverter) breaks for longer than one second, the EtherNet communication board enters lost command mode, and the inverter will operate according to the settings at Pr-12 after the time set with PRT-13 has elapsed.

- Modbus TCP

If the Modbus TCP receives no data from the client for five seconds, the EtherNet communication board enters lost command mode, and the inverter will operate according to the settings at Pr-12 after the time set with Pr-13 has elapsed.

# 11 Services with LS ELECTRIC products

## 11.1 Introduction

This chapter explains about services utilizing the RAPIEnet protocol when the communication board is connected with LS ELECTRIC products.

The keypad settings required to utilize the RAPIEnet service are as follows.

The RAPIEnet feature is enabled by default.

RAPIEnet+ communication board CM25 [Opt Parameter-16]	RAPIEnet v2 Availability	EtherNet/IP Availability	Modbus TCP Availability
Setting: '2' RAPIEnet v2 Enable	O	O	O
Setting: '0' RAPIEnet v2 Disable	X	O	O

## 11.2 Smart scaling (LS ELECTRIC master module: XGL-EFMxB V8.0 or later)

The smart scaling service is a communication service between automation products that allows for the extension of multiple PLCs and inverters utilizing simple configurations, without the need for complicated parameters settings or programming. The smart scaling service also has the EtherNet/IP service integrated within.

The G100 RAPIEnet+ communication board enables 8-word data input/out transmissions via an LS ELECTRIC master module, simply by configuring the number of transmission/reception data (CM-30/CM-50) and the addresses for transmission/reception data (CM-31 – CM-38 / CM-51 – CM-58). Besides, it provides various features, such as, monitoring of diagnostic parameters, RAPIEnet auto scan, and system diagnosis.

\*\* You can download the user manual ("Manual\_XGT\_FEnet\_V3.00") at: <https://www.lselectric.co.kr>

The following figure shows an example of the XG5000 settings screen for an LS ELECTRIC network master module (XGL-EFMxB V8.0 or later).

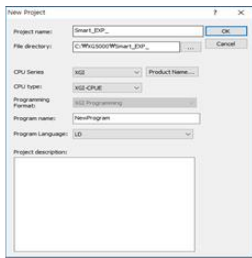

New Project create

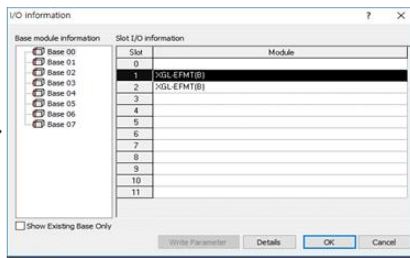

Master(Fenet) Module register

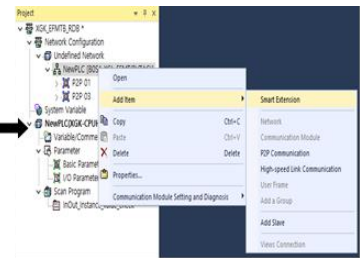

Add Smart Extension Service

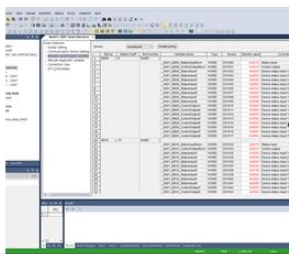

Input / Output Variable Assignment

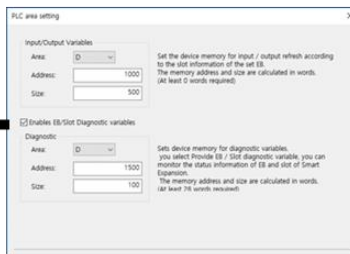

PLC Area Setting

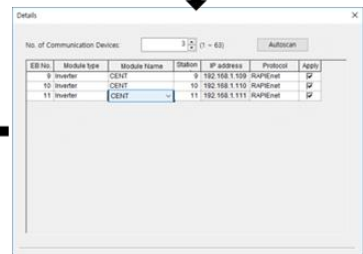

Smart Extension Autocan

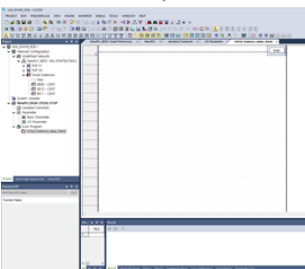

New Program create

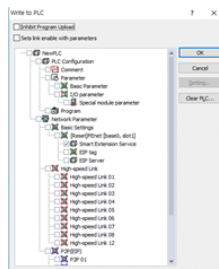

Program download

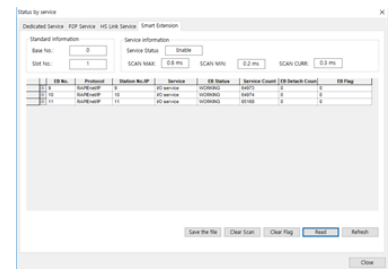

Check the service status

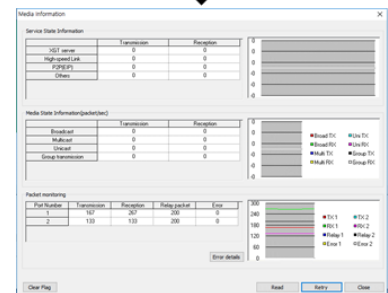

Media information



**Ref.**

“Smart scaling memory area settings”: The G100 RAPIEnet+ communication board has a 64-byte (32 Word) memory area assigned for it (fixed). When configuring the addresses, be careful not to use addresses already occupied by other programs to avoid collisions. Separate warnings are not provided, nor are duplicated addresses prohibited because users may configure a certain area of the addresses to be superimposed for special purposes.

### 11.2.1 Configuring the XG5000 program for the PLC

For an G100 inverter to communicate with the PLC via the RAPIEnet+ communication board, the XGL-EFMxB module (RAPIEnet I/F module) must be utilized. For a smart scaling service, the station ID (EB) and the IP address of the smart scaling device must be specified first: Ex. PAR->COM-07 (FBUS ID): “05,” PAR->COM-13 (Opt Parameter4): “100 + FBUS ID (05)” = “105” (This prevents IP address collisions between the communication boards installed to the inverters.) Refer to the user manual provided with the XGL-EFMxB product for detailed instructions.

Also, to configure a network communication utilizing a PLC system, installation of the XG5000 program is required. You can download XG5000 program from the LS ELECTRIC website.

\*\* Access the website (<https://www.lselectric.co.kr>) and download the document.

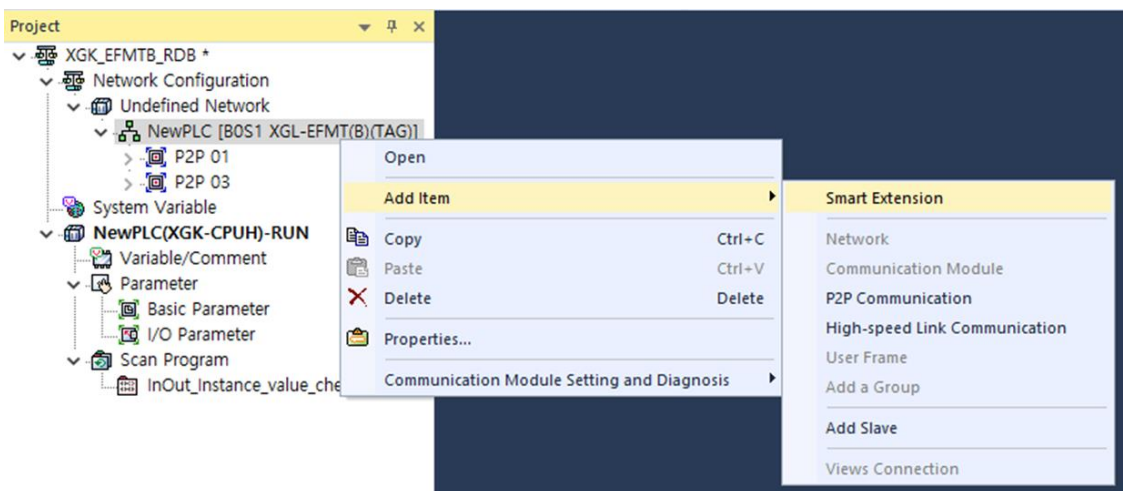

In the Connection tap of the Add Network Device window, you can configure the properties and click “OK” to add a network device [CENT] (RAPIEnet+ communication board) for a smart scaling service.

### 11.2.2 Configuring the master module

You can configure the “Watchdog timer” for a master module (XGL-EFMxB V8.0 or later). If lost command mode (Parameter->Pr-12 [Lost Cmd Mode]) is enabled on the keypad, the lost command time (Parameter->Pr-13 [Lost Cmd Time]) is extended by the time set as the watchdog time for the master module. Therefore, the watchdog time must be considered when setting the Parameter->Pr-13 (Lost Cmd Time) parameter value.

Watchdog timer: The time for the network device (G100 RAPIenet+ communication board) to monitor the uninterrupted network connection with the master module.

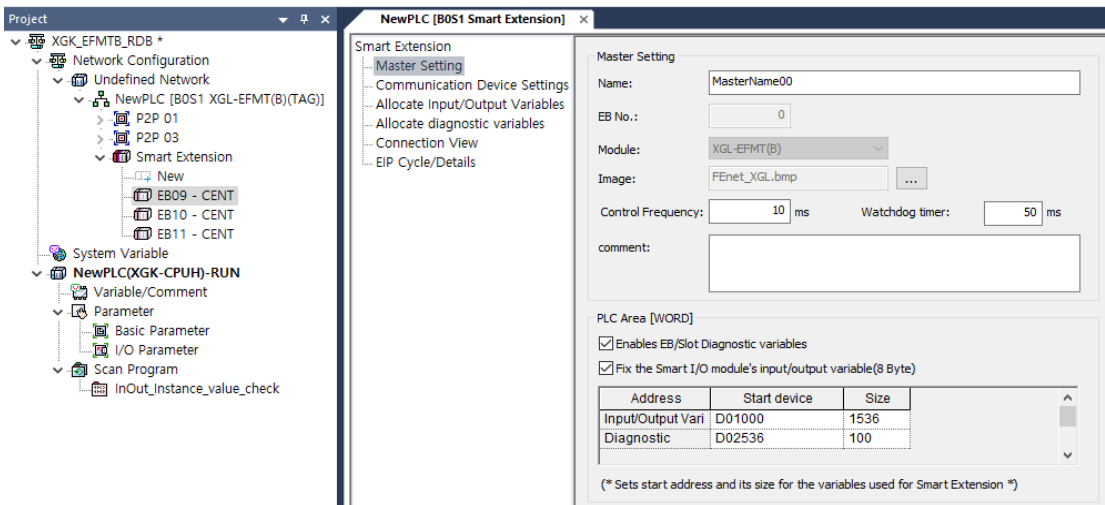

### 11.2.3 Network device settings

Select the hot swap feature. If the hot swap feature is not selected, losing one station ID (EB) on the network will cause the entire network to stop communicating.

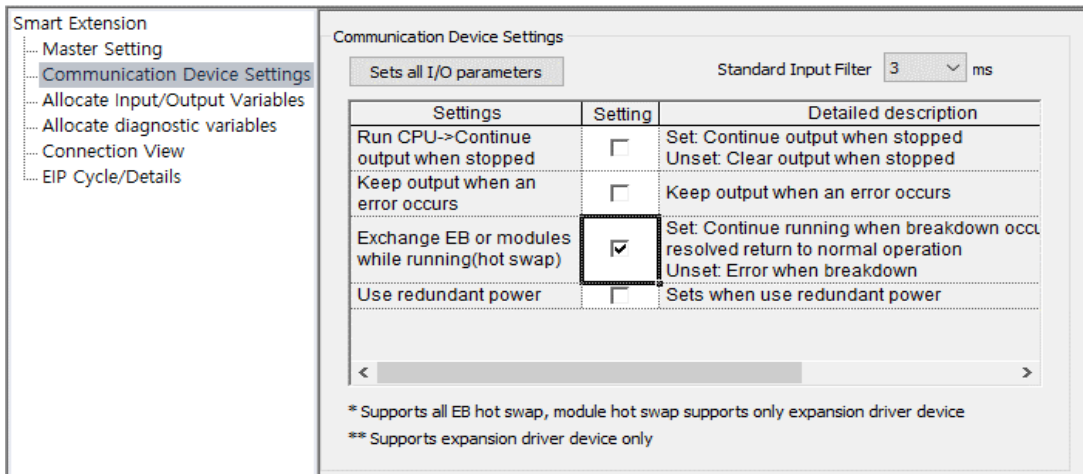

## 11.2.4 Input/Output parameter settings

The following settings enable an automatic 8 word / 8 word communication of input/output parameters.

Smart Extension		Format: <input type="text" value="Hexadecimal"/> <input type="text" value="Variable setting"/>						
EB No.	Station No/IP	Slot number	Variable name	Type	Device	Monitor value	Comment	
1	EB09	9	Slot00					
2			_0001_EB09_StatusInputNum	WORD	D01000	0x0010	Status input	
3			_0001_EB09_ControlOutputNum	WORD	D01001	0x0010	Control output	
4			_0001_EB09_StatusInput1	WORD	D01002	0x0000	Device status input 1	
5			_0001_EB09_StatusInput2	WORD	D01003	0x0000	Device status input 2	
6			_0001_EB09_StatusInput3	WORD	D01004	0x0000	Device status input 3	
7			_0001_EB09_StatusInput4	WORD	D01005	0x0000	Device status input 4	
8			_0001_EB09_StatusInput5	WORD	D01006	0x0129	Device status input 5	
9			_0001_EB09_StatusInput6	WORD	D01007	0x0000	Device status input 6	
10			_0001_EB09_StatusInput7	WORD	D01008	0x0000	Device status input 1	
11			_0001_EB09_StatusInput8	WORD	D01009	0x000B	Device status input 1	
12			_0001_EB09_ControlOutput1	WORD	D01010	0x0000	Device status input 1	
13			_0001_EB09_ControlOutput2	WORD	D01011	0x0000	Device status input 1	
14			_0001_EB09_ControlOutput3	WORD	D01012	0x0000	Device status input 1	
15			_0001_EB09_ControlOutput4	WORD	D01013	0x0000	Device status input 1	
16			_0001_EB09_ControlOutput5	WORD	D01014	0x0000	Device status input 1	
17			_0001_EB09_ControlOutput6	WORD	D01015	0x0000	Device status input 1	
18			_0001_EB09_ControlOutput7	WORD	D01016	0x0000	Device status input 1	
19			_0001_EB09_ControlOutput8	WORD	D01017	0x0000	Device status input 1	

## 11.2.5 Diagnostic parameter settings

Smart Extension		Format: <input type="text" value="Hexadecimal"/> <input type="text" value="Variable setting"/>						
EB No.	Station No/IP	Variable Kind	Variable name	Type	Device	Monitor value		
1	EB00	0/192.168.1.1	System diag					
2			_0001_STATUS_CHG_CNT	UINT	D02536	0x0002		
3			_0001_SCAN_MAX	UINT	D02537	0x0006		
4			_0001_SCAN_MIN	UINT	D02538	0x0003		
5			_0001_SCAN_CUR	UINT	D02539	0x0004		
6			_0001_SYSTEM_ER	BIT	D02540.0	0		
7			_0001_SYSTEM_WAR	BIT	D02540.1	0		
8			_0001_EB_DEER	BIT	D02540.2	0		
9			_0001_EB_BASE_INFO_ER	BIT	D02540.3	0		
10			_0001_IO_TYER	BIT	D02540.4	0		
11			_0001_IO_DEER	BIT	D02540.5	0		
12			_0001_FUSE_ER	BIT	D02540.6	0		
13			_0001_REF_TIME_OUT	BIT	D02540.7	0		
14			_0001_EB_CRC_ER	BIT	D02540.8	0		
15			_0001_TAG_ER	BIT	D02540.9	0		
16			_0001_SCAN_CLEAR	BIT	D02541.E	0		
17			_0001_ERR_CLEAR	BIT	D02541.F	0		
155			_0001_EB09_CFG_ER	BIT	D02558.0	0		
156			_0001_EB09_DEER	BIT	D02558.1	0		
157			_0001_EB09_REF_TIME_OUT	BIT	D02558.2	0		
158			_0001_EB09_P1_CRC_ER	BIT	D02558.3	0		
159			_0001_EB09_P2_CRC_ER	BIT	D02558.4	0		
160			_0001_EB09_IO_TYER	BIT	D02559.1	0		
161			Slot00					
162			_0001_EB09_S00_IO_TYER	BIT	D02560.0	0		
163	EB10	10	EB diagnosis					
164			_0001_EB10_CFG_ER	BIT	D02560.8	0		
165			_0001_EB10_DEER	BIT	D02560.9	0		
166			_0001_EB10_REF_TIME_OUT	BIT	D02560.A	0		
167			_0001_EB10_P1_CRC_ER	BIT	D02560.B	0		
168			_0001_EB10_P2_CRC_ER	BIT	D02560.C	0		
169			_0001_EB10_IO_TYER	BIT	D02561.9	0		
170			Slot00					
171			_0001_EB10_S00_IO_TYER	BIT	D02562.8	0		

## 11.2.6 Network device connections

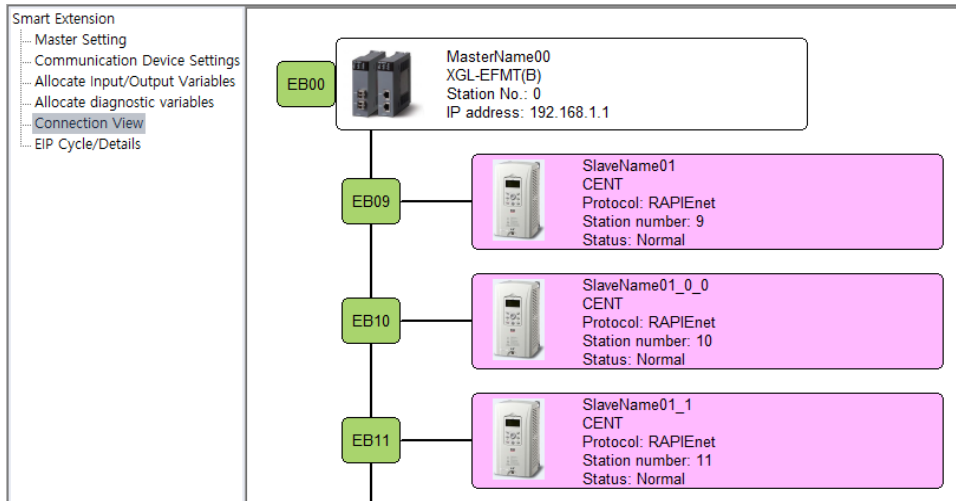

## 11.2.7 Service status

Service status shows the service operation status of the scaling service, service counts, and error counts. (Service status can be provided only when the system is online.)

- Click [Online] -> [Network module settings and diagnosis] -> [System diagnosis].

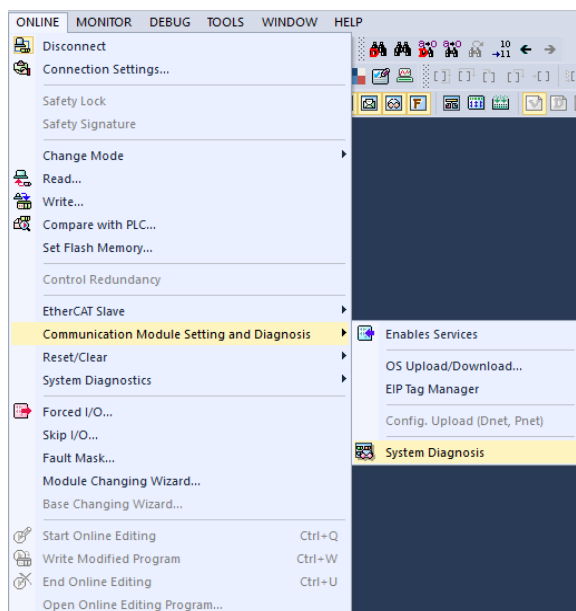

- ② In the [System diagnosis] window, right-click the master module (XGL-EFMxB) on the figure, then click Service status.

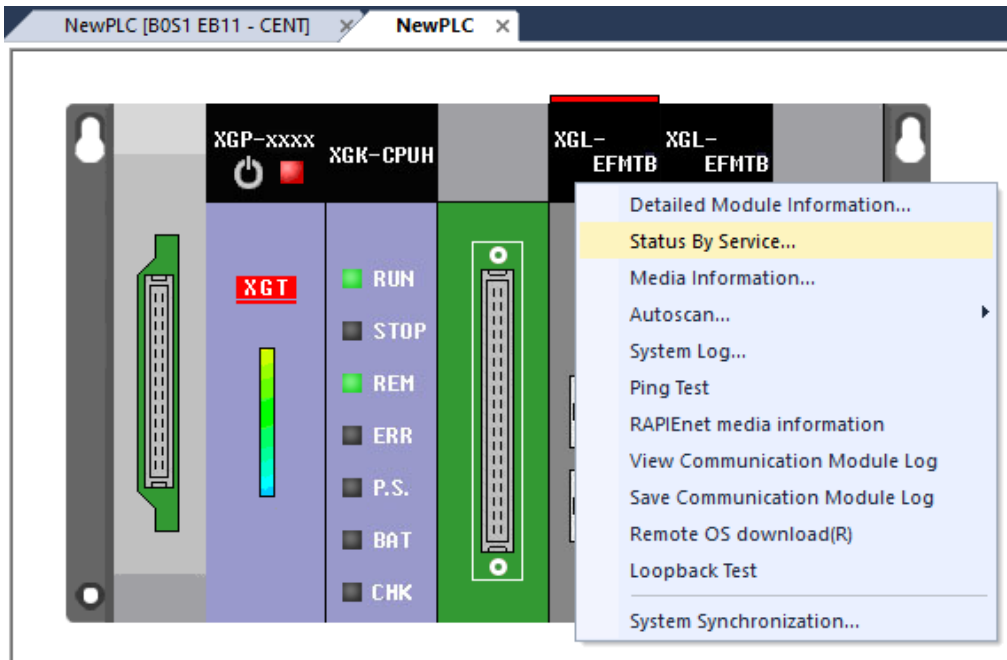

- ③ Click [Service status] -> [Smart scaling] tap to view the scaling service status.

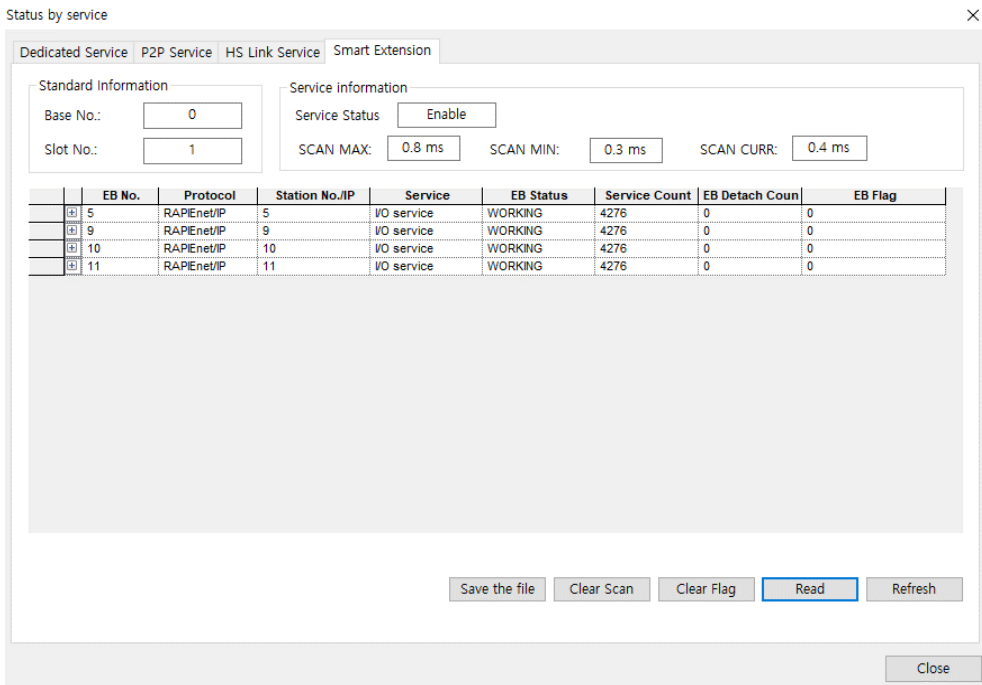

- ④ In step ②, you can click the [Auto scan] tap to view the RAPIEnet connection status.

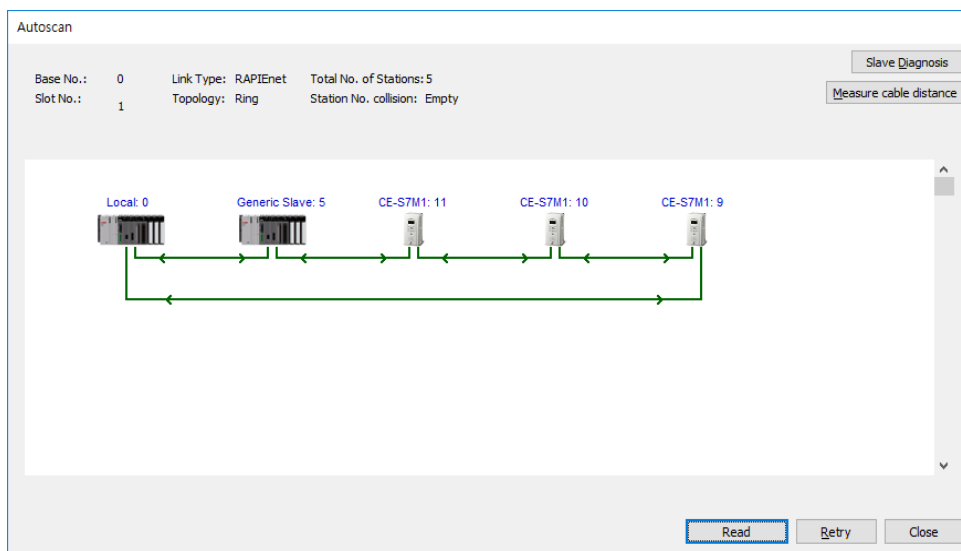

## 11.3 LED Indications and troubleshooting

LED name	Color	Description	Status	Status
LINK1	Green	Network normal	ON	Network connection at LINK 1 is operating normal
	Orange	Check network settings	ON	Check RAPIEnet network settings *1 When the communication cycle stops for longer than one second.
	-	LINK 1 Not connected	OFF	RAPIEnet communication is operating, but the network is not connected to LINK 1.
LINK2	Green	Network normal	ON	Network connection at LINK 2 is operating normal
	Orange	Network fault	ON	Check RAPIEnet network settings *1 When the communication cycle stops for longer than one second.
	-	LINK 1 Not connected	OFF	RAPIEnet communication is operating, but the network is not connected to LINK 2.

\*1: For a RAPIEnet network communication, check keypad parameter settings for CM-7, CM-13, CM-30, and CM-50, and the PLC settings. (When the RAPIEnet+ communication board is communicating with an LS ELECTRIC master module and the RAPIEnet network feature is enabled, the CM-7 [station ID] and CM-13 [IP address] parameters must be set to avoid collisions with other RAPIEnet+ communication boards on the same network.)

LED name	Color	Description	Status	Status
ERROR	Red	Normal operation	OFF	Communication between the communication board and the inverter is normal.
		Network fault	Flashing Synchronous flashing with LED0 (1 second interval)	Communication between the RAPIEnet+ communication board and the inverter is abnormal.
			Flashing (2 second interval)	The communication board parameters are set differently from the communication parameter settings on the keypad*2
			ON	EEPROM failure No network connection to LINK 1 and LINK 2 Station ID or IP address collision is detected.
CPU	Green	Normal operation	Flashing (1 second interval)	The communication board has been properly installed to the inverter.

\*2: To synchronize the Keypad parameter settings with the communication module settings, check the CM group settings and set CM-94 (Comm Update) to "1 (Yes)."

## 12 Services with LS ELECTRIC products or other manufacturer's products

### 12.1 Introduction

This chapter explains the services utilizing EtherNet/IP and Modbus TCP protocols when the communication board is connected with LS ELECTRIC products or another manufacturer's products.

The following keypad settings are required to disable the RAPIEnet service.

The RAPIEnet service feature is enabled by default.

RAPIEnet+ communication board CM25 [Opt Parameter-16]	RAPIEnet v2 Availability	EtherNet/IP Availability	Modbus TCP Availability
Setting: '2' RAPIEnet v2 Enable	O	O	O
Setting: '0' RAPIEnet v2 Disable	X	O	O



## 12.2 EtherNet/IP

### 12.2.1 Basic protocol structure

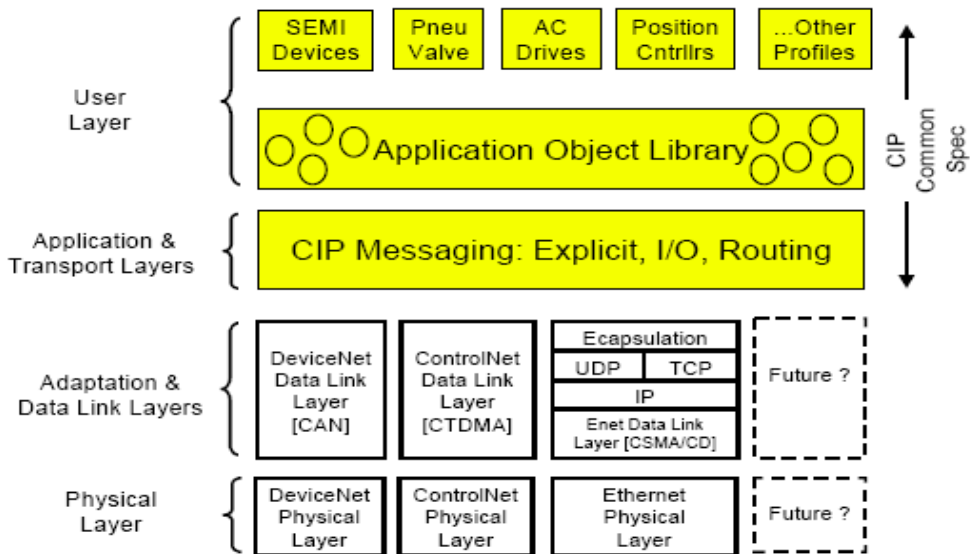

The EtherNet/IP is a protocol which implements the CIP (Common Industrial Protocol, specified by the ODVA) using the TCP and UDP protocols.

**Originator:** Devices that make connection requests, which are also called clients.

PLCs or scanners are examples of originators.

**Target:** Devices that respond to connection requests, which are also called servers.

Inverters are examples of targets.

## 12.2.2 Implicit message

Implicit messages are also called I/O messages. It refers to the data communicated between the client (originator) and the server (target) at predefined intervals, via input and output instances.

The class 1 connection is used for implicit messages.

### ① Scope of support

Transport type

Originator->Target: Point to Point

Target->Originator: Multicast

Transport trigger: Cyclic

Configuration connection: 1

Connection tag: Not available

Priority

Originator->Target: Scheduled

Target->Originator: Scheduled

Configuration data: Not available

### ② Input instances

Input instances refer to the status data periodically sent from the inverter to PLC or other client devices.

Instance	Byte	Bit 7	Bit 6	Bit 5	Bit 4	Bit 3	Bit 2	Bit 1	Bit 0
70	0						Running 1 (Fwd)		Faulted
	1								
	2	Speed Actual (Low Byte) – RPM unit (note 1)							
	3	Speed Actual (High Byte) – RPM unit							
71	0	At Reference	Ref From Net	Ctrl From Net	Ready	Running 2 (Rev)	Running 1 (Fwd)	Warning	Faulted
	1	Drive State							
	2	Speed Actual (Low Byte) – RPM unit							
	3	Speed Actual (High Byte) – RPM unit							
110	0						Running 1 (Fwd)		Faulted

Instance	Byte	Bit 7	Bit 6	Bit 5	Bit 4	Bit 3	Bit 2	Bit 1	Bit 0
	1								
	2	Speed Actual (Low Byte) – Hz unit (note 1)							
	3	Speed Actual (High Byte) – Hz unit							
111	0	At Reference	Ref From Net	Ctrl From Net	Ready	Running 2 (Rev)	Running 1 (Fwd)	Warning	Faulted
	1	Drive State							
	2	Speed Actual (Low Byte) – Hz unit							
	3	Speed Actual (High Byte) – Hz unit							
141	0	Status Parameter - 1 data (Low Byte)							
	1	Status Parameter - 1 data (High Byte)							
142	0	Status Parameter - 1 data (Low Byte)							
	1	Status Parameter - 1 data (High Byte)							
	2	Status Parameter - 2 data (Low Byte)							
	3	Status Parameter - 2 data (High Byte)							
143	0	Status Parameter - 1 data (Low Byte)							
	1	Status Parameter - 1 data (High Byte)							
	2	Status Parameter - 2 data (Low Byte)							
	3	Status Parameter - 2 data (High Byte)							
	4	Status Parameter - 3 data (Low Byte)							
	5	Status Parameter - 3 data (High Byte)							
144	0	Status Parameter - 1 data (Low Byte)							
	1	Status Parameter - 1 data (High Byte)							
	2	Status Parameter - 2 data (Low Byte)							
	3	Status Parameter - 2 data (High Byte)							
	4	Status Parameter - 3 data (Low Byte)							
	5	Status Parameter - 3 data (High Byte)							
	6	Status Parameter - 4 data (Low Byte)							
	7	Status Parameter - 4 data (High Byte)							
145	0	Status Parameter - 1 data (Low Byte)							
	1	Status Parameter - 1 data (High Byte)							
	2	Status Parameter - 2 data (Low Byte)							
	3	Status Parameter - 2 data (High Byte)							
	4	Status Parameter - 3 data (Low Byte)							
	5	Status Parameter - 3 data (High Byte)							
	6	Status Parameter - 4 data (Low Byte)							
	7	Status Parameter - 4 data (High Byte)							
	8	Status Parameter - 5 data (Low Byte)							
	9	Status Parameter - 5 data (High Byte)							
146	0	Status Parameter - 1 data (Low Byte)							

Instance	Byte	Bit 7	Bit 6	Bit 5	Bit 4	Bit 3	Bit 2	Bit 1	Bit 0
	1	Status Parameter - 1 data (High Byte)							
	2	Status Parameter - 2 data (Low Byte)							
	3	Status Parameter - 2 data (High Byte)							
	4	Status Parameter - 3 data (Low Byte)							
	5	Status Parameter - 3 data (High Byte)							
	6	Status Parameter - 4 data (Low Byte)							
	7	Status Parameter - 4 data (High Byte)							
	8	Status Parameter - 5 data (Low Byte)							
	9	Status Parameter - 5 data (High Byte)							
	10	Status Parameter - 6 data (Low Byte)							
	11	Status Parameter - 6 data (High Byte)							
147	0	Status Parameter - 1 data (Low Byte)							
	1	Status Parameter - 1 data (High Byte)							
	2	Status Parameter - 2 data (Low Byte)							
	3	Status Parameter - 2 data (High Byte)							
	4	Status Parameter - 3 data (Low Byte)							
	5	Status Parameter - 3 data (High Byte)							
	6	Status Parameter - 4 data (Low Byte)							
	7	Status Parameter - 4 data (High Byte)							
	8	Status Parameter - 5 data (Low Byte)							
	9	Status Parameter - 5 data (High Byte)							
	10	Status Parameter - 6 data (Low Byte)							
	11	Status Parameter - 6 data (High Byte)							
	12	Status Parameter - 7 data (Low Byte)							
13	Status Parameter - 7 data (High Byte)								
148	0	Status Parameter - 1 data (Low Byte)							
	1	Status Parameter - 1 data (High Byte)							
	2	Status Parameter - 2 data (Low Byte)							
	3	Status Parameter - 2 data (High Byte)							
	4	Status Parameter - 3 data (Low Byte)							
	5	Status Parameter - 3 data (High Byte)							
	6	Status Parameter - 4 data (Low Byte)							
	7	Status Parameter - 4 data (High Byte)							
	8	Status Parameter - 5 data (Low Byte)							
	9	Status Parameter - 5 data (High Byte)							
	10	Status Parameter - 6 data (Low Byte)							
	11	Status Parameter - 6 data (High Byte)							
	12	Status Parameter - 7 data (Low Byte)							
13	Status Parameter - 7 data (High Byte)								

Instance	Byte	Bit 7	Bit 6	Bit 5	Bit 4	Bit 3	Bit 2	Bit 1	Bit 0
	14	Status Parameter - 8 data (Low Byte)							
	15	Status Parameter - 8 data (High Byte)							

The following table explains the data (bytes 0 and 1) for instances 70, 71, 110, and 111.

Name	Description	Related attribute	
		Class	Attr. ID
Faulted	Inverter Error	0x29	10
Warning	Not supported	0x29	11
Running1	Motor is running Forward	0x29	7
Running2	Motor is running Reverse	0x29	8
Ready	Motor is ready for operation	0x29	9
Ctrl From Net	Run/Stop control	0x29	15
Ref From Net	Speed control	0x2A	29
At Reference	Reached reference Speed	0x2A	3
Drive State	Current motor status	0x29	6
Actual speed	Reference speed	0x2A	7

### ③ Output instances

Out instance refers to the status data periodically sent from the PLC or other client devices to the inverter.

Instance	Byte	Bit 7	Bit 6	Bit 5	Bit 4	Bit 3	Bit 2	Bit 1	Bit 0
20	0						Fault reset		Run Fwd
	1	0							
	2	Speed Reference (Low Byte) – RPM unit							
	3	Speed Reference (High Byte) – RPM unit							
21	0		NetRef (note 2)	NetCtrl (note2)			Fault reset	Run Rev	Run Fwd
	1	0							
	2	Speed Reference (Low Byte) – RPM unit							
	3	Speed Reference (High Byte) – RPM unit							
100	0						Fault reset		Run Fwd
	1	0							
	2	Speed Reference (Low Byte) – Hz unit							
	3	Speed Reference (High Byte) – Hz unit							
101	0		NetRef	NetCtrl			Fault reset	Run Rev	Run Fwd

Instance	Byte	Bit 7	Bit 6	Bit 5	Bit 4	Bit 3	Bit 2	Bit 1	Bit 0
	1	0							
	2	Speed Reference (Low Byte) – Hz unit							
	3	Speed Reference (High Byte) – Hz unit							
121	0	Control Parameter - 1 data (Low Byte)							
	1	Control Parameter - 1 data (High Byte)							
122	0	Control Parameter - 1 data (Low Byte)							
	1	Control Parameter - 1 data (High Byte)							
	2	Control Parameter - 2 data (Low Byte)							
	3	Control Parameter - 2 data (High Byte)							
123	0	Control Parameter - 1 data (Low Byte)							
	1	Control Parameter - 1 data (High Byte)							
	2	Control Parameter - 2 data (Low Byte)							
	3	Control Parameter - 2 data (High Byte)							
	4	Control Parameter - 3 data (Low Byte)							
	5	Control Parameter - 3 data (High Byte)							
124	0	Control Parameter - 1 data (Low Byte)							
	1	Control Parameter - 1 data (High Byte)							
	2	Control Parameter - 2 data (Low Byte)							
	3	Control Parameter - 2 data (High Byte)							
	4	Control Parameter - 3 data (Low Byte)							
	5	Control Parameter - 3 data (High Byte)							
	6	Control Parameter - 4 data (Low Byte)							
	7	Control Parameter - 4 data (High Byte)							
125	0	Control Parameter - 1 data (Low Byte)							
	1	Control Parameter - 1 data (High Byte)							
	2	Control Parameter - 2 data (Low Byte)							
	3	Control Parameter - 2 data (High Byte)							
	4	Control Parameter - 3 data (Low Byte)							
	5	Control Parameter - 3 data (High Byte)							
	6	Control Parameter - 4 data (Low Byte)							
	7	Control Parameter - 4 data (High Byte)							
	8	Control Parameter - 5 data (Low Byte)							
	9	Control Parameter - 5 data (High Byte)							
126	0	Control Parameter - 1 data (Low Byte)							
	1	Control Parameter - 1 data (High Byte)							
	2	Control Parameter - 2 data (Low Byte)							
	3	Control Parameter - 2 data (High Byte)							
	4	Control Parameter - 3 data (Low Byte)							
	5	Control Parameter - 3 data (High Byte)							

Instance	Byte	Bit 7	Bit 6	Bit 5	Bit 4	Bit 3	Bit 2	Bit 1	Bit 0
	6	Control Parameter - 4 data (Low Byte)							
	7	Control Parameter - 4 data (High Byte)							
	8	Control Parameter - 5 data (Low Byte)							
	9	Control Parameter - 5 data (High Byte)							
	10	Control Parameter - 6 data (Low Byte)							
	11	Control Parameter - 6 data (High Byte)							
127	0	Control Parameter - 1 data (Low Byte)							
	1	Control Parameter - 1 data (High Byte)							
	2	Control Parameter - 2 data (Low Byte)							
	3	Control Parameter - 2 data (High Byte)							
	4	Control Parameter - 3 data (Low Byte)							
	5	Control Parameter - 3 data (High Byte)							
	6	Control Parameter - 4 data (Low Byte)							
	7	Control Parameter - 4 data (High Byte)							
	8	Control Parameter - 5 data (Low Byte)							
	9	Control Parameter - 5 data (High Byte)							
	10	Control Parameter - 6 data (Low Byte)							
	11	Control Parameter - 6 data (High Byte)							
	12	Control Parameter - 7 data (Low Byte)							
	13	Control Parameter - 7 data (High Byte)							
128	0	Control Parameter - 1 data (Low Byte)							
	1	Control Parameter - 1 data (High Byte)							
	2	Control Parameter - 2 data (Low Byte)							
	3	Control Parameter - 2 data (High Byte)							
	4	Control Parameter - 3 data (Low Byte)							
	5	Control Parameter - 3 data (High Byte)							
	6	Control Parameter - 4 data (Low Byte)							
	7	Control Parameter - 4 data (High Byte)							
	8	Control Parameter - 5 data (Low Byte)							
	9	Control Parameter - 5 data (High Byte)							
	10	Control Parameter - 6 data (Low Byte)							
	11	Control Parameter - 6 data (High Byte)							
	12	Control Parameter - 7 data (Low Byte)							
	13	Control Parameter - 7 data (High Byte)							
	14	Control Parameter - 8 data (Low Byte)							
	15	Control Parameter - 8 data (High Byte)							

The following table explains the data (bits for byte 0) for instances 20, 21, 100, and 101.

Name	Description	Related attribute	
		Class	Attr. ID
Run Fwd (Note1)	Forward Run Command	0x29	3
Run Rev (Note1)	Reverse Run Command	0x29	4
Fault reset (Note1)	Fault Reset Command	0x29	12
NetRef (Note2)	Not used	0x2A	4
NetCtrl (Note2)	Not used	0x29	5
Speed Reference	Reference speed	0x2A	8

(Note1) Refer to the Drive Run and Fault sections in the "Control Supervisor Object (Class 0x29)".

(Note2) Reference speed and Run/Stop control can be set only on the LCD control panel. Network control instances 21 and 101 (NetRef, NetCtrl) are not available.

### 12.2.3 Explicit messages

Explicit messages refer to non-periodic data communications used for reading or writing attribute values of an inverter or an EtherNet/IP.

Using the UCMM communication, data exchange is made without connecting the originator and the target, and periodic data exchange is available as well using the Class 3 connection.



## 12.2.4 Supported objects

### ① Identity Object (Class 0x01, Instance 1)

#### Attribute

Attribute ID	Access	Attribute Name	Data Length	Attribute Value
1	Get	Vendor ID	Word	259
2	Get	Device Type (inverter)	Word	2
3	Get	Product Code	Word	100 (Note1)
4	Get	Revision High Byte - Major Revision Low Byte - Minor Revision	Word	(Note2) 0x0101
5	Get	Status	Word	(Note3)
6	Get	Serial Number	Double Word	(Note4)
7	Get	Product Name	4 Byte	CENT

(Note1) Product Code 100 refers to the LS ELECTRIC inverter.

(Note2) The revision number is identical to the version of the EtherNet communication board. The high byte stands for a major revision number, and the low byte stands for a minor revision number. For example, "0x0102" stands for "version 1.02." The version of the EtherNet communication board can be displayed on the Keypad using the CM-6 (FBus S/W Ver) parameter.

(Note3) Definition of status bits

Bit	Description
0	0: Device is not connected to the master 1: Device is connected to the master
1	Reserved
2	Configured (fixed as '0' because LS ELECTRIC EtherNet/IP is not supported)
3	Reserved
4	0: Unknown
5	2: Faulty IO connection
6	3: IO connection has not been made
7	5: Major fault 6: IO connection has been made
8	Minor recoverable fault (Inverter is in warning status)
9	Minor unrecoverable fault (N/A)
10	Major recoverable fault (inverter H/W trip occurred)
11	Major recoverable fault (inverter non-H/W trip occurred)

(Note4) Serial number uses the last 4 digits of the MAC ID.

E.g.) The serial number is 0x29000022 when the MAC ID is "00:0B:29:00:00:22".

**Service**

Service code	Definition	Support for class	Support for instance
0x0E	Get Attribute Single	No	Yes
0x05	Reset	No	Yes
0x01	Get Attribute All	No	Yes

② **Motor data object (Class 0x28, Instance 1)**

**Attribute**

Attribute ID	Access	Attribute Name	Range	Definition
3	Get	Motor Type	0 – 10	0: Non-standard motor 1: PM DC Motor 2: FC DC Motor 3: PM Synchronous Motor 4: FC Synchronous Motor 5: Switched Reluctance Motor 6: Wound Rotor Induction Motor 7: Squirrel Cage Induction Motor 8: Stepper Motor 9: Sinusoidal PM BL Motor 10: Trapezoidal PM BL Motor
6	Get/Set	Motor Rated Curr	0.0 – 1000.0	[Get] Reads the value at BAS-13 Rated Curr. [Set] Set value is reflected to BAS-13 Rated Curr. Scale 0.1
7	Get/Set	Motor Rated Volt	0 – 690	[Get] Reads the value of the BAS-15 Rated Voltage. [Set] Set value is reflected in the BAS-15 Rated Voltage. Scale 1

**Service**

Service code	Definition	Support for class	Support for instance
0x0E	Get Attribute Single	No	Yes
0x10	Set Attribute Single	No	Yes

**③ Control Supervisor Objects (Class 0x29, Instance 1)**

**Attribute**

Attribute ID	Access	Attribute Name	Range	Definition
3	Get/Set	Forward Run Cmd.	0	Stopped
			1	Forward run (Note1)
4	Get/Set	Reverse Run Cmd.	0	Stopped
			1	Reverse run (Note1)
5	N/A	Net Control	-	Configurable only with the inverter parameter.
6	Get	Drive State	0	Vendor Specific
			1	Startup
			2	Not Ready (resetting in progress)
			3	Ready (stopping in progress)
			4	Enabled (running, not applicable to deceleration stop)
			5	Stopping (decelerating)
			6	Fault Stop
7	Get	Running Forward	0	Drive stopped.
			1	Running Forward
8	Get	Running Reverse	0	Drive stopped.
			1	Running Reverse
9	Get	Drive Ready	0	Resetting in progress or trip occurred
			1	Inverter is ready for operation
10	Get	Drive Fault	0	Trip has not occurred
			1	Trip has occurred
12	Get/Set	Drive Fault Reset	0	Trip reset to release the trip. Resetting will begin only when the

Attribute ID	Access	Attribute Name	Range	Definition
			1	value changes from FALSE to TRUE. (Note2)
13	Get	Drive Fault Codes		Refer to the following Drive Fault Code table (Note2)
14	Get	Control From Net.	0	Commands are made using sources other than the DeviceNet communication.
			1	Commands are made using the DeviceNet communication as the source.

(Note1) Drive Run Inverter operation using Command Forward Run Cmd. and Reverse Run Cmd.

Run1	Run1	Trigger Event	Run Type
0	0	Stop	NA
0 → 1	0	Run	Run1
0	0 → 1	Run	Run2
0 → 1	0 → 1	No Action	NA
1	1	No Action	NA
1 → 0	1	Run	Run2
1	1 → 0	Run	Run1

In the table above, Run1 indicates Forward Run Cmd. and Run 2 indicates Reverse Run Cmd. Commands are made by the EtherNet communication board when the value changes from 0 (FALSE) to 1 (TRUE). The Forward Run Cmd. value does not indicate the present operation status of the inverter; it indicates the operation command value on the EtherNet communication board.

(Note2) Drive Fault

The Drive Fault becomes TRUE when the inverter is tripped.  
The Drive Fault Codes for the trips are as follows.

### Drive Fault Codes

Fault Code Number	Description
0x0000	None
0x1000	Ethermal
	Out Phase Open
	InPhaseOpen
	ThermalTrip
	UnderLoad
0x2200	ParaWriteTrip
	IOBoardTrip
	PrePIDFail
0x2310	OptionTrip1
	OptionTrip2
	OptionTrip3
0x2200	OverLoad
0x2310	OverCurrent1
LostCommand	UNDEFINED
LostKeypad	

Fault Code Number	Description	
0x2330	GFT	
0x2340	OverCurrent2	
0x3210	OverVoltage	
0x3220	LowVoltage	
0x2330	GroundTrip	
0x4000	NTCOpen	
0x4200	OverHeat	
0x5000	FuseOpen	HWDiag
0x7000	FanTrip	
0x7120	No Motor Trip	
0x7300	EncorderTrip	
0x8401	SpeedDevTrip	
0x8402	OverSpeed	
0x9000	ExternalTrip	BX

### Drive Fault Reset

The Drive Fault Reset gives TRIP RESET reference to the inverter when the setting value changes from 0 to 1 (FALSE to TRUE). Overwriting 1 (TRUE) over 1 (TRUE) does not generate RESET reference for a trip. To allow the EtherNet communication board to send a RESET command to the inverter when the value is 1 (TRUE), write 0 (FAULT) first, then write 1 (TRUE) again.

### Service

Service code	Definition	Support for class	Support for instance
0x0E	Get Attribute Single	No	Yes
0x10	Set Attribute Single	No	Yes

### ④ Inverter Objects (Class 0x2A, Instance 1)

#### Attribute

Attribute ID	Access	Attribute Name	Range	Definition
3	Get	At Reference	0	The output frequency has not reached the reference frequency.
			1	The output frequency has reached the reference frequency.
4	N/A	Net Reference	-	

Attribute ID	Access	Attribute Name	Range	Definition
6	Get	Drive Mode (Note1)	0	Vendor Specific Mode
			1	Open Loop Speed (Frequency)
			2	Closed Loop Speed Control
			3	Torque Control
			4	Process Control (e.g. PI)
7	Get	SpeedActual	0 – 24000	Displays the present output frequency in [rpm].
8	Get/Set	SpeedRef	0 – 24000	Displays the reference frequency in [rpm]. Reflected when DRV-07 (Freq Ref Src) is set to FieldBus.
9	Get	Actual Current	0 – 111.0 A	Monitors the present current in 0.1 A increment/decrement.
29	Get	Ref.From Network	0	Command source is not the DeviceNet communication.
			1	Command source is the DeviceNet communication.
100	Get	Actual Hz	0 – 400.00 Hz	Monitors the present operation frequency (Hz).
101	Get/Set	Reference Hz	0 – 400.00 Hz	Speed reference may be given via a network communication if DRV-07 (Freq Ref Src) is set to 8 (FieldBus).
102	Get/Set	Acceleration Time (Note2)	0 – 6000.0 sec	Sets/monitors the acceleration time of the inverter.
103	Get/Set	Deceleration Time (Note3)	0 – 6000.0 sec	Sets/monitors the deceleration time of the inverter.

(Note1) Related to the DRV-10 (Torque Control) and APP-01 (App Mode) settings. When DRV-10 (Torque Control) is set to Yes, the Drive Mode becomes "Torque Control", and when APP-01 (App Mode) is set to Proc PID, MMC, then the Drive Mode becomes "Process Control (e.g. PI)."

(Note2) Value at DRV-03 (Acc Time)

(Note3) Value at DRV-04 (Dec Time)

## Service

Service code	Definition	Support for class	Support for instance
0x0E	Get Attribute Single	No	Yes
0x10	Set Attribute Single	No	Yes

⑤ **Class 0x64 (Inverter Object) – Manufacture Profile**

This object is used to access the Keypad Parameters of the inverter.

**Attribute**

Instance	Access	Attribute Number	Attribute Name	Attribute Value
1 (DRV Group)	Get/Set	Identical to the G100 Manual Code number.	G100 Keypad Title (Refer to the G100 inverter user manual)	Parameter setting range for the G100 inverter (Refer to the G100 inverter user manual)
2 (BAS Group)		Identical to the G100 Manual Code number.		
3 (ADV Group)		Identical to the G100 Manual Code number.		
4 (CON Group)		Identical to the G100 Manual Code number.		
5 (IN Group)		Identical to the G100 Manual Code number.		
6 (OUT Group)		Identical to the G100 Manual Code number.		
7 (COM Group)		Identical to the G100 Manual Code number.		
8 (APP Group)		Identical to the G100 Manual Code number.		
9 (AUT Group)		Identical to the G100 Manual Code number.		
10 (APO Group)		Identical to the G100 Manual Code number.		
11 (PRT Group)		Identical to the G100 Manual Code number.		
12 (M2 Group)		Identical to the G100 Manual Code number.		

**Service**

Service code	Definition	Support for class	Support for instance
0x0E	Get Attribute Single	No	Yes
0x10	Set Attribute Single	No	Yes

## 12.3 Modbus TCP frame

### 12.3.1 Modbus TCP frame structure

MBAP Header (7 bytes)	PDU (5 bytes or greater)
-----------------------	--------------------------

In general, EtherNet communication uses EtherNet II frames.

#### MODBUS Application Protocol header (MBAP header)

The following table explains the components of a MBAP header.

Section	Length	Description
Transaction identifier	2 byte	Unique transmission number, which increases by 1 each time the client sends data frame to the server.
Protocol identifier	2 byte	Fixed at 0.
Length	2 byte	Data frame length of the Modbus communication, which represents the length (in byte unit) from the MBAP header to the unit identifier.
Unit identifier	1 byte	When communications using Modbus TCP and Modbus RTU are connected via a gateway, the unit identifier indicates the slave number. The address is fixed to 0xFF when Modbus TCP communication is used alone.

#### Protocol Data Unit (PDU)

PDU is the actual data in the Modbus TCP communication, which is composed of a function code and data.

Refer to "12.3.2 Function codes" below for detailed information.



## 12.3.2 Function codes

The Modbus TCP communication involves clients and a server. During communication, clients send commands to the server, and the server responds to the commands. In general, devices such as a PLC, HMI, and PC are used as the client, and the inverter works as a server.

### ① Read Holding registers

Read Input registers are functions used to read the server (inverter) data.

The following table explains the components of a request data frame from a client to a server.

Request frame	Length	Value
Function code	1 byte	0x03
Comm. address	2 byte	0x0000–0xFFFF
Number of data requests	2 byte	1–16 (LS ELECTRIC inverters)

The following table explains the components of a response data frame from a server to a master.

Response frame	Length	Value
Function code	1 byte	0x03
Comm. address	1 byte	2 x the number of data requests
Number of data requests	Number of data requests x 2 bytes	Data value of the given number from the comm. address

### ② Read Input registers

Read Input registers are functions used to read the server (inverter) data.

The following table explains the components of a request data frame from a client to a server.

Request frame	Length	Value
Function code	1 byte	0x04
Comm. address	2 byte	0x0000–0xFFFF
Number of data requests	2 byte	1–16 (LS ELECTRIC inverters)

The following table explains the components of a response data frame from a server to a master.

Response frame	Length	Value
Function code	1 byte	0x03
Comm. address	1 byte	2 x the number of data requests
Number of data requests	Number of data requests x 2 bytes	Data value of the given number from the comm. address

### ③ Write Single register

Write Single registers are functions used to write a single server (inverter) data.

The following table explains the components of a request data frame from a client to a server.

Request frame	Length	Value
Function code	1 byte	0x06
Comm. address	2 byte	0x0000–0xFFFF
Data value	2 byte	0x0000–0xFFFF

The following table explains the components of a response data frame from a server to a master.

Response frame	Length	Value
Function code	1 byte	0x06
Comm. address	2 byte	0x0000–0xFFFF
Data value	2 byte	0x0000–0xFFFF

### ④ Write Multiple register

Write Multiple registers are functions used to write 1 to 16 consecutive data items on the server (inverter).

The following table explains the components of a request data frame from a client to a server.

Request frame	Length	Value
Function code	1bytes	0x10
Comm. address	2bytes	0x0000–0xFFFF
Number of data to write	2byte	1–16 (LS ELECTRIC inverters)
Byte Count	1byte	2 x the number of data
Number of data to write	The number of data x 2 bytes	Data to write

The following table explains the components of a response data frame from a server to a master.

Response frame	Length	Value
Function code	1 byte	0x10
Comm. address	2 byte	0x0000–0xFFFF
Number of data to write	2 byte	1–16 (LS ELECTRIC inverters)

### 12.3.3 Exception (Except) frame

An exception frame is a response frame from a server when an error occurs while responding to the client.

The following table explains the components of an exception frame.

Error frame	Length	Value
Error code	1bytes	0x80 + function code requested by the client
Exception code	1bytes	0x0000–0xFFFF

#### Exception code

Type	Code	Description
ILLEGAL FUNCTION	0x01	Unsupported function has been requested
ILLEGAL DATA ADDRESS	0x02	An unused address has been requested or modification has been requested for the data at an unused address.
ILLEGAL DATA VALUE	0x03	A data modification request has been made out of the range of the available value.
SLAVE DEVICE FAILURE	0x04	Server error occurred (CAN communication error with the drive, communication board initialization error, or data communication error with the drive)
SLAVE DEVICE BUSY	0x06	Server is unable to respond because it is executing another process (in the middle of a drive parameter initialization or the initial setting of the communication board)
WRITE PERMISSION ERROR	0x20	Unique code for LS ELECTRIC inverters. An attempt was made to change a write-protected parameter

## 12.4 LED Indications and troubleshooting

LED name	Color	Description	Status	Status
LINK1	Green	Network normal	ON	Network connection at LINK 1 is operating normal
	Orange	Check network settings	ON	Check EtherNet settings*1 When the communication cycle stops for longer than one second.
	-	LINK 1 Not connected	OFF	Trying EtherNet communication, network cable not connected to LINK 1
LINK2	Green	Network normal	ON	Network connection at LINK 2 is operating normal
	Orange	Network fault	ON	Check EtherNet settings*1
	-	LINK 1 Not connected	OFF	Trying EtherNet communication, network cable not connected to LINK 2

\*1: For EtherNet network settings, check keypad parameters COM-10, COM-11, COM-14, COM-15, COM-23, and COM-24, and the settings for the client devices, such as the PLC.

LED name	Color	Description	Status	Status
ERROR	Red	Normal operation	OFF	Communication between the communication board and the inverter is normal.
		Network fault	Flashing Synchronous flashing with LED0 (1 second interval)	Communication between the RAPIEnet+ communication board and the inverter is abnormal.
			Flashing (2 second interval)	The communication board parameters are set differently from the communication parameter settings on the keypad*2
			ON	EEPROM failure No network connection to LINK 1 and LINK 2 IP collision occurred
CPU	Green	Normal operation	Flashing (1 second interval)	The communication board has been properly installed on the inverter.

\*2: To synchronize the EtherNet communication board settings with the keypad parameter settings, check the CM Group parameter settings and set CM-94 (Comm. Update) to "1 (yes)."

