

The right choice for the ultimate yield!

LS ELECTRIC strives to maximize your profits in gratitude for choosing us as your partner.

Profibus-DP Option Module

LSLV-G100 series

User's Manual

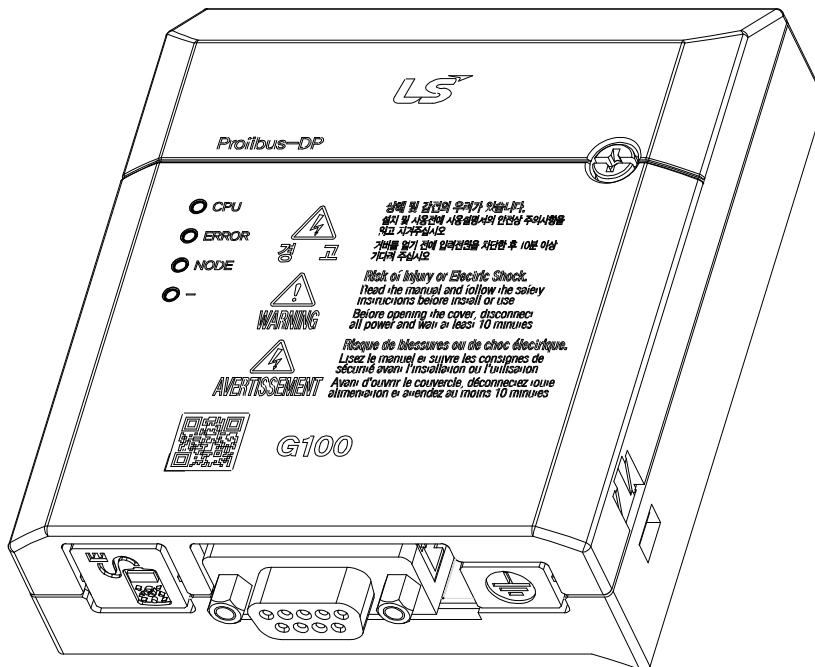

Safety Instructions

- Use this board after read Safety Instruction of this manual carefully before using and follow the instructions exactly.
- Please hand this user manual to end user and trouble shooting manager
- After read this manual, keep it at handy for future reference.
- 사용 전에 '안전상의 주의사항'을 반드시 읽고 정확하게 사용하여 주십시오.
- 본 설명서는 제품을 사용하는 사람이 항상 볼 수 있는 곳에 잘 보관하십시오.

LSELECTRIC

Before using the product

Thank you for using the G100 PROFIBUS-DP communication module.

SAFETY PRECAUTIONS

- Always follow safety instructions to prevent accidents and potentially hazardous situations.
- Safety precautions are classified into "WARNING" and "CAUTION," and their meanings are as follows:

Warning

Improper operation may result in serious personal injury or death.

Caution

Improper operation may result in minor personal injury or property damage.

- Symbols used in this document and on the product indicate the following.

 Danger may be present. Read the message and carefully follow the instructions.

 Close attention should be paid because the risk of electric shock may be present.

- Keep the operating instructions handy for quick reference.
- Read the operating instructions carefully to fully understand the functions of the LSLV-G100 PROFIBUS-DP communication module and use it properly.

Caution

- **Be careful not to damage the CMOS elements on the communication module.**
Static charge may cause malfunctioning of the product.
- **Turn off the inverter before connecting communication cables.**
Otherwise, the module may be damaged or a communication error may result.
- **Correctly install the communication module and ensure that it is firmly connected to the inverter.**
Otherwise, the module may be damaged or a communication error may result.
- **Check the parameter units when configuring the parameter values.**
Otherwise, a communication error may occur.

Table of Contents

1 Overview	1
1.1 What is the PROFIBUS-DP Communication Module?	1
1.2 Package Content	1
2 LSLV-G100 PROFIBUS-DP Communication Module	2
2.1 Technical Specifications	2
2.2 PROFIBUS-DP Communication Module Layout	3
2.3 PROFIBUS-DP Connector Specifications	4
2.4 Installation	5
2.5 Network Cable Specifications	7
2.6 Network Cable Length by Baud Rate	7
3 Operation Status and LED Indicators	8
3.1 LED Indicators	8
3.2 Device Status by Indicator Signal	9
4 Inverter Parameters	11
4.1 PROFIBUS-DP Communication Parameter List.....	11
4.2 PROFIBUS-DP Communication Parameters	12
4.2.1 Communication module Version.....	12
4.2.2 Station ID Setting	12
4.2.3 LED Indication for Communication Status	13
4.2.4 Number of Para Status settings.....	14
4.2.5 Para Status 1–8	15

Table of Contents

4.2.6	Number of Para Control settings	16
4.2.7	Para Control 1–8.....	17
4.2.8	Comm Update.....	18
4.2.9	Setting PROFIBUS Bit Swap	18
5	GSD File (Electronic Data Sheets)	19

1 Overview

The PROFIBUS-DP communication module allows the LSLV-G100 inverter to connect to a PROFIBUS network.

1.1 What is the PROFIBUS-DP Communication Module?

Using the network features, controlling and monitoring of the inverter can be performed via a PLC sequence program or a master device.

Because multiple inverters can be operated with one communication cable, this reduces the total installation cost. In addition, installation time is reduced and easy maintenance is made available because installation and routing of cables has become simpler.

Factory automation can also be easily implemented by linking various auxiliary devices with a PLC and by utilizing other control systems, such as a PC, for controlling the inverter.

1.2 Package Content

The product package includes the following components.

- PROFIBUS-DP communication module (CPDP-G100): 1 ea
- User manual: 1 ea
- PROFIBUS connector: 1 ea

2 LSLV-G100 PROFIBUS-DP Communication Module

2.1 Technical Specifications

Type	Description
Device Type	PROFIBUS-DP slave
Auto Baud Rate Detect	Supported
Sync Mode	Supported
Freeze Mode	Supported
Max Input Length	8 words
Max Output Length	8 words
Baud Rate Support	9.6K, 19.2K, 93.75K, 187.5K, 500K, 1.5M, 3M, 6M, 12M
Modular Station	Supported
Max Module	2
Max. Number of Nodes	Max. 32 nodes without a repeater (including the master node)
LED indicator	3 indicators (ERROR, NODE, and CPU)
Communication connector	9 pin D-sub

Table 1 Technical Specifications

2.2 PROFIBUS-DP Communication Module Layout

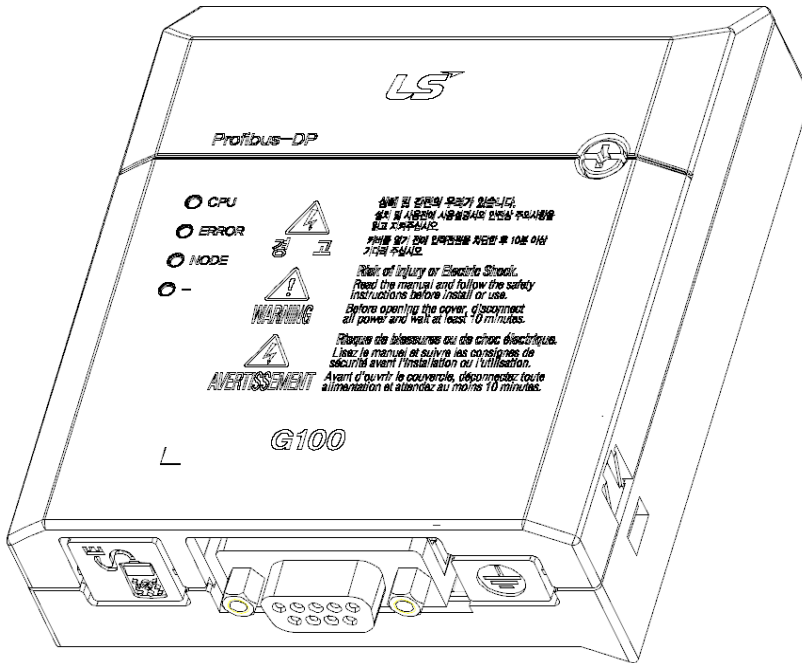
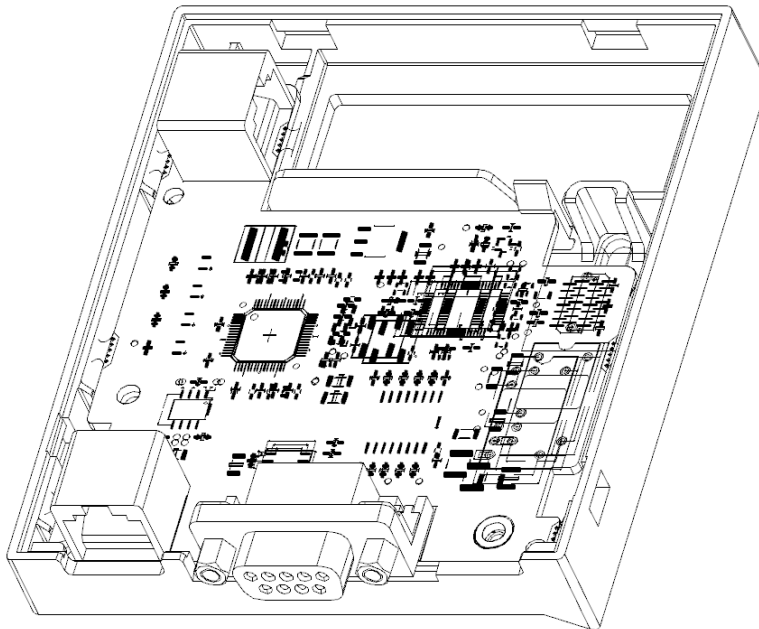

Figure 1 PROFIBUS-DP Communication Module



2.3 PROFIBUS-DP Connector Specifications

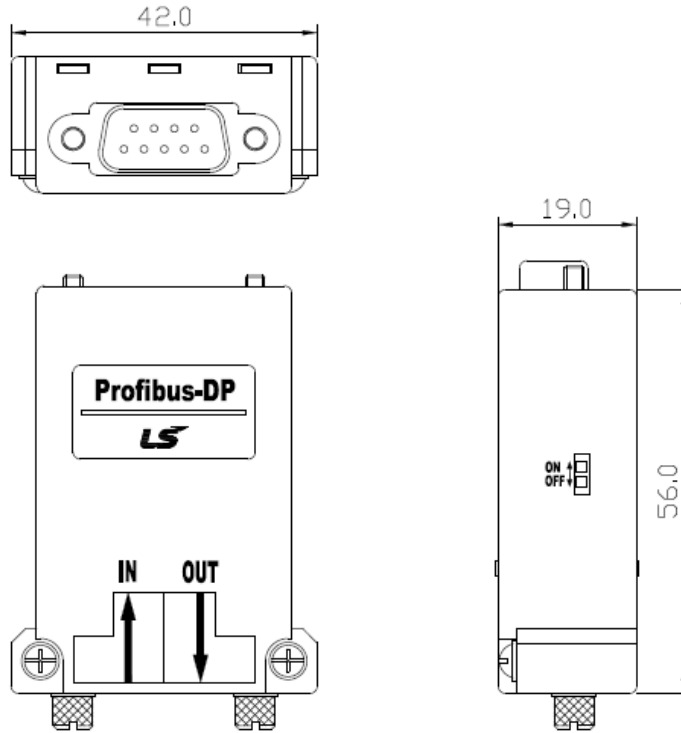

Figure 2 PROFIBUS Connector

PROFIBUS Connector	Pin	Signal	Description
	1	None	None
	2	M24	24 V Output GND
	3	RxD/TxD-P	Received/Transmitted Data - Plus
	4	CTRL-P	Control signal for a repeater
	5	DGND	Signal GND
	6	VP	5 V for termination resistance
	7	P24	24 V Output - Positive
	8	RxD/TxD-N	Received/Transmitted Data - Negative
	9	CTRL-N	Control signal for a repeater

Note) The product supports signal pins 3, 5, 6, and 8 only.

Table 2 Signal Description

2.4 Installation

⚠ Warning

Turn off the inverter before configuring the communication network.

Both the inverter and the communication module will be damaged if the communication module is installed or removed while the inverter is turned on. Install or remove the communication module after the capacitor inside the inverter is completely discharged.

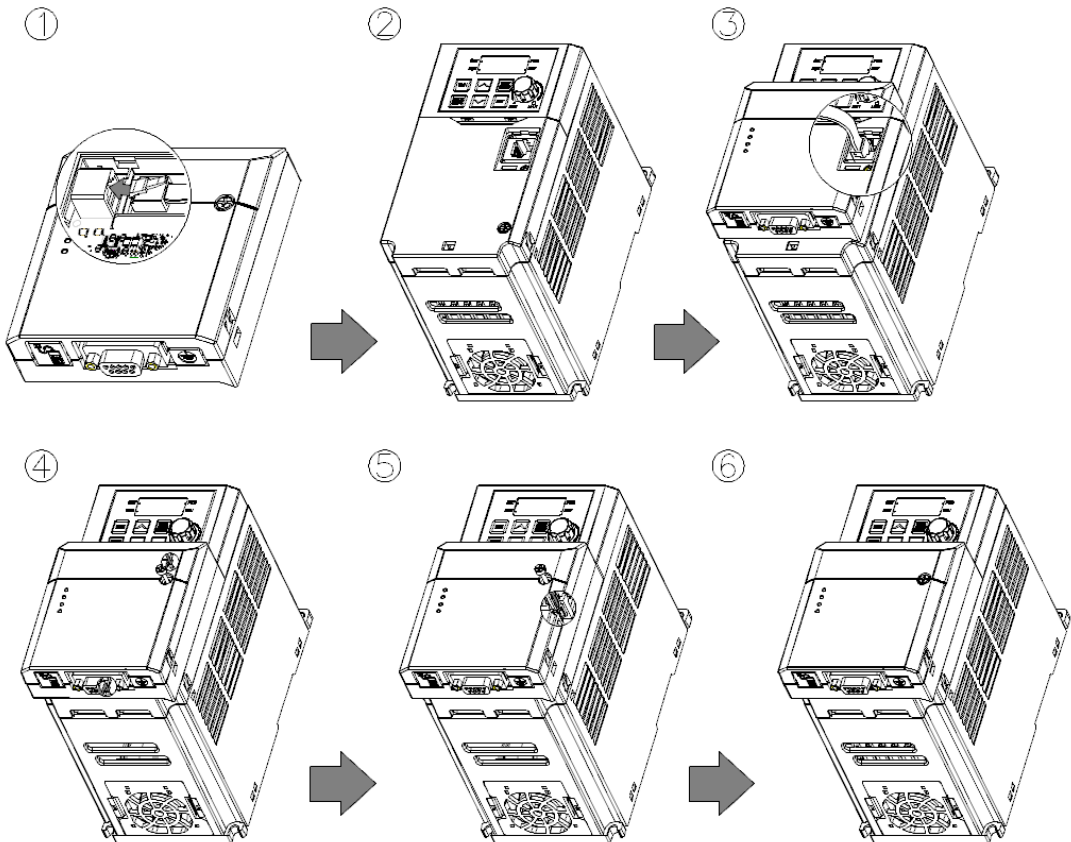

- 1 Get the G100 PROFIBUS-DP communication module ready for installation. (A dedicated RJ-45 cable is attached to the module.)
- 2 Remove the front cover from the G100 inverter.
- 3 Connect the communication module to the G100 inverter using the RJ-45 network cable.
- 4 Hook up the communication module to the installation slot on the inverter.
- 5 Install the fixing bolt provided with the communication module using an appropriate tool.
- 6 The PROFIBUS-DP communication module has been installed on the G100 Inverter.

⚠ Warning

- Do not install or remove the communication module to or from the G100 inverter while the inverter is turned on.
- Install or remove the communication module to or from the G100 inverter only after the electric charge of the capacitor inside the inverter has been completely discharged.
- Ensure that the cable connection between the module and the inverter (dedicated RJ-45 cable) is not loose or disconnected.

Grounding the PROFIBUS-DP communication module

Follow the instructions below to ground the communication module using a ground cable (shielded cable). The ground cable is not included in the product package.

①

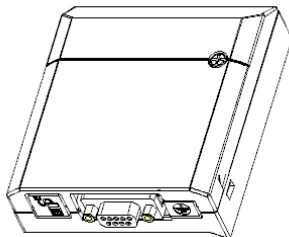

②

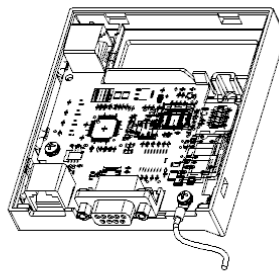

③

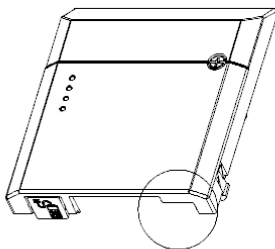

④

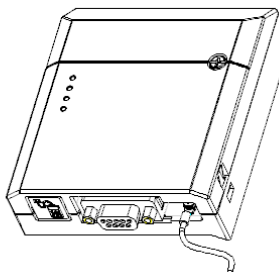

- 1 Remove the front cover from the communication module.
- 2 Fix the ground cable to the communication module using the bottom screw on the circuit board.
- 3 Remove the knockout panel with the grounding symbol from the front cover.
- 4 Install the front cover to the communication module.

2.5 Network Cable Specifications

Item	Description
AWG	22
Cable Type	BC-Bare Copper
Insulation	PE-Polyethylene
Insulation Thickness	0.035 inch
Shield	Aluminum Foil-Polyester, Tape/Braid Shield
Electrostatic Capacity	8,500 pF/ft
Characteristic Impedance	150Ω
Number of Conductors	2 Cores

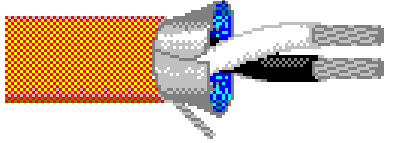

Table 3 Network Cable Specifications

2.6 Network Cable Length by Baud Rate

The total length of a network cable configuration varies depending on the baud rate. The communication quality cannot be guaranteed if the total network cable length exceeds the following cable length limits.

Baud Rate	Max. Segment Length	Max. Extension Length
9.6 kbps	1000 m / 3278 feet	10000 m / 32786 feet
19.2 kbps	1000 m / 3278 feet	10000 m / 32786 feet
93.75 kbps	1000 m / 3278 feet	10000 m / 32786 feet
187.5 kbps	1000 m / 3278 feet	10000 m / 32786 feet
500 kbps	400 m / 1311 feet	4000 m / 13114 feet
1.5 Mbps	200 m / 655 feet	2000 m / 6557 feet
3 Mbps	100 m / 327 feet	1000 m / 3278 feet
6 Mbps	100 m / 327 feet	1000 m / 3278 feet
12 Mbps	100 m / 327 feet	1000 m / 3278 feet

Table 4 Network Cable Length by Baud rate

3 Operation Status and LED Indicators

3.1 LED Indicators

The PROFIBUS DP communication module has 3 LED indicators.

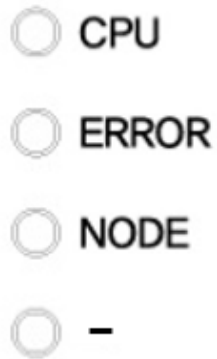

Figure 3 LED Indicators

LED	Color	Description
CPU	Green	Flashes when the communication module is installed to the inverter and the power is supplied.
ERROR	Red	Flashes when a communication module error is detected.
NODE	Green	Turns on when the communication module is online.

Table 5 LED Indicators

3.2 Device Status by Indicator Signal

LED	Status	Operation Status	Possible Cause	Resolution
CPU	Off	Power supply failure	Power has not been provided to the inverter or the PROFIBUS-DP communication module has not been properly installed to the inverter.	Check the power supply to the inverter. Check if the inverter has tripped. Check the connection between the PROFIBUS-DP communication module and the inverter.
	Flashes every second	Normal	Normal operation	
ERROR	Off	Normal	Normal operation	
	Flashes every second (Synchronously with the CPU LED)	Communication error between the module and the inverter	Communication is not available between the inverter and the communication module.	Check if the inverter has tripped. Check the connection between the PROFIBUS-DP communication module and the inverter.
	Flashes at 1 sec intervals (Asynchronously with the CPU LED)	Configuration Error	When the module is operated (online) by a master device, the master device's configuration data is different from the configuration data of the PROFIBUS-DP communication module (Configuration data refers to the number of status and control data.)	Check the configuration data set with the master device and the internal configuration data at the inverter.
NODE	Off	Offline	The master device has not started network communication in the network.	Start the network communication from the master device.
			There is a problem with the communication cable connection.	Check the pin number of the connector for the correct orientation of

Operation Status and LED Indicators

LED	Status	Operation Status	Possible Cause	Resolution
				the cable connection and check the termination resistor configuration.
			A master device does not exist in the network.	A master device has not been assigned, or the master device's station ID has been set incorrectly.
			Station ID has been set incorrectly.	In the configuration tool, check if the station ID assigned for the communication module is identical to the station ID set from the inverter's (using the keypad input). Then, ensure that the station ID is not duplicated in the network.
			Network Configuration Error	Check if the network cable length of the segment exceeds the maximum allowed length. Check if the segment has more than 32 stations (including a repeater). Check if the network has more than 126 stations (including a repeater).
	On	Online	All settings (network and station ID settings, parameters, and configuration) are normal.	

Table 6 Device Status by Indicator Signals

4 Inverter Parameters

4.1 PROFIBUS-DP Communication Parameter List

Code Number	Parameter Name	Default	Setting Range	Description
CM-06	FBus S/W Ver	-	-	Indicates the version of the communication module installed to the inverter.
CM-07	FBus ID	1	1–125	Sets up the station ID for the PROFIBUS-DP communication module.
CM-09	FBus Led	-	-	Shows the LED status on the PROFIBUS-DP Communication module.
CM-30	ParaStatus Num	3	0–8	Set up the number of Status for use.
CM-31	Para Status-1	0x000A	0–0xFFFF	Set up the Status address to be read by the master device.
CM-32	Para Status-2	0x000E	0–0xFFFF	
CM-33	Para Status-3	0x000F	0–0xFFFF	
CM-34	Para Status-4	0x0000	0–0xFFFF	
CM-35	Para Status-5	0x0000	0–0xFFFF	
CM-36	Para Status-6	0x0000	0–0xFFFF	
CM-37	Para Status-7	0x0000	0–0xFFFF	
CM-38	Para Status-8	0x0000	0–0xFFFF	
CM-50	Para Ctrl Num	2	0–8	Set up the number of Control for use.
CM-51	Para Control-1	0x0005	0–0xFFFF	Set up the address for the Controls to be controlled by the master device.
CM-52	Para Control-2	0x0006	0–0xFFFF	
CM-53	Para Control-3	0x0000	0–0xFFFF	
CM-54	Para Control-4	0x0000	0–0xFFFF	
CM-55	Para Control-5	0x0000	0–0xFFFF	
CM-56	Para Control-6	0x0000	0–0xFFFF	
CM-57	Para Control-7	0x0000	0–0xFFFF	
CM-58	Para Control-8	0x0000	0–0xFFFF	
CM-68	FBus Swap Sel	0	0–1	0 : NO 1 : Swap
CM-94	Comm Update	0	0: NO 1: YES	Update keypad parameters related to network communication.

Table 7 Inverter Parameters

4.2 PROFIBUS-DP Communication Parameters

4.2.1 Communication module Version

CM-06 is used to display the version of PROFIBUS-DP communication module installed on the inverter.

4.2.2 Station ID Setting

The following parameters are used to set the Station ID for the PROFIBUS-DP communication module.

CM-07	FBus ID
CM-94	Comm Update

The parameters above are used to set the Station ID for the PROFIBUS-DP communication module. A Station ID can be set to a value within a range of 1–125.

The station ID cannot be duplicated. Make sure the same Station ID is not used by another module in the network.

After changing the Station ID, you must set "CM-94 (Comm Update)" to "1" to apply the change to the PROFIBUS-DP Communication module.

4.2.3 LED Indication for Communication Status

CM-09 is used to indicate the operation status of the three LED indicators (NODE, ERROR, CPU) on the PROFIBUS-DP communication module.

On the keypad display, the status of the 3 LED indicators are displayed, in an order of blank (reserved), NODE, ERROR, and CPU, from left to right.

(Example of an LED indicator status expressed with CM-09)

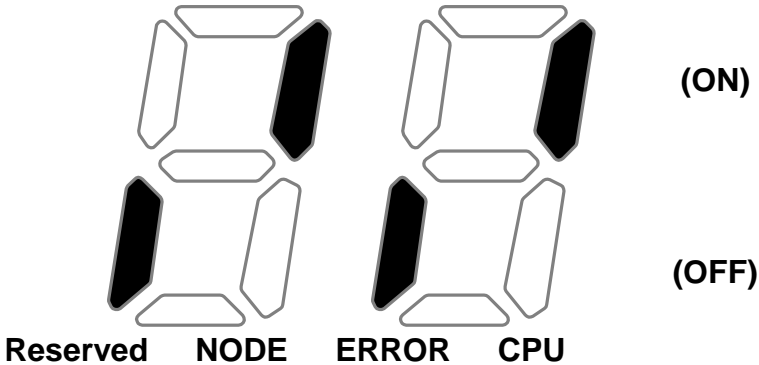

Reserved	NODE (GREEN)	ERROR (RED)	CPU (GREEN)
OFF	ON	OFF	ON

4.2.4 Number of Para Status settings

CM-30	Number of Para Status settings
CM-31 ~ CM-38	Para Status1–8 settings
CM-94	Comm Update

The parameters above are used to determine how much "Para Status" data will be sent to the master device by the inverter through PROFIBUS-DP network communication.

The number of the "Para Status" can be set to a number between 0 and 8.

After setting the number of "Para Status," each "Para Status" has to be set using the matching number of parameters from CM-31 to CM-38. For example, if CM-30 is set to "3," "Para Status" should be set for CM-31 to CM-33. If CM-30 is set to "6," the "Para Status" should be set for CM-31 to CM-36.

After changing the number of "Para Status," you must set "CM-94 (Comm Update)" to "1" to apply the changes to the PROFIBUS-DP communication module.

4.2.5 Para Status 1–8

The following parameters are used to set the Station ID for the PROFIBUS-DP communication module.

CM-30	Number of Para Status settings
CM-31 ~ CM-38	Para Status1–8 settings

The "Para Status" setting defines which status information will be sent to the master device through PROFIBUS-DP network communication.

Para Status 1–8 are set in the form of inverter address.

The inverter's common area and keypad parameter addresses are used as the setting values.

The keypad parameter addresses can be expressed according to the following formula: $0x1000 + (\text{"Group number"} \times 0x100) + (\text{"Code number"})$.

For example, if you want to set "Para Status1" to "In.90 (DI Status)," you can set it as an address, "0x155A."

$$0x1000 + 0x05 \times 0x100 + 0x5A (\text{Dec } 90) = 0x155A$$

Group	Group Number
dr Group	1 (0x01)
bA Group	2 (0x02)
Ad Group	3 (0x03)
Cn Group	4 (0x04)
In Group	5 (0x05)
OU Group	6 (0x06)
CM Group	7 (0x07)
AP Group	8 (0x08)
(Reserved)	9 (0x09)
(Reserved)	10 (0x0A)
PRT Group	11 (0x0B)
M2 Group	12 (0x0C)
SPS Group (Operation Group)	13 (0x0D)

4.2.6 Number of Para Control settings

CM-50	Number of Para Control settings
CM-51 ~ CM-58	Para Control 1–Control 8 settings
CM-94	Comm Update

The parameters above are used to determine how much "Para Control" data will be sent to the master device by the inverter through PROFIBUS-DP network communication.

The number of the "Para Control" can be set to a number between 0 and 8.

After setting the number of "Para Control", each "Para Control" has to be set using the matching number of parameters from CM-51 to CM-58. For example, if CM-50 is set to "2," "Para Control" should be set for CM-51 to CM-52. If CM-50 is set to "5," the "Para Status" should be set for CM-51 to CM-55.

After changing the number of "Para Control," you must set "CM-94 (Comm Update)" to "1" to apply the changes to the PROFIBUS-DP communication module.

4.2.7 Para Control 1–8

CM-50	Number of Para Control settings
CM-51 ~ CM-58	Para Control 1–Control 8 settings

The "Para Control" setting defines which control information will be sent to the master device through PROFIBUS-DP network communication.

Para Control 1–8 are set in the form of an inverter address.

The inverter's common area and keypad parameter addresses are used as the setting values.

The keypad parameter addresses can be expressed according to the following formula: $0x1000 + (\text{"Group number"} \times 0x100) + (\text{"Code number"})$.

For example, if you want to set the jog frequency set "Para Control 1" to "dr-11 (Jog frequency)," you can set it as an address, "0x110B."

$$0x1000 + 0x01 \times 0x100 + 0x0B (\text{Dec } 11) = 0x110B$$

Group	Group Number
dr Group	1 (0x01)
bA Group	2 (0x02)
Ad Group	3 (0x03)
Cn Group	4 (0x04)
In Group	5 (0x05)
OU Group	6 (0x06)
CM Group	7 (0x07)
AP Group	8 (0x08)
(Reserved)	9 (0x09)
(Reserved)	10 (0x0A)
PRT Group	11 (0x0B)
M2 Group	12 (0x0C)
SPS Group (Operation Group)	13 (0x0D)

4.2.8 Comm Update

CM-07	Station ID setting
CM-30	Number of Para Status settings
CM-50	Number of Para Control settings
CM-94	Comm Update

After changing the Station ID, and the number of Para Status and Para Control, set the "CM-94 (Comm Update)" to "1" to apply the changes to the PROFIBUS-DP communication module.

The changes will be applied to the PROFIBUS-DP communication module automatically even if you do not set the "CM-94 (Comm Update)" to "1", and the new setting values will be applied to the PROFIBUS-DP communication module again when "CM-94 (Comm Update)" is set to "1."

4.2.9 Setting PROFIBUS Bit Swap

You can set whether the LSB and MSB bits in the data transmitted during network communication will be swapped.

(This setting is required if the upper-level controller has an interface that reads the LSB and MSB data from the PROFIBUS communication module in a reverse order.)

CM-68	Setting	Keypad Parameter Number
FBus Swap Sel	0: No 1: Yes	CM-68 (Parameter 68 in CM Group)

5 GSD File (Electronic Data Sheets)

A GSD file includes information about the PROFIBUS-DP communication module. The GSD file is required to utilize the PROFIBUS Configuration Software.

You can download the GSD file from the technical support page of LS ELECTRIC website (<https://www.lselectric.co.kr>).

Product Warranty

Warranty Information

After purchasing and installing the product, fill out the following information in detail. This information can be used to get the benefits of a warranty when the product becomes faulty during the warranty period.

Maker	LS ELECTRIC Co., Ltd.	Date of Installation	
Model No.	CPDP-G100	Warranty Period	
Customer Information	Name (or company)		
	Address		
	Contact Info.		
Sales Office (Distributor)	Name (or company)		
	Address		
	Contact Info.		

Warranty Service Information

Warranty period is 12 months after installation or 18 months after manufactured when the installation date is unidentified. However, the guarantee term may vary on the sales term

IN-WARRANTY service information

If the defective part has been identified under normal and proper use within the guarantee term, contact your local authorized LS distributor or LS Service center.