

Right choice for ultimate yield

LSIS strives to maximize customers' profit in gratitude of choosing us for your partner.

iS7 PLC Option User Manual

SV-iS7 PLC Option Card

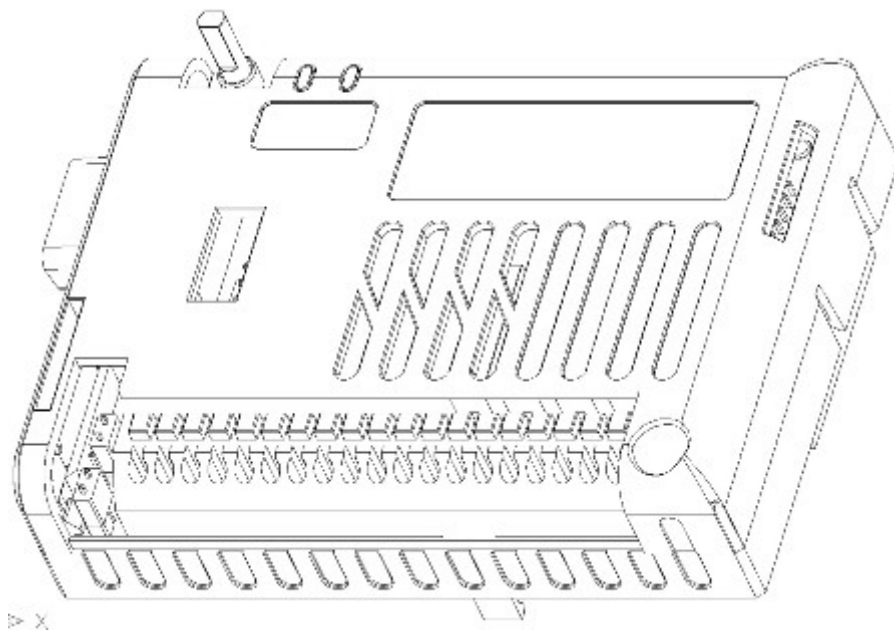

Safety Instructions

- Read this manual carefully before installing, wiring, operating, servicing or inspecting this equipment.
- Keep this manual within easy reach for quick reference.

LS Industrial Systems

Chapter 1 General

1.1 Guide to Use This Manual	1 - 1
1.2 Features	1 - 2
1.3 Terminology	1 - 3

Chapter 2 system Configuration

2.1 Overall System Configuration	2 - 1
2.1.1 Basic System	2 - 1
2.1.2 Product Block Diagram	2 - 2
2.2 Exterior of Product	2 - 3

Chapter 3 General Specification

3.1 General Specification	3 - 1
---------------------------	-------

Chapter 4 CPU Function

4.1 CPU Performance Specification	4 - 1
4.2 Operation Processing	4 - 2
4.2.1 Operation Processing Method	4 - 2
4.2.2 Operation Processing at Momentary Power Failure Occurrence	4 - 3
4.2.3 Scan Time	4 - 3
4.2.4 Scan Watchdog Timer	4 - 4
4.2.5 Timer Processing	4 - 4
4.2.6 Counter Processing	4 - 7
4.3 Program	4 - 9
4.3.1 Classification of Program	4 - 9
4.3.2 Program Execution Procedure	4 - 10
4.3.3 Interrupt Program	4 - 11
4.3.4 Error Handling	4 - 13
4.4 Operation Mode	4 - 14
4.4.1 RUN mode	4 - 14
4.4.2 STOP mode	4 - 15
4.4.3 PAUSE mode	4 - 15
4.4.4 Operation mode change method	4 - 15
4.5 Function	4 - 17
4.5.1 Self-diagnosis	4 - 17

4.5.2 Forced Input/Output On/Off function.....	4 - 17
4.5.3 Direct I/O operation function	4 - 20
4.5.4 System Error History	4 - 20
4.6 Memory Configuration	4 - 22
4.7 RTC Function	4 - 23
4.7.1 Usage.....	4 - 23

Chapter 5 Input and Output Function

5.1 Input and Output Specification	5 - 1
5.2 Digital Input Specification	5 - 2
5.3 Digital Output Specification	5 - 4

Chapter 6 Usage of Various Function

6.1 Built-in Functions	6 - 1
6.1.1 Pulse Catch Function	6 - 1
6.1.2 Input Filter Function	6 - 3
6.1.3 External Interrupt Function.....	6 - 4
6.1.4 PID Control Function.....	6 - 6

Chapter 7 Exclusive Functions for iS7 Inverter Control/Monitoring

7.1 Outline and Installation.....	7 - 1
7.1.1 Outline and Major Components of the Product	7 - 1
7.1.2 Detail description of the components	7 - 3
7.2 Functions of PLC option card exclusively for iS7 inverter	7 - 9
7.2.1 List of the special D registers for iS7 inverter control and monitoring ...	7 - 9
7.2.2 Control (PLC Option → Inverter).....	7 - 10
7.2.3 Monitoring (PLC Option Inverter)	7 - 14

Chapter 8 Modbus Communication

8.1 Modbus Communication.....	8 - 1
8.1.1 Introduction	8 - 1
8.1.2 Basic Specification	8 - 1
8.1.3 Parameter Setting	8 - 4
8.1.4 Instruction	8 - 6

Chapter 9 Maintenance

9.1 Maintenance and Inspection	9 - 1
9.2 Daily Inspection	9 - 1

Chapter 10 Troubleshooting

10.1 Basic Procedures of Troubleshooting	10 - 1
10.2 Troubleshooting	10 - 1
10.2.1 Troubleshooting flowchart used when the ERR LED is flickering	10 - 2
10.2.2 Troubleshooting flowchart used when the RUN LED turns off.	10 - 3
10.2.3 Troubleshooting flowchart used when the I/O part doesn't operate normally	10 - 4
10.2.4 Troubleshooting flowchart used when a program cannot be written to the CPU part	10 - 6
10.3 Troubleshooting Questionnaire	10 - 7
10.4 Troubleshooting and Countermeasure	10 - 8
10.4.1 Input circuit troubles and corrective actions	10 - 8
10.4.2 Output circuit troubles and corrective actions	10 - 9
10.5 Error Code List	10 - 11

Appendix

Appendix 1. System Definitions	Appendix 1 - 1
Appendix 2. Flag List	Appendix 2 - 1
Appendix 3. Control and Monitoring Specific Inverter Data	Appendix 3 - 1
Appendix 4. Common Area Parameter of iS7 Inverter	Appendix 4 - 1

SAFETY INSTRUCTIONS

Before using the product ...

For your safety and effective operation, please read the safety instructions thoroughly before using the product.

- ▶ Safety Instructions should always be observed in order to prevent accidents or risks with the safe and proper use of the product.
- ▶ Instructions are separated into “Warning” and “Caution”, and the meaning of the terms is as follows;

 **Warning** This symbol indicates the possibility of serious injury or death if some applicable instruction is violated

 **Caution** This symbol indicates the possibility of slight injury or damage to products if some applicable instruction is violated

- ▶ The marks displayed on the product and in the user’s manual have the following meanings.

 Be careful! Danger may be expected.

 Be careful! Electric shock may occur.

- ▶ The user’s manual should be kept available and accessible to any user of the product even after it’s been read.

Design Precautions



Warning

- ▶ Install a safety circuit external to the PLC that keeps the entire system safe even when there are problems with the external power supply or the PLC module. Otherwise, serious trouble could result from erroneous output or erroneous operation.

- Outside the PLC, construct mechanical damage preventing interlock circuits such as emergency stop, protective circuits, positioning upper and lower limits switches and interlocking forward/reverse operation.

When the PLC detects the following problems, it will stop calculation and turn off all output in the case of watchdog timer error, module interface error, or other hardware errors.

However, one or more outputs could be turned on when there are problems that the PLC CPU cannot detect, such as malfunction of output device (relay, transistor, etc.) itself or I/O controller. Build a fail safe circuit exterior to the PLC that will make sure the equipment operates safely at such times. Also, build an external monitoring circuit that will monitor any single outputs that could cause serious trouble.

- ▶ Make sure all external load connected to output does NOT exceed the rating of output module.

Overcurrent exceeding the rating of output module could cause fire, damage or erroneous operation.

- ▶ Build a circuit that turns on the external power supply when the PLC main module power is turned on.

If the external power supply is turned on first, it could result in erroneous output or erroneous operation.

Safety Instructions for design process



Caution

- ▶ Do not bunch the control wires or communication cables with the main circuit or power wires, or install them close to each other. They should be installed 100mm (3.94inch) or more from each other.

Installation Precautions



Caution

- ▶ Use the PLC option card in an environment that meets the general specification contained in this manual or datasheet.
Using the PLC option card in an environment outside the range of the general specifications could result in electric shock, fire, erroneous operation, and damage to or deterioration of the product.
- ▶ Completely turn off the power supply before loading or unloading the module.
Not doing so could result in electric shock or damage to the product.
- ▶ Make sure all modules are loaded correctly and securely.
Not doing so could cause a malfunction, failure or drop.
- ▶ Make sure I/O and extension connector are installed correctly.
Poor connection could cause an input or output failure.
- ▶ When install the PLC option card in environment of much vibration, be sure to insulate the PLC option card from direct vibration.
Not doing so could cause electric shock, fire, and erroneous operation.
- ▶ Be sure to there are no foreign substances such as conductive debris inside the module.
Conductive debris could cause fires, damage, or erroneous operation.

Wiring Precautions

Warning

- ▶ Completely turn off the external power supply when installing or placing wiring.
Not doing so could cause electric shock or damage to the product.
- ▶ Make sure that all terminal covers are correctly attached.
Not attaching the terminal cover could result in electric shock.

Caution

- ▶ Be sure that wiring is done correctly by checking the product's rated voltage and the terminal layout.
Incorrect wiring could result in fire, damage, or erroneous operation.
- ▶ Tighten the terminal screws with the specified torque.
If the terminal screws are loose, it could result in short circuits, fire, or erroneous operation.
- ▶ Be sure to ground the FG or LG terminal to the protective ground conductor.
Not doing so could result in erroneous operation.
- ▶ Be sure there are no foreign substances such as sawdust or wiring debris inside the module.
Such debris could cause fire, damage, or erroneous operation.

Startup and Maintenance Precautions



Warning

- ▶ Do not touch the terminals while power is on.
Doing so could cause electric shock or erroneous operation.
- ▶ Switch all phases of the external power supply off when cleaning the module or retightening the terminal or module mounting screws.
Not doing so could result in electric shock or erroneous operation.
- ▶ Do not charge, disassemble, heat, place in fire, short circuit, or solder the battery.
Mishandling of battery can cause overheating or cracks which could result in injury and fires.



Caution

- ▶ Do not disassemble or modify the modules.
Doing so could cause trouble, erroneous operation, injury, or fire.
- ▶ Switch all phases of the external power supply off before mounting or removing the module.
Not doing so could cause failure or malfunction of the module.
- ▶ Use a cellular phone or walky-talky more than 30cm (11.81 inch) away from the PLC option card.
Not doing so can cause a malfunction.

Disposal Precaution



Caution

- ▶ When disposing of this product, treat it as industrial waste.
Not doing so could cause poisonous pollution or explosion.

Chapter 1 General

1.1 Guide to Use This Manual

This manual includes specifications, functions and handling instructions for the PLC option card for dedicated iS7 inverter. This manual is divided up chapters as follows:

No.	Title	Contents
Chapter 1	General	Describes configuration of this manual, unit's for features and terminology.
Chapter 2	System Configuration	Describes available units and system configuration in the iS7 PLC option card.
Chapter 3	General Specification	Describes general specifications of units used in the PLC option card.
Chapter 4	CPU	Describes each kind of Manufactured goods' usage and specifications.
Chapter 5	Input and Output	
Chapter 6	Usage of Various Functions	
Chapter 7	iS7 Inverter Control/Monitoring Function	Describes the most important function which is control/monitoring of PLC option card of iS7 inverter.
Chapter 8	Communication Function	Describes the built-in communication function of PLC option card.
Chapter 9	Maintenance	Describes the items to be checked for long-term normal operation of the iS7 PLC option card.
Chapter 10	Troubleshooting	Describes the various operation errors and corrective actions.
Appendix 1	System Definitions	Describes parameter setting for basic I/O and communications module.
Appendix 2	Flag List	Describes the types and contents of various flags.
Appendix 3	Control and Monitoring Specific Inverter Data	Describes enables control or monitoring of the specific data of inverter.
Appendix 4	Common Area Parameter of iS7 Inverter	Describes the common area parameter of iS7 inverter need ed for control/monitoring of iS7 inverter.

Remark
-. This manual does not describe the programming method. For their own functions, refer to the related user's manuals.

1.2 Features

1) iS7 PLC option card is compact type which is integrated the function of CPU, Input and output, and communication function. PLC option card has features of below described.

(1) High speed processing

High speed processing of 0.1 μ s/Step

(2) Various built-in functions

PLC option card can perform the various system by just using the one option card.

- Fast processing applications
 - Pulse catch: Allows the option card to read a pulse which has a width as small as 10 μ s.
 - External interrupt: Using in various applications with built-in 6 interrupt input that high-priority event which requires immediate responses.
- The input filter function helps to reduce the possibility of false input conditions from external noise, such as signal chattering. The filter time can be programmed from 0 to 1000ms.
- Using RS-232C and RS-485 built-in port, the option card can connect with external devices, such as personal computers or monitoring devices and communicate 1:N with external device.
- Using built-in PID control function, PID control system can be constructed without using separate PID module.

(3) Battery-less

The user's program can be saved permanently without battery, because it is stored in EEPROM.

(4) When program is edited during processing, it is stored in EEPROM automatically.

(5) It supports the Master function at Modbus-RTU protocol.

(6) It can easily do On/Off of the system, using RUN/STOP switch.

(7) it can save the program permanently in EEPROM by easy editing with KGLWIN.

(8) Strong self-diagnostic function

It can detect the cause of errors with more detailed error codes.

(9) It can prevent unintentional reading and writing, using password.

(10) Various program execution functions

External and internal interrupt program as well as scan program can be executed by setting the execution condition. Therefore, user can set various program execution modes.

1.3 Terminology

The following table gives definition of terms used in this manual.

Terms	Definition	Remarks
KGLWIN	A programming and debugging tool for the MASTER-K series. It executes program creation, edit, compile and debugging (A computer software).	-
I/O Image Area	Internal memory area of the CPU module which is used to hold I/O statuses.	-
RTC	Abbreviation of 'Real Time Clock'. It is used to call general IC that contains clock function.	-
Watchdog Timer	Supervises the pre-set execution times of programs and warns if a program is not completed within the pre-set time.	-

Chapter 2 System Configuration

2.1 System Configuration

2.1.1 Basic System

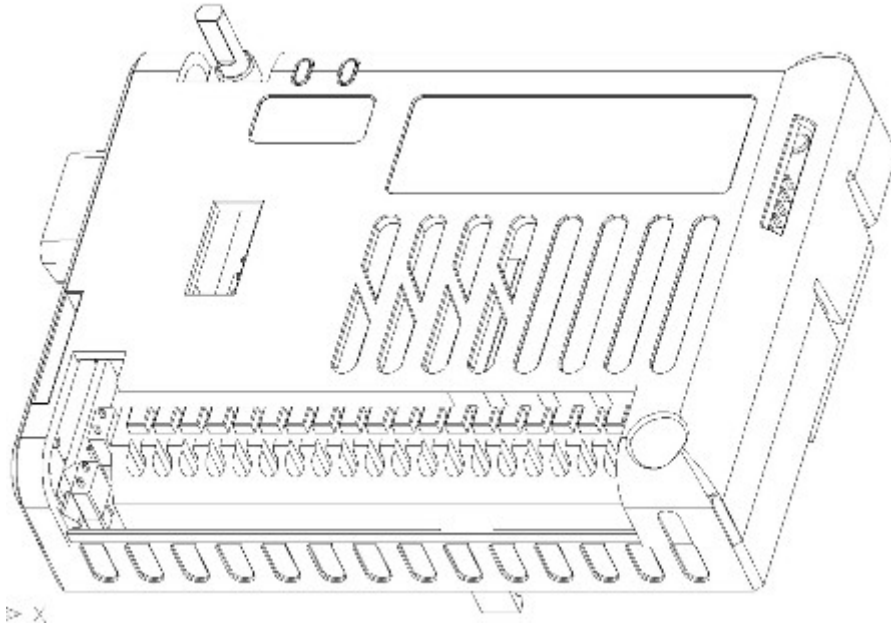

Input points	6 Points (NPN/PNP))
Output points	Relay output 4 points
RS232C	1 port (Program download from KGLWIN)
RS485	1 port (Modbus-RTU Master/Slave)
Display LED	2 ea (Green: RUN LED, Red: ERROR LED)
Switch	3 step switch for RUN, PAU/REM, STOP
Clock function	Built-in RTC (Real Time Clock)
Data Back-up	Data of latch area and RTC data through using CR2032 lithium battery)

Chapter 2 System Configuration

2.1.2 Product Block Diagram

PLC option card for iS7 inverter series' block diagram is as following.

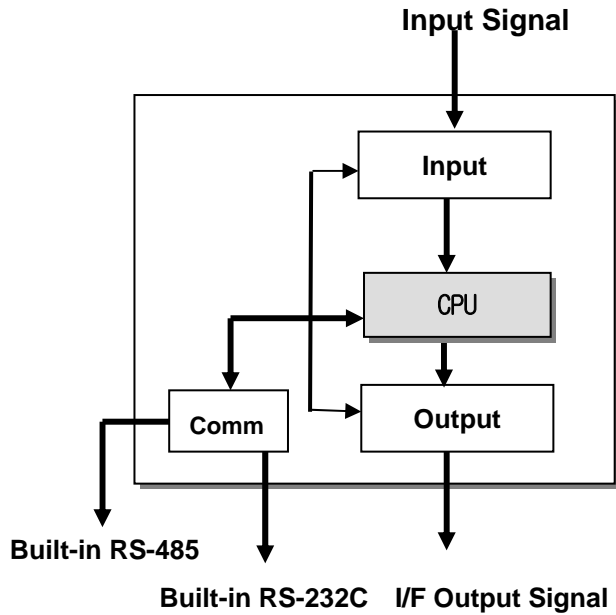

Classification	Main Function
CPU	<ul style="list-style-type: none"> • Signal processing <ul style="list-style-type: none"> - . Operating System function - . Application program saving function - . Data saving function - . Application execution function
Input	<ul style="list-style-type: none"> • Convert the input signal and data to proper signal level from controlled device.
Output	<ul style="list-style-type: none"> • Convert the output signal and data to proper signal level from actuator and display device.
Communication	<ul style="list-style-type: none"> • Configure the 1:1 communication system to connect with PADT (KGLWIN) or built-in RS-232C/RS485 communication.

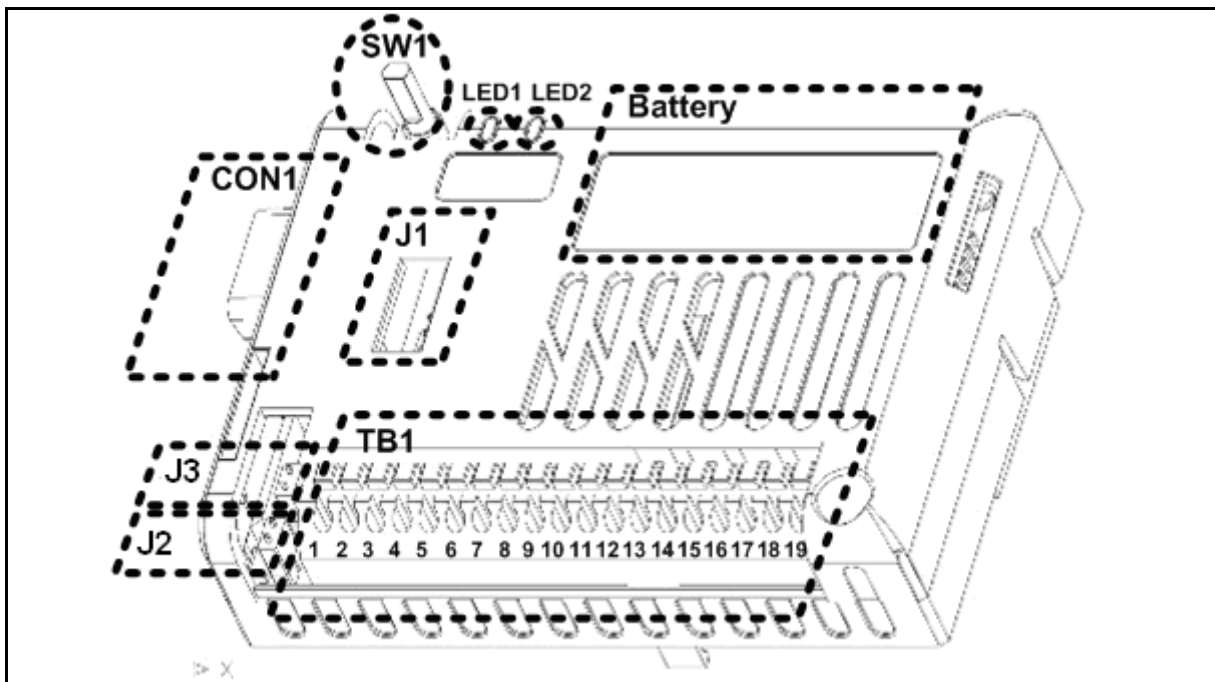

Chapter 2 System Configuration

2.2 Exterior of Product



Symbol	Name	Usage
LED1	RUN LED	On state: Local Run (SW1 position is RUN) or Remote Run (SW1 position is PAU/REM) and Select the RUN icon at KGLWIN.
LED2	ERR LED	1) Flickering : It flickering when Error is occurred. 2) OFF : It is Off at normal operation.
SW1	Mode Switch	1) RUN position : Program Execution 2) PAU/REM position : Temporary stop, Remote Rung/Stop Execution etc. 3) STOP position : Program Stop
J1	PLC OS Download Jumper	1) Factory default state. Do not use other setting. Please contact LSIS customer service center. <div style="display: flex; align-items: center;"> <div style="margin-right: 10px;">BM <input type="radio"/></div> <div style="margin-right: 10px;">5G <input type="checkbox"/></div> <div style="margin-right: 10px;">NON <input type="checkbox"/></div> <div style="margin-right: 10px;">Normal State</div> </div> 2) Do not operate the jumper as below setting. Please contact LSIS customer service center. <div style="display: flex; align-items: center;"> <div style="margin-right: 10px;">BM <input type="checkbox"/></div> <div style="margin-right: 10px;">5G <input type="checkbox"/></div> <div style="margin-right: 10px;">NON <input type="radio"/></div> <div style="margin-right: 10px;">OS Download mode</div> </div>
J2	Terminal Selection Jumper	1) ON: Select the communication terminal resistor of RS485. (Built-in resistor 120 ohm.) 2) OFF: None

Chapter 2 System Configuration

Symbol	Name	Usage	
J3	NPN/PNP Selection jumper	<p>1) NPN mode: Connect terminal input (P00~P05) with 24G.</p>  <p>NPN mode</p> <p>2) PNP mode: Connect the terminal input (P00~P05) with 24P.</p>  <p>PNP mode</p>	
CON1	RS232C communication connector	Connector to communicate with KGLWIN	
Battery	Battery Insertion part	<p>1) Function : Maintaining of the Latch area data and RTC data at power failure</p> <p>2) Battery type: Coin type lithium battery (CR2032)</p> <p>3) Life : about 4 years with power off (normal temperature, capacity 220mAh assumed)</p>	
TB1	Terminal Blcok	1: S+(RS485)	2: S-(RS485)
		3: 24G	4: Terminal InputP00
		5: Terminal InputP01	6: Terminal InputP02
		7: Terminal InputP03	8: Terminal InputP04
		9: Terminal InputP05	10: 24G
		11: 24P (output 24V)	-
		12: Terminal Output P40	13: Terminal Output P40C
		14: Terminal Output P41	15: Terminal Output P41C
		16: Terminal Output P42	17: Terminal Output P42C
18: Terminal Output P43	19: Terminal Output P43C		

Chapter 3 General Specifications

3.1 General Specifications

The following table shows the general specifications of the PLC option card for iS7 inverter series.

No.	Item	Specifications	References			
1	Operating ambient Temperature	0 ~ 55 °C	-			
2	Storage ambient Temperature	-25 ~ +70 °C	-			
3	Operating ambient Humidity	5 ~ 95%RH, non-condensing	-			
4	Storage ambient Humidity	5 ~ 95%RH, non-condensing	-			
5	Vibrations	Occasional vibration		-		
		Frequency	Acceleration	Amplitude	Sweep count	
		10 ≤ f < 57Hz	-	0.075mm		
		57 ≤ f ≤ 150Hz	9.8m/s ² {1G}	-		
		Continuous vibration		10 times for each X, Y, Z axis	IEC 61131-2	
		Frequency	Acceleration			Amplitude
		10 ≤ f < 57Hz	-			0.035mm
		57 ≤ f ≤ 150Hz	4.9m/s ² {0.5G}	-		
6	Shocks	<ul style="list-style-type: none"> Maximum shock acceleration: 147 m/s² {15G} Duration time: 11ms Pulse wave: half sine pulse (3 shocks per axis, on X, Y, Z axis) 	IEC 61131-2			
7	Noise Immunity	Square wave Impulse noise	± 1,500 V	LSIS' Internal Standard		
		Electronic discharge	Voltage: 4 kV (Discharge by contact)		IEC 61131-2, IEC 1000-4-2	
		Radiated electromagnetic field noise	27 ~ 500 MHz, 10 V/m		IEC 61131-2, IEC 1000-4-3	
		Fast transient & Burst noise	Item	Power supply	Digital I/O/Analog I/O Communication Interface	IEC 61131-2 IEC 1000-4-4
Voltage	2kV		1kV			
8	Atmosphere	Free of corrosive gases and excessive dust	-			
9	Altitude	Up to 2,000m	-			
10	Pollution degree	Less than 2	-			
11	Cooling method	Air-cooling	-			

REMARK

- 1) **IEC (International Electrotechnical Commission):** An international civilian institute who establishes international standards in the area of electric and electronics.
- 2) **Pollution degree:** An indicator, which indicates pollution degree, which determine insulation performance of equipment.
 - * **Pollution degree 2:** Normally, only non-conductive pollution occurs. Occasionally, however, a temporary conductivity caused by condensation shall be expected.

Chapter 4 CPU Function

4.1 CPU Performance Specification

The following table shows the general specifications of the PLC option card of iS7 inverter.

Item	Specifications	Remark	
Program Control Method	Cyclic execution of stored program, Time-driven interrupt, Process-driven interrupt	-	
I/O Control Method	Indirect mode(Refresh method), Direct by program command	-	
Program Language	Ladder Diagram Program, Instruction List Program	-	
Number of Instruction	Basic	29	-
	Application	223 Instructions ^(note 1)	-
Program Capacity	2 ksteps	-	
I/O Points	Digital Input 6 points/Digital Output (Relay) 4 points	-	
Memory Device	P	P000 ~ P0005 (External Input), P0040 ~ P0043 (External Output)	I/O Relay
	M	M000 ~ M191F	Internal Relay
	K	K000 ~ K31F	Keep Relay
	L	L000 ~ L63F	Link Relay
	F	F000 ~ F63F	Special Relay
	T	- 100ms: T000 ~ T191 (192 points) - 10ms: T192 ~ T250 (59 points) - 1ms: T251 ~ T255 (5 points), Adjustable by parameter setting	Timer
	C	C000 ~ C255	Counter
	S	S00.00 ~ S99.99	Step Relay
	D	D0000 ~ D4999	Data Register
Operation Methods	RUN, STOP, PAUSE	-	
Self-diagnosis Functions	Detects errors of scan time, memory, I/O and power supply	-	
Data Back-up Method at Power Interruption	Data of Latch and RTC area at basic parameter is reserved when power is turned Off/On with mercury battery (CR2032).	-	
Built-in Function	PID Control Function	Controlled by commands, Relay and PRC auto tuning, PWM output, manual output, adjustable operation scan time, Anti-windup, SV-Ramp, Delta MV, Position and Velocity algorithm	-
	Cnet I/F Function	MODBUS protocol supported (RS-485 1 port)	-
	External Interrupt	6 points	-
	Input Filter	0 ~ 1000 ms (Adjustable via Basic Parameter)	-
	RTC Function	Year/Month/Day/Time/Minute/Second (Available to set by KGLWIN)	-

(note 1) Except for DRCV, DSND, HMDA, HMDAP, HMDB, HMDBP, HSC, HSCST, PLSOUT, POSCTR, POSDST, POSIST, POSJOG, POSORG, POSPRS, POSSOR, POSVEL, PWM, SCAL, SCALP, SND8, SNDCOM Instructions

4.2 Operation Processing

4.2.1 Operation Processing Method

1) Cycle operation

A PLC program is sequentially executed from the first step to the last step, which is called scan. This sequential processing is called cyclic operation. Cyclic operation of the PLC option card continues as long as conditions do not change for interrupt processing during program execution. This processing is classified into the following stages:

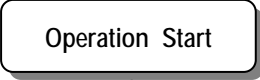
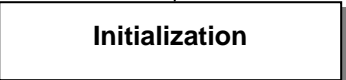
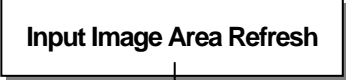
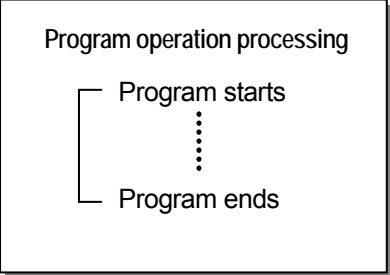
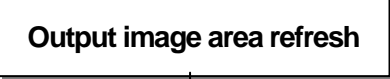
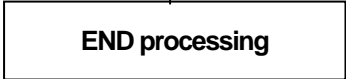
Stages	Processing
	-
	Stage for the start of a scan processing. It is executed only one time when the power is applied or reset is executed. It executes the following processing. <ul style="list-style-type: none"> ▶ I/O reset ▶ Execution of self-diagnosis ▶ Data clear ▶ Allocating I/O address and type
	Input conditions are read and stored into the input image area before it starts processing.
	Program is sequentially executed from the first step to the last step Program operation processing.
	The contents stored in the output image area is output to output part when operation processing of a program is finished.
	Stage for return processing after the CPU part has finished 1 scan. <p>The END processing following processing is executed.</p> <ul style="list-style-type: none"> ▶ Self-diagnosis ▶ Change present values of timer and counter, etc. ▶ Processing data communications between computer link module and communications module. ▶ Checking the switch for mode setting.

2) Interrupt operation method

If a situation occurs which is requested to be urgently processed during execution of a PLC program, this operation method processes immediately the operation, which corresponds to interrupt program. The signal, which informs the CPU of those urgent conditions is called interrupt signal. The CPU has two kinds of interrupt operation methods, which are internal and external interrupt signal methods.

Chapter 4 CPU Function

4.2.2 Operation Processing at Momentary Power Failure Occurrence

The momentary power failure occurs when the input line voltage to the power supply falls down below the rated voltage. When momentary power failure occurs within 10ms, the PLC option card maintain operation processing. But if it exceeds 10ms, PLC option card stops processing and all output turns off. And The re-start process is executed as the power is re-applied.

1) Momentary power failure within 10 ms

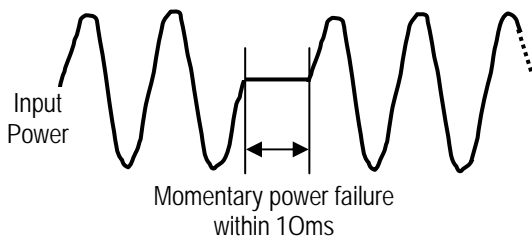

→ The operation processing is maintained.

2) Momentary power failure exceeding 10 ms

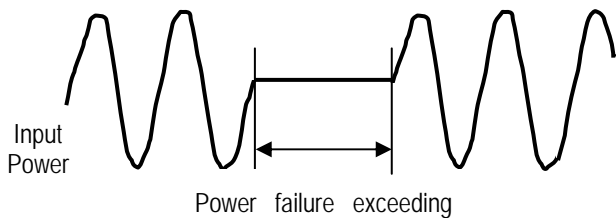

→ The re-start process is executed as the power is re-applied.

Remark

1) Momentary power failure

The PLC option card defining power failure is a state that the voltage of power has been lowered outside the allowable variation range of it. The momentary power failure is a power failure of short interval (several to tens ms).

4.2.3 Scan Time

The processing time from a 0 step to the 0 step of next scan is called scan time.

1) Expression for scan time

Scan time is the sum of the processing time of scan program that the user has written, of the task program processing time and the PLC option card internal processing time.

(1) Scan time = Scan program processing time + Interrupt program processing time +
PLC option card internal processing time

- Scan program processing time = The processing time used to process a user program that is not specified to a task program.
- Interrupt program processing time = Total of the processing time of interrupt programs executed during one scan.
- PLC option card internal processing time = Self-diagnosis time + I/O refresh time + Internal data processing time + Communications service processing time

Chapter 4 CPU Function

- (2) Scan time differs in accordance with the execution or non-execution of interrupt programs and communication processing, etc.

2) Scan time monitoring

Scan time is stored in the following system flag area.

- F50 : Maximum scan time (unit: 1 ms)
- F51 : Minimum scan time (unit: 1 ms)
- F52 : Current scan time (unit: 1 ms)

4.2.4 Scan Watchdog Timer

- 1) Watchdog timer is used to detect a delay which is attributable to abnormal operation of sequence program. (Watchdog time is set in menu of basic parameter of KGLWIN.)
- 2) When watchdog timer detects an exceeding of preset watchdog time, the operation of PLC option card is stopped immediately and all output is off.
- 3) If an exceeding of preset watchdog time is expected in sequence program, use 'WDT' instruction. 'WDT' instruction makes elapsed watchdog time to zero.
- 4) In order to clear watchdog error, restart the PLC option card or change mode to STOP.

Remark

- Setting range of watchdog : 10 ~ 6,000ms (unit : 10ms)

4.2.5 Timer Processing

The PLC option card use up count timer. There are 5 timer instructions such as On-delay Timer (TON), Off-delay Timer (TOFF), Integral (TMR), Monostable (TMON), Retreggerable (TRTG). The measuring range of 100msec timer is 0.1 ~ 6553.5 seconds, 10msec timer is 0.01 ~ 655.35 seconds.

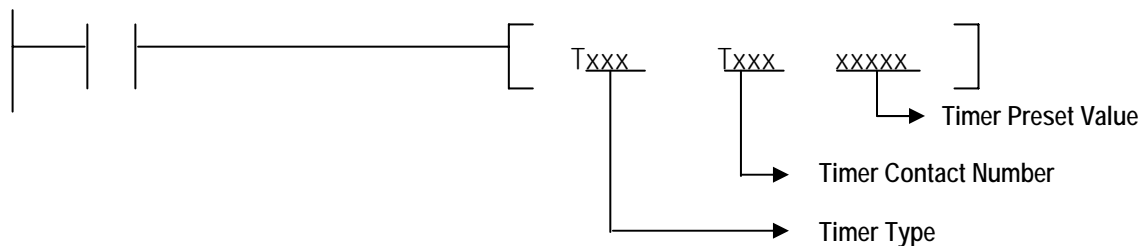

Chapter 4 CPU Function

1) Current value update and Contact On/Off of On Delay Timer

The current value of timer is updated when the input condition of TON instruction turns On. When the current value reaches the preset value (current value = preset value), the timer output relay (Txxx) turns On.

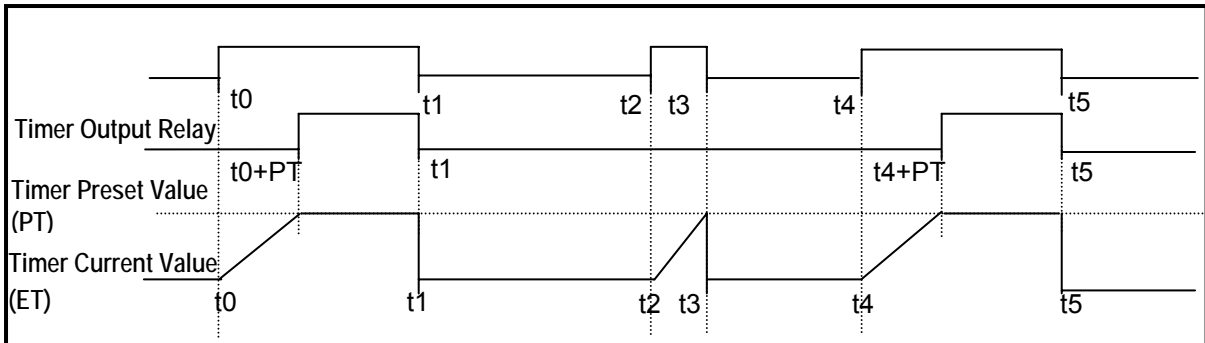

2) Current value update and Contact On/Off of Off Delay Timer

The timer output relay (Txxx) is turned On when the input condition of TOFF is turned On. When the input condition is turned off, the current value starts to decrease. The timer output relay (Txxx) is turned Off when the elapsed time reaches to preset time (current value = preset value). Timer diagram of Off Delay Timer is as below.

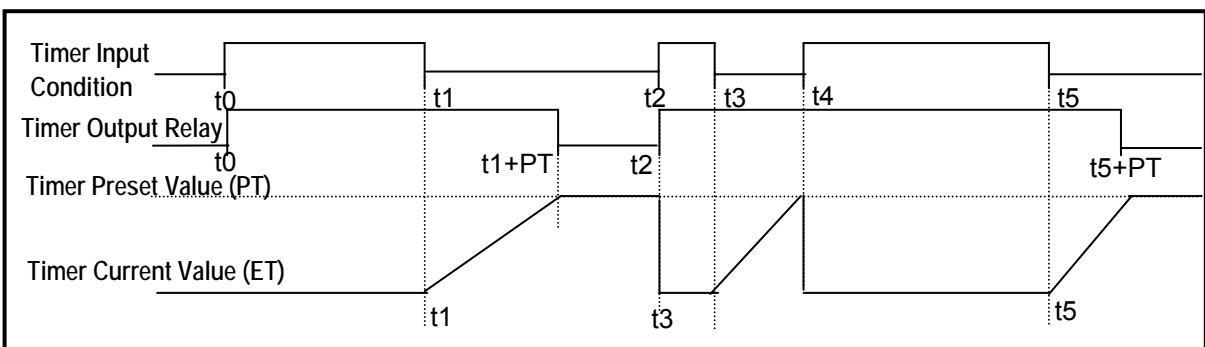

3) Current value update and Contact On/Off of Integral Timer

The current value will be increased when input condition is turned On. Timer output relay is turned On when the current value reaches to timer preset value. Timer output relay turned On keeps the status before reset input is turned On. Timer diagram of Integral timer is as below.

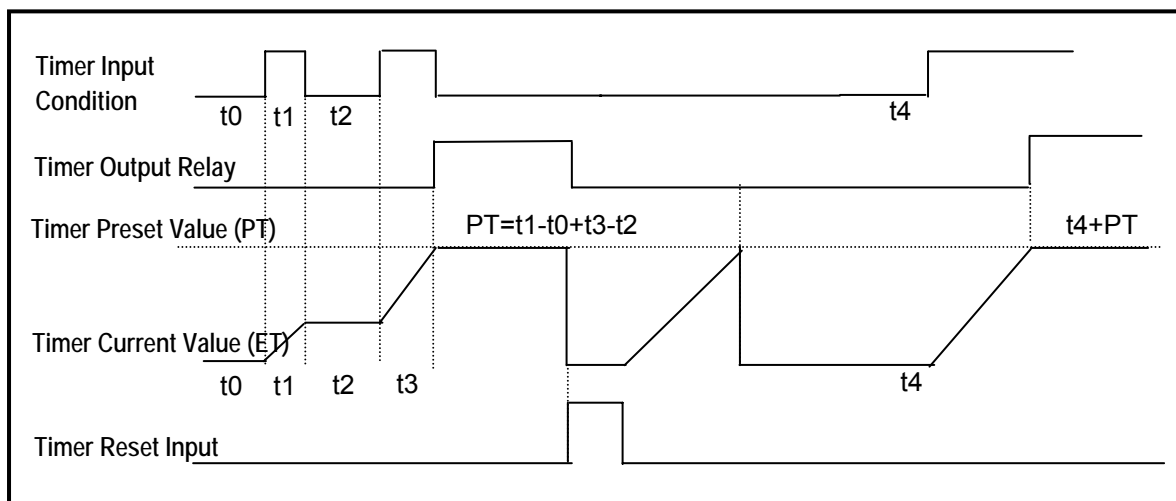

Chapter 4 CPU Function

4) Current value update and Contact On/Off of Monostable Timer

In general, its operation is same as off-delay timer. However, the change of input condition is ignored while the timer is operating (decreasing). When current value reaches preset value the timer output relay is turned off and current value is cleared. Timer diagram of Monostable timer is as below.

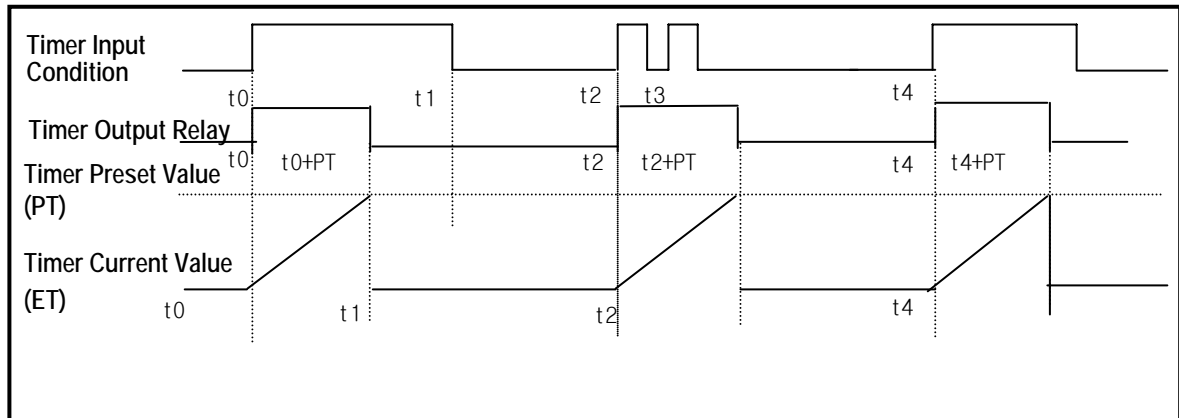

5) Current value update and Contact On/Off of Retriggerable Timer

The operation of retriggerable timer is same as that of monostable timer. Only difference is that the retriggerable timer is not ignore the input condition of TRTG instruction while the timer is operating (decreasing). The current value of retriggerable timer will be set as preset value whenever the input condition of TRTG instruction is turned on.

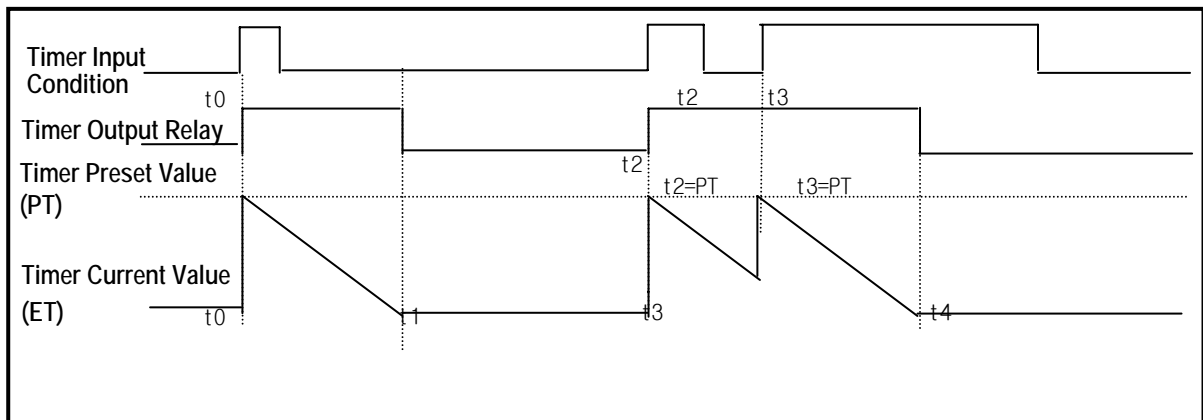

Remark

Timing Error

- The Maximum timing error of timers of PLC option card is '1 scan time + the time from 0 step to timer instruction'

Chapter 4 CPU Function

4.2.6 Counter Processing

The counter counts the rising edges of pulses driving its input signal and counts once only when the input signal is switched from off to on. PLC option card have 4 counter instructions such as Up Counter (CTU), Down Counter(CTD), Up/Down Counter (CTUD), and Ring Counter (CTR). The followings shows brief information for counter operation.

- Up Counter (CTU) increases the current value.
- Down Counter (CTD) decreases the current value.
- Up/Down Counter (CTUD) compares the 2 input conditions' value.
- Ring Counter (CTR) clear the current value as 0 when current value reaches to set value by increasing the current value.

1) Current value update and Contact On/Off

(1) Up Counter

- Input Condition (U), Reset Condition (R), and preset value must be existed.
- The counter output relay is turned on when the current value reaches the preset value.
- When the reset input is turned on, the counter output relay and current value is cleared as 0.



(2) Down Counter

- Input Condition (U), Reset Condition (R), and preset value must be existed.
- When reset signal is turned on, current value reaches to preset value and output relay is turned off.
- The counter output relay is turned on when the current value reaches 0.



(3) Up/Down Counter

- 2 kinds of Input Condition, Reset Condition and Preset Value must be existed.
- When Reset signal is inputted, current value is turned to 0.
- The current value is increased with the rising edge of up-count input signal, and decreased with the rising edge of down-count input signal.
- The counter output relay is turned on when the current value is equal or greater than the preset value otherwise off.



Chapter 4 CPU Function

(4) Ring Counter

- Input Condition (D), Reset Condition (R), and preset value must be existed.
- The current value is increased with the rising edge of the counter input signal, and the counter output relay is turned on when the current value reaches the preset value. Then the current value and counter output relay is cleared as 0 when the next counter input signal is applied.



2) Maximum Counting Speed of Counter

The maximum counting speed of counter is determined by the length of scan time. Counting is possible only when the on/off switching time of the counter input signal is longer than scan time.

Max. Counting Speed $C_{\max} = \frac{n}{100} \times \left(-\frac{1}{t_s}\right)$

n : Duty (%)
t_s : Scan Time [s]

Duty is the ratio of the input signal's on time to off time as a percentage.

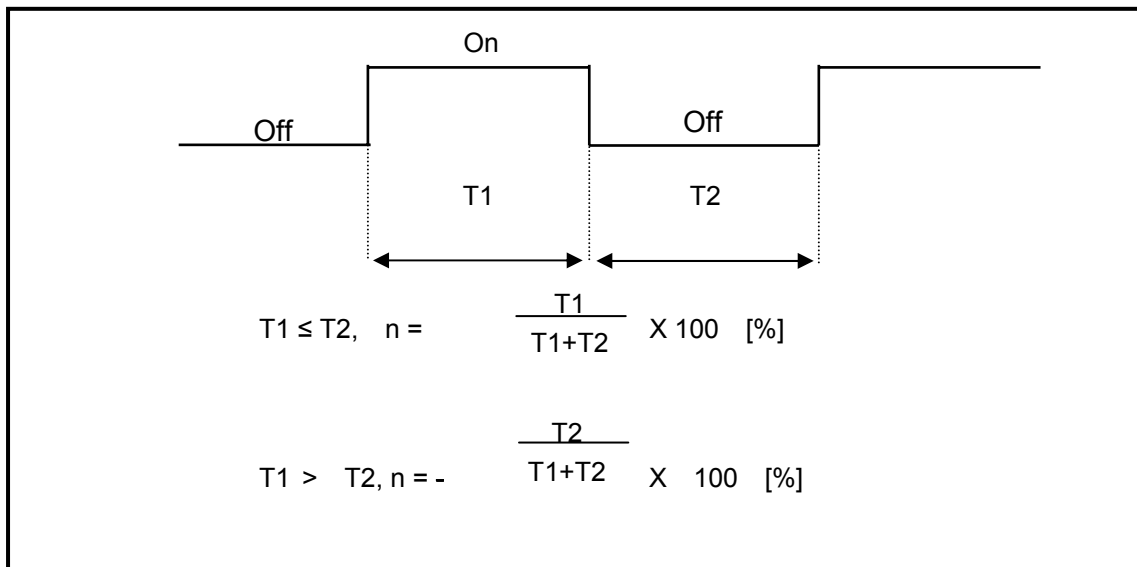

4.3 Program

4.3.1 Classifications of Program

All functional elements need to execute a certain control process are called as a 'program'. In PLC option card, a program is stored in the EEPROM mounted on a CPU module or flash memory of a external memory module. The following table shows the classification of the program.

Program type	Description
Scan program	The scan program is executed regularly in every scan
Time-driven interrupt program (TDI)	The TDI programs are executed with a constant time interval specified with parameter setting as below case. <ul style="list-style-type: none">▶ If process time is needed faster than average 1 scan time,▶ If process time is needed longer than average 1 scan time,▶ If process time is needed with constant time interval,
Process driven interrupt program (PDI)	<ul style="list-style-type: none">• The PDI programs are executed when external interrupt input is applied.
High speed counter driven interrupt program (HSCDI)	<ul style="list-style-type: none">• This interrupt programs are executed when comparison task signal is applied.
Subroutine program	<ul style="list-style-type: none">• The subroutine programs are executed when they are called by the scan program with a CALL instruction.

Chapter 4 CPU Function

4.3.2 Program Execution Procedure

The following diagram shows that how the CPU module process programs when the CPU module is powered on or switched to RUN mode.

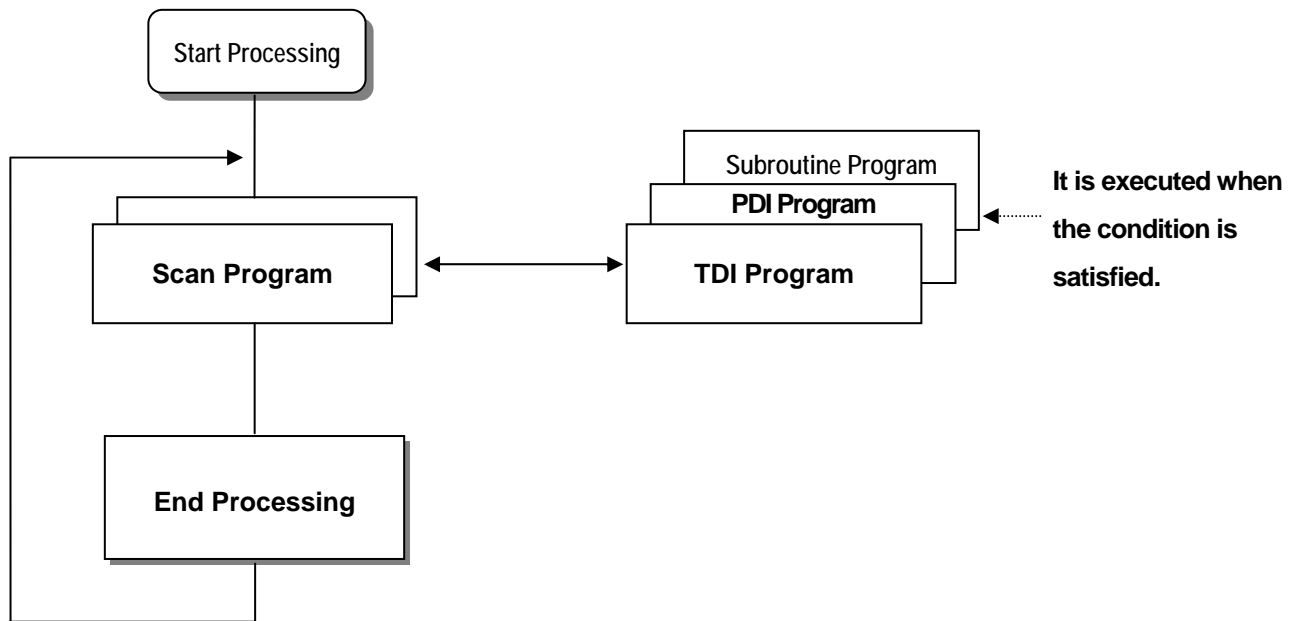

1) Scan Program

(1) Function

- The scan program is executed regularly in every scan from 0 step to last step.
- When interrupts has occurred, CPU pauses scan program and executes corresponding interrupt program first.
- When this interrupt program finished, scan program is to resume.

2) Interrupt Program

(1) Function

- When an interrupt occurs, the CPU module will stop the current operation and execute the corresponding interrupt routine first. After finish the interrupt routine, the CPU resume the sequence program from the stopped step.

(2) Type

- PLC Option card provides 2 types of interrupt.
 - The TDI (Time driven interrupt) occurs with the constant period
 - The PDI (Process driven interrupt) occurs with the status of external input.

4.3.3 Interrupt Program

It describes the program structure of KGLWIN and Interrupt program to help your understanding of Interrupt function of PLC option card . (Please refer to KGLWIN user manual for KGLWIN programming.)

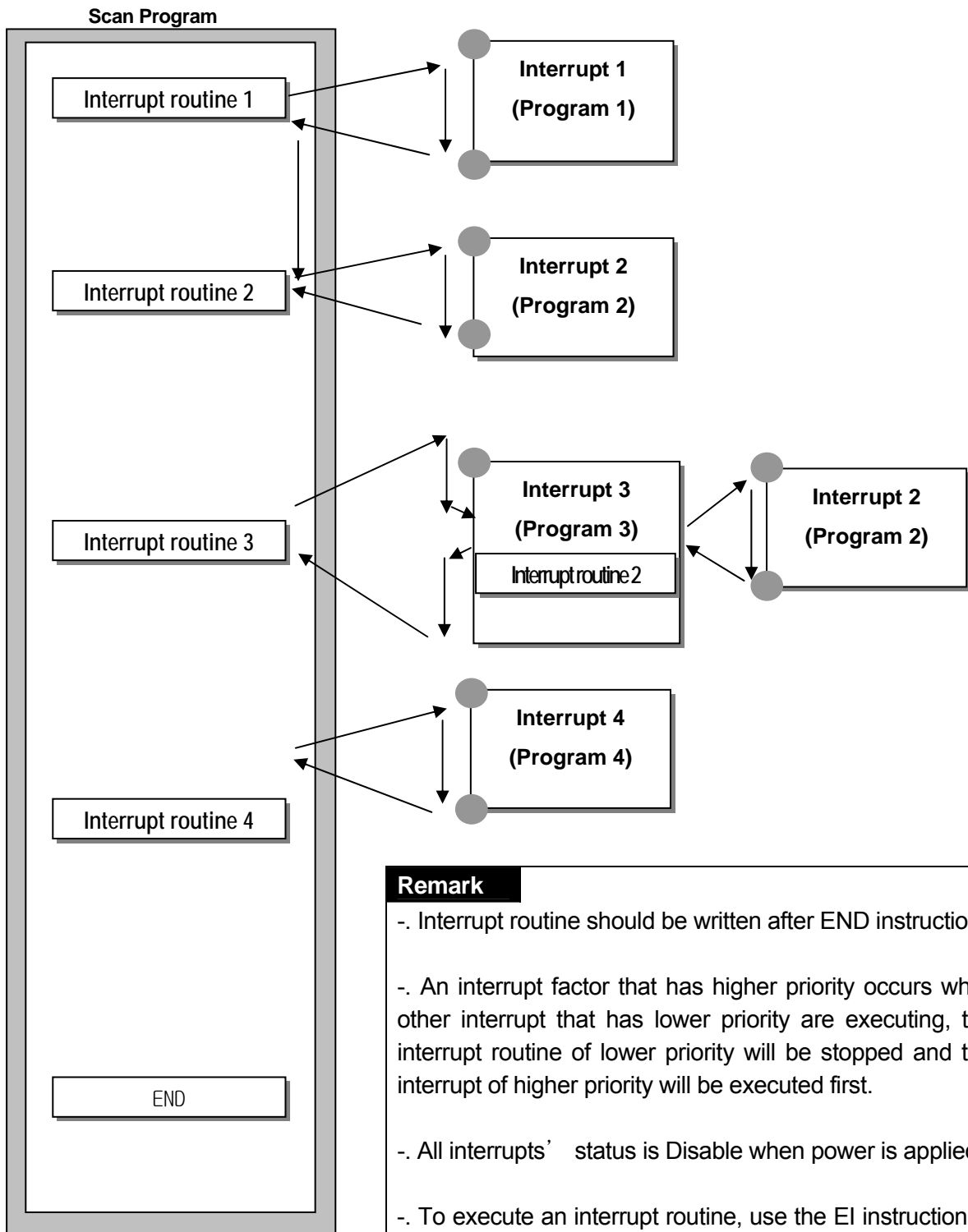

Remark

- . Interrupt routine should be written after END instruction.
- . An interrupt factor that has higher priority occurs while other interrupt that has lower priority are executing, the interrupt routine of lower priority will be stopped and the interrupt of higher priority will be executed first.
- . All interrupts' status is Disable when power is applied.
- . To execute an interrupt routine, use the EI instruction to enable the corresponding interrupt.

Chapter 4 CPU Function

1) Parameter Setting

Parameter [New Project1]							
Basic	Interrupt	CommCh0	CommCh1	PID(TUN)	PID(CAL)	POS	Analog
Priorit...	Interrupt Type	Interrupt No.	TDI Time(10ms)	Contact...	Edge Type	HSC Ch No.	
0	Time Driven	TDINT 0	100				
1	Process D...	INT 1		1	1		

Edit Interrupt [X]

Interrupt Type

Time Driven
 Process Driver
 HSC

Contact No :

TDI Time: * 10 msec

Edge :

HSC Ch No:

* You enable to edit HSC in HSC Parameter.

OK

Cancel

2) Time-driven Interrupt

Time-driven interrupt occurs periodically with the constant interval assigned in parameter setting. In PLC option card of iS7 inverter series, Available TDI is P000 ~ P007 (8 points) assigned in parameter setting and period can be designated for each other.

3) Process-driven Interrupt

Available Process-driven interrupt is P000 ~ P005 (6 points) assigned in parameter setting.

In the parameter setting window, TDINT indicates time driven interrupt and INT indicates process driven interrupt. (Edge setting can select Up, Down, Up/Down of input signal when Process-driven interrupt is selected.)

Remark

- Interrupt signal is ignored when self-interrupt occurs more than 2 times during interrupt processing is executing.

It is ignored. It process the only final signal.

- Interrupt program is available to maximum 8 points. If Process-driven interrupt used one, Time-driven interrupt can use maximum 7 points.

4.3.4 Error Handling

1) Classification of Errors

Errors occur due to various causes such as PLC option card system defect, system configuration fault or abnormal operation result. Errors are classified into fatal error mode, which stops system operation for system stability, and ordinary error mode, which continues system operation with informing the user of its error warning.

The main factors that occurs the PLC option card error are given as followings.

- PLC option card hardware defect
- System configuration error
- Operation error during execution of the user programs
- External device malfunction

2) Operation mode at error occurrence

In case of error occurrence, the PLC option card write the error contents the corresponding flags and stops or continues its operation complying with its operation mode.

(1) PLC option card hardware defect

The system enters into the STOP state if a fatal error such as the CPU module defect has occurred, and continues its operation if an ordinary error such as operation error has occurred.

(2) System configuration error

This error occurs when the PLC option card hardware configuration differs from the configuration defined in the PLC option card. The system enters into the STOP state.

(3) Operation error during execution of the user programs

If the numeric operation error of these errors occurs during execution of the user program, its contents are marked on the error flags and the system continues its operation. If operation time overruns the watchdog time or I/O modules loaded are not normally controlled, the system enters into the STOP state.

(4) External device malfunction

The PLC option card user program detects malfunctions of external devices. If a fatal error is detected the system enters into the STOP state, and if an ordinary error is detected the system continues its operation.

Remark

- 1) In occurrence of a error, the state is to be stored in the representative system error flag F006.
- 2) For details of flags, refer to Troubleshooting.

Chapter 4 CPU Function

4.4 Operation Mode

The CPU operates in one of the three modes - RUN, STOP, and PAUSE mode. The following describes operation processing in each operation mode.

4.4.1 RUN mode

In this mode, programs are normally operated.

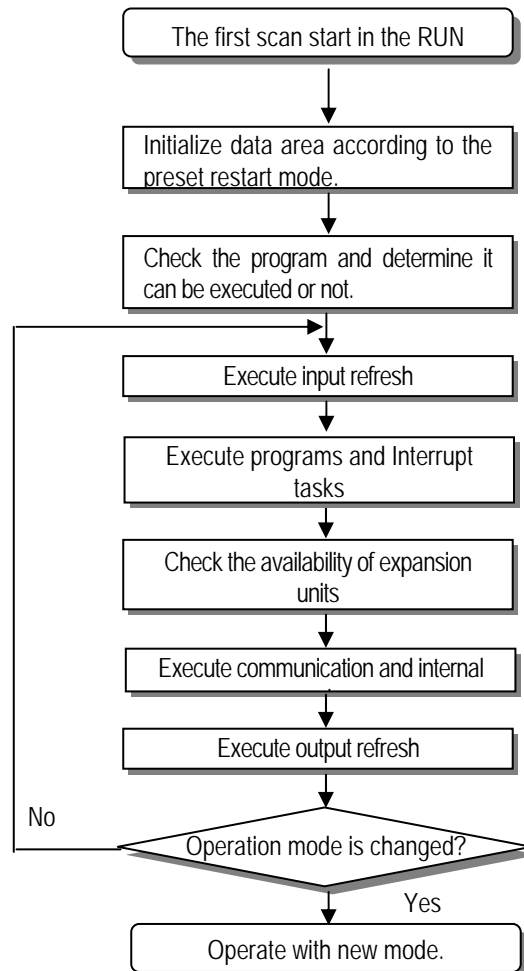

Chapter 4 CPU Function

1) Processing when the operation mode is changed.

Initialization of data area is executed when the first scan starts and The possibility of execution of the program is decided with check on its effectiveness.

2) Operation processing contents

I/O Refresh and program operation are executed.

- (1) Interrupt programs are executed with the detection of their start-up conditions.
- (2) Normal or abnormal operation and mounting conditions of the loaded module are checked.
- (3) Communications service or other internal operations are processed.

4.4.2 STOP mode

In this mode, program are not operated. It can transfer the program via KGLWIN in Remote STOP mode.

In this mode, programs are not operated.

1) Processing when the operation mode is changed.

The output image area is cleared and output refresh is executed.

2) Operation processing contents

- (1) I/O refresh is executed.
- (2) Normal or abnormal operation and mounting conditions of the loaded module are checked.
- (3) Communications service or other internal operations are processed.

4.4.3 PAUSE mode

In this mode, the program operation is temporarily stopped. If it returns to the RUN mode, the operation continues from the state before the stop.

1) Processing when the operation mode changes

Data registers and input image areas are not cleared and the operating conditions just before the mode change is maintained.

2) Operation processing contents

- (1) I/O refresh is executed.
- (2) Normal or abnormal operation and mounting conditions of the loaded module are checked.
- (3) Communications service or other internal operations are processed.

4.4.4 Operation mode change method

1) Operation mode change method

The following method is used to change the operation mode.

- (1) Change by the mode key of the PLC option card for iS7.
- (2) Change by the KGLWIN connected with communication port of PLC option card's CPU.
- (3) Change by the 'STOP' instruction, during program execution.

Chapter 4 CPU Function

2) Operation mode change by mode key

The method of operation mode change by mode key is as below table.

Mode Setting Key Position	Operation Mode
RUN	Local RUN
STOP	Local STOP
PAU / REM	Remote RUN: Select Run icon at KGLWIN Remote STOP: Select STOP icon at KGLWIN Remote PAUSE: Select PAUSE icon at KGLWIN

Remark

If the operation mode changes from RUN mode to local RUN mode by the mode setting key, the PLC option card operates continuously without stopping.

4.5 Function

4.5.1 Self-diagnosis

1) Function

- (1) The self-diagnosis function permits the CPU module of PLC option card to detect its own errors.
- (2) Self-diagnosis is carried out when an error occurs during PLC option card power supply is turned on or operating process. If an error is detected, the system stops operation to prevent faulty PLC option card operation.

2) Watchdog Timer

The watch dog timer is an internal timer of a PLC option card to detect the error of hardware and a sequence program. it is changeable with parameter setting.

The CPU resets the watch dog timer before step 0 is executed (after the END processing is finished). When the END instruction has not been executed within the set value due to an error occurred in the PLC option card or the delay of a sequence program, the watch dog timer will times out. When a watch dog timer error is occurred, all outputs of the PLC option card are turned OFF, and the ERR LED of the CPU will flickers. (RUN LED will be turned OFF) Therefore, when use FOR ~ NEXT or CALL instruction, insert WDT instruction to reset the watch dog timer.

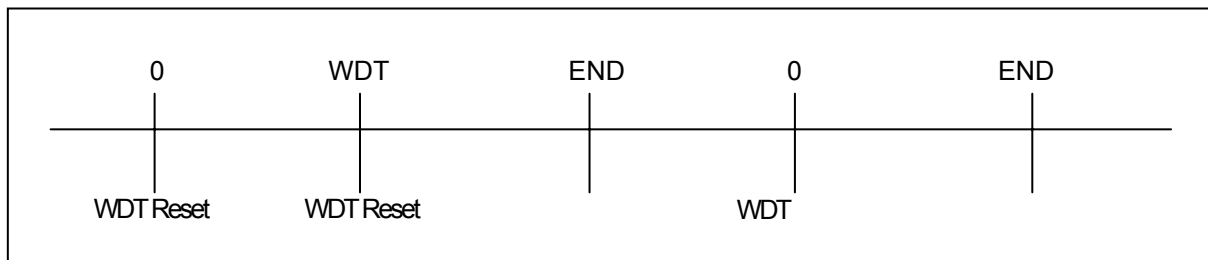

3) Error History

When error occurs in CPU, Corresponding error code is stored in special relay F006.

4.5.2 Forced Input/Output On/Off function

It is possible to input/output a designated data regardless of the program operation results. When used with OUTOFF instruction simultaneously, OUTOFF is prior to Forced I/O On/Off.

1) Forced I/O setting

- . Forced I/O on/off setting is applied to input area and output area.
- . Forced I/O on/off should be set for each input and output, the setting operates from the time that 'Force I/O setting enable' is set.
- . This setting can be done when I/O modules are not really loaded.

Chapter 4 CPU Function

- Select the 'Set forced I/O' from KGLWIN

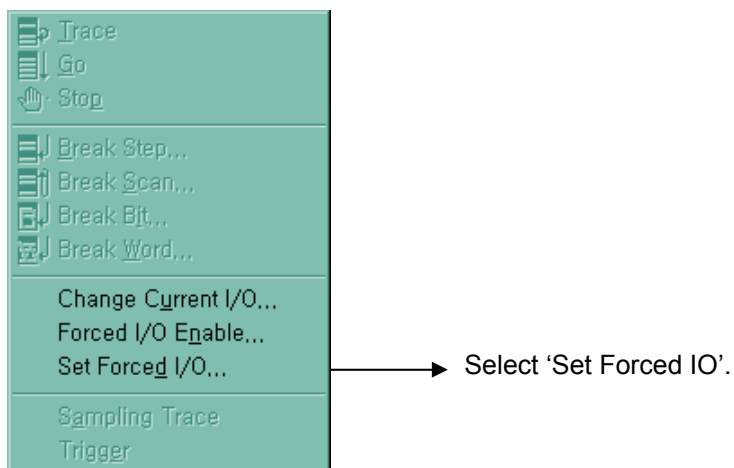

- Select the I/O area and then double click.

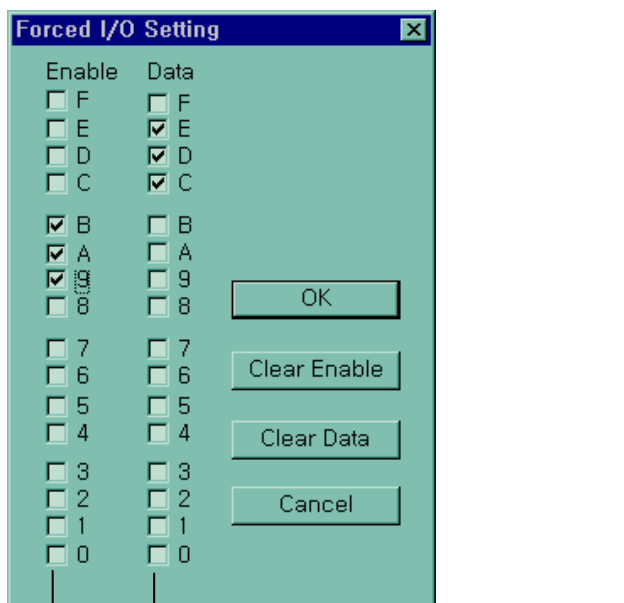
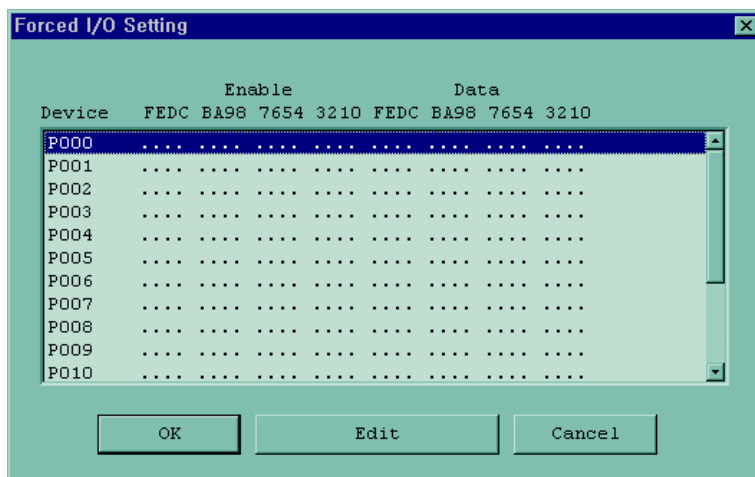

- Set 'forced I/O data' by bit.
- Set 'forced I/O data enable' by bit.

Chapter 4 CPU Function

- When forced I/O set enables, forced I/O function is executing.

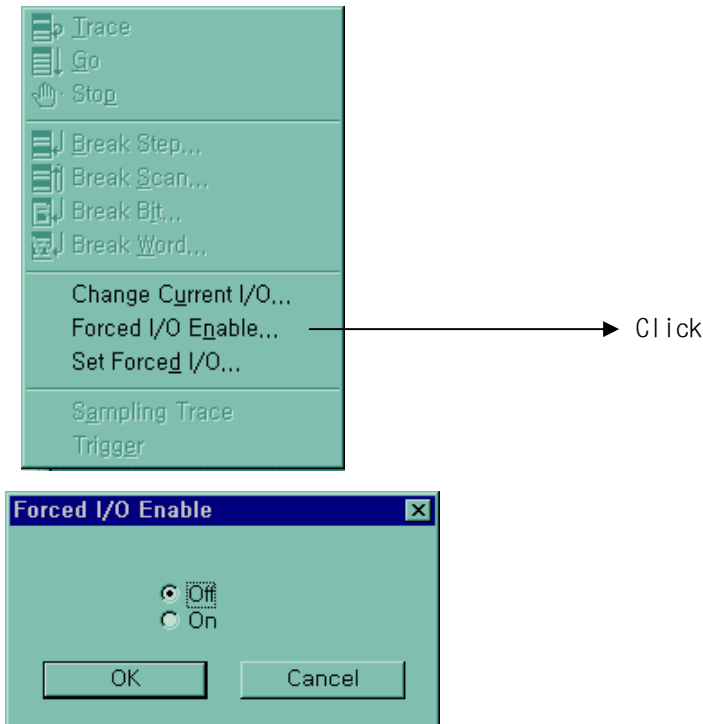

2) Special data register for forced I/O

The contents of forced I/O setting is registered to special data register as below.

It is possible to use 'forced I/O function' to program.

Items	Special Device
All Forced I/O enable	M1910
Forced I/O enable area by bit	D4700 (Contact Input Enable Area) D4704 (Contact Output Enable Area)
Forced I/O set data	D4800 (Contact Input Data Area) D4804 (Contact Output Data Area)

3) Force on/ off Processing timing and method

(1) Forced Input

After data have been read from input modules, at the time of input refresh the data of the junctions which have been set to force on/off will be replaced with force setting data to change the input image area. And then, the user program will be executed with real input data and force setting data.

(2) Force Output

When a user program has finished its execution the output image area has the operation results. At the time of output refresh the data of the junctions which have been set to force on/off will be replaced with force setting data and the replaced data will be output. However, the force on/off setting does not change the output image area data while it changes the input image area data.

Chapter 4 CPU Function

(3) Precaution

- Turning the power off and on, changes of the operation mode or operation by reset switch does not change the previous force on/off setting data. They remain within the CPU module and operation is executed with the same data.
- Forced I/O data will not be cleared even in the STOP mode.
- When setting new data, disable every I/O settings using the setting data clear function and set the new data.

Remark

- For detailed operation, refer to the KGLWIN user's Manual Chapter 7 'Force I/O setting.'

4.5.3 Direct I/O operation function

This function is useful when reads an input relay's state directly during execution of a program and uses in the operation, or write the operation result directly to an output relay. Direct input/output is executed by the 'IORF' instruction. If this instruction is used, the input/output image area will be directly updated and applied to the continuing operations.

4.5.4 System Error History

When the system is stopped by error occurrence, the CPU stores the error occurrence time and error code to the special data register area.

1) Special data register for Error history

The most recent 16 error occurring times and error codes are stored in the special data register. If 17th error is occurred, the first error is erased and 17th error history is stored.

	Area	Error Occurred Point
Error Stored Device	D4901 ~ D4904	The 1 st error information
	D4905 ~ D4908	The 2 nd error information
	:	:
	D4961 ~ D4964	The 16 th error information

2) Description of each word

Data area	Contents	Description
D4900	H0001	Error occurred point
D4901	H0305	Year : 03, Month : 5
D4902	h2812	Date : 28, Hour : 12
D4903	h3030	Minute : 30, Second : 30
D4904	h0001	Error code (h0001)

Chapter 4 CPU Function

3) Clear error data

Use a 'data clear' function of KGLWIN.

REMARK

Refer to the KGLWIN user's Manual Chapter 7, for details.

Chapter 4 CPU Function

4.6 Memory Configuration

The CPU module includes two types of memory that are available by the user. One is program memory, which is used to store the user programs written to implement a system by the user. The other is data memory, which stores data during operation.

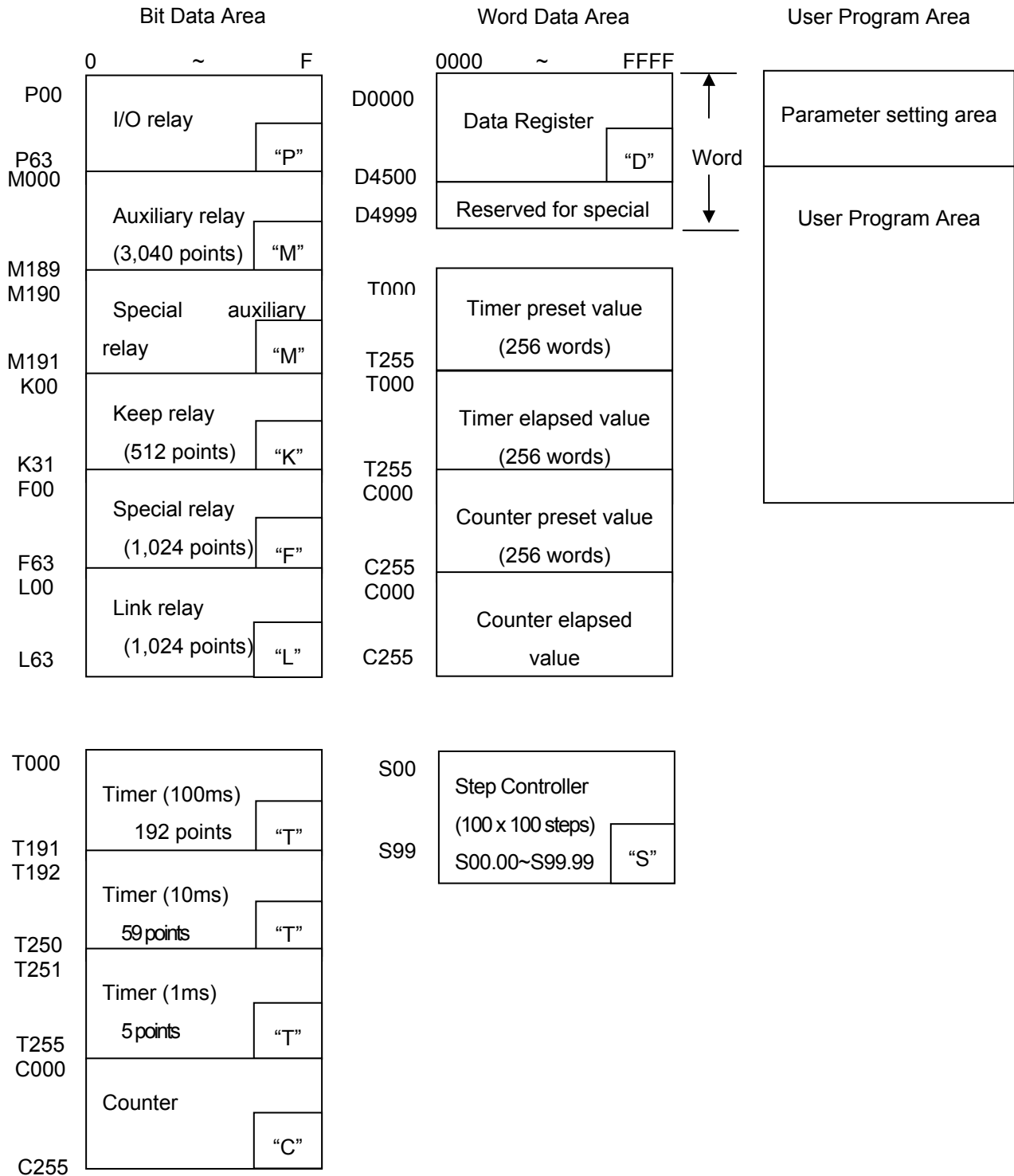

Chapter 4 CPU Function

4.7 RTC Function

PLC option card for iS7 inverter series supplies RTC(Real Time Clock) module for the time-scheduling control. Clock operation by the RTC function is continued with a super capacitor when the CPU is powered off. The time of RTC is updated in every scan by operation information of system flag.

4.7.1 Usage

1) Read/Setting of RTC data

1) Read RTC data

(1) Read RTC data from KGLWIN

- Select **Online –Write Information – Set PLC Clock** in menu.

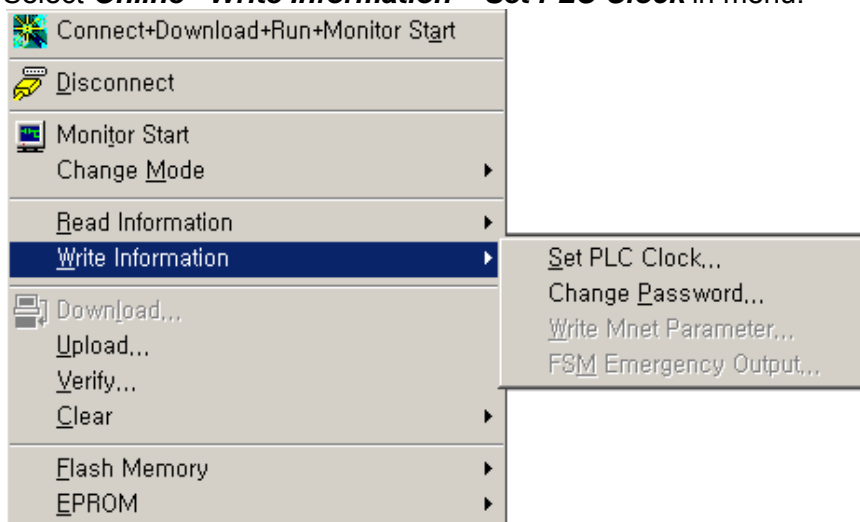

Following message box will be displayed.

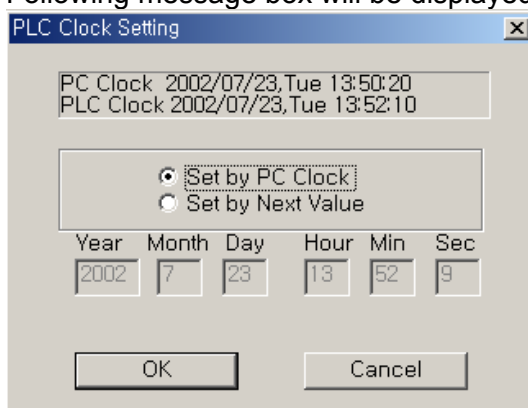

Chapter 4 CPU Function

(2) Read RTC data from special register

The followings are the memory address of preset data.

Special register Area (Word)	Description		Data (BCD format)
	Upper byte	Lower byte	
F053	Lower 2 digits of year	Month	H0207
F054	Day	Hour	H2313
F055	Minute	Second	H5020
F056	Higher 2 digits of year	Date	H2002

Example : 2002. 07. 23. 13:50:20, Tuesday

(3) Date expression

Number	0	1	2	3	4	5	6
Date	Sunday	Monday	Tuesday	Wednesday	Thursday	Friday	Saturday

2) Time Error

±5 second / 1 month

Remark

- 1) If RTC stops or error occurs, write new data to the RTC then error is called off.
- 2) There is no written clock data in the RTC when shipped.
- 3) Before using RTC module, write clock data to the RTC first.
- 4) If the range of time is exceeded, RTC is not operated. Ex)14 month 32 day 25 hour

Chapter 5 Input and Output Function

5.1 Input and Output Specification

Digital input that PLC option card of iS7 inverter offers are made to use both electric current sink and electric current source. (NPN/PNP types) To keep using the coil load as an output module, maximum opening and shutting frequency is 1 second On and 1 second Off. The following diagram shows maximum life relay for relay output.

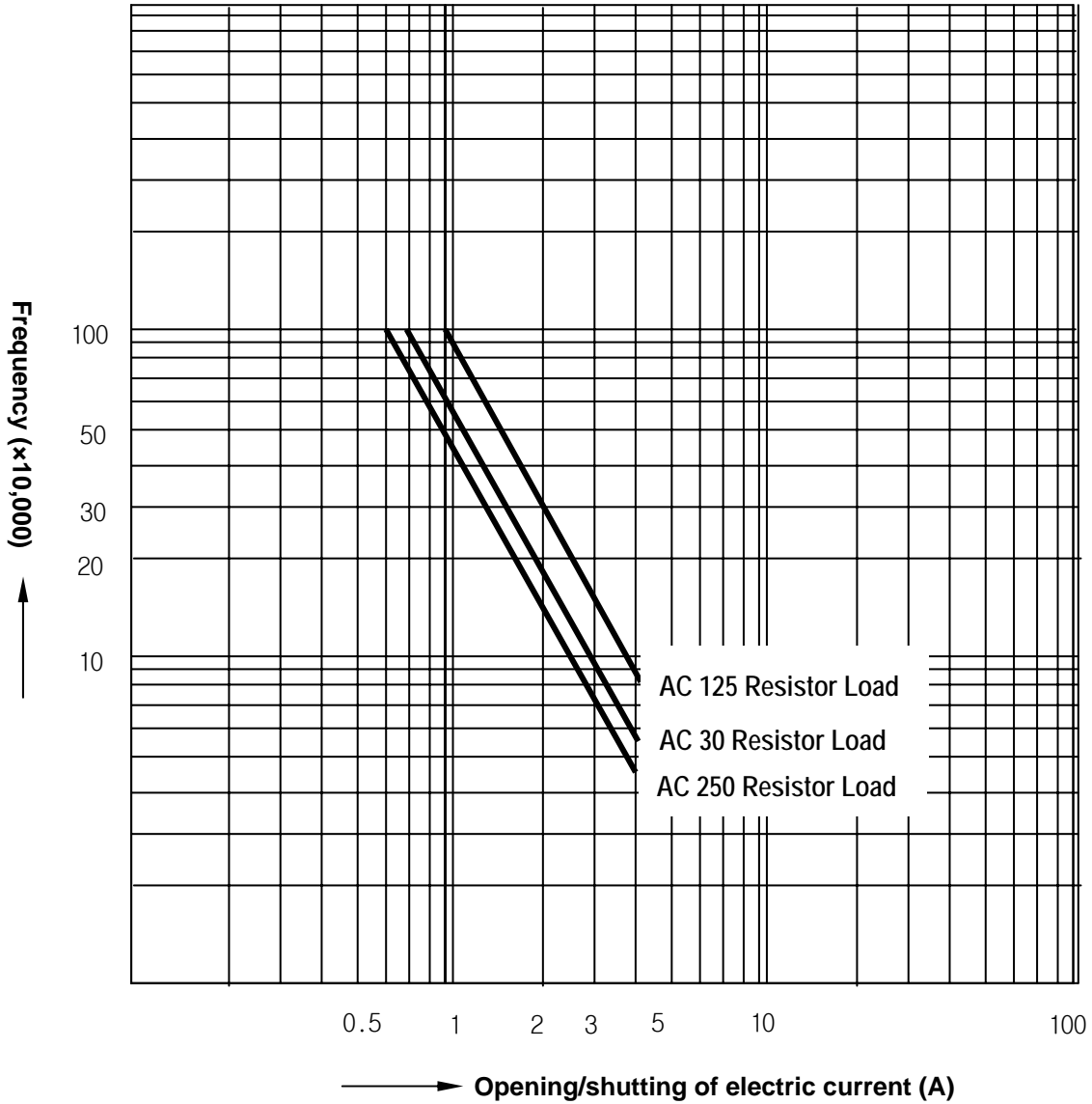

Chapter 5 Input and Output Function

5.2 Digital Input Specification

1) Specification

Model		PLC Option Card of iS7 Inverter
Specification		
Number of Input Points		6 Points
Insulation Methods		Photo-coupler Insulation
Rated Input Voltage		DC24V
Rated Input Current		7mA
Operating Voltage Range		DC20.4 ~ 28.8V (Ripple: less than 5%)
Max. simultaneous input points		100% simultaneously On
On Voltage / On Current		DC19V or higher / 5.7 mA or higher
Off Voltage / Off Current		DC6V or lower / 1.8 mA or lower
Input Impedance		About 3.3 kΩ
Response	Off → On	15ms or less ^(note1)
Time	On → Off	15ms or less ^(note1)
Common Terminal		6 points / COM

^(note1) It can be set from 0 ms to 1000 ms at KGLWIN.

2) Input circuit diagram

PLC option card wiring method is as follows. DC input specifications offered by PLC option card is to be used for both electric current sink and electric current source. Detailed description of terminal block TB1 of product is as below figure.

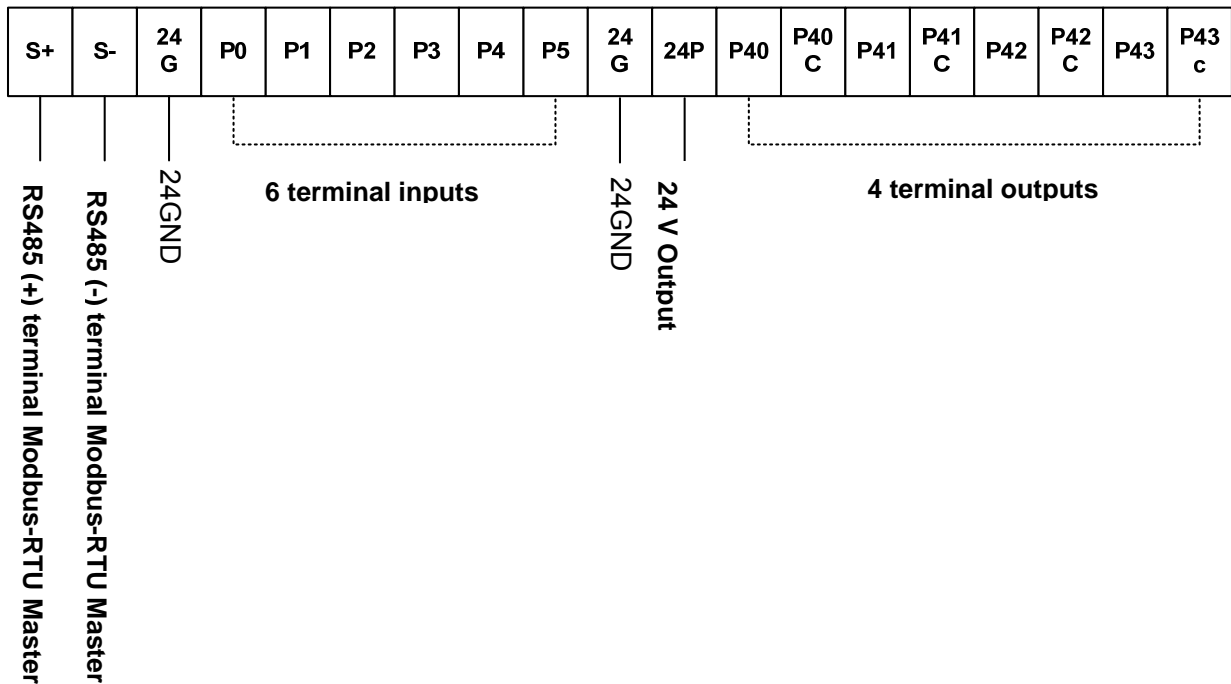

Chapter 5 Input and Output Function

This product provides the six terminal inputs P00~P05 of external terminal block (TB1).

◆ NPN mode

1) Set the J3 (NPN/PNP selection jumper) as below figure.

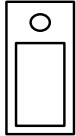

Terminal input is operated to NPN type.

2) Wire the external terminal block (TB1) as below figure. P0 wiring is a sample wiring. Please do wire P1~P5 terminal as same method.

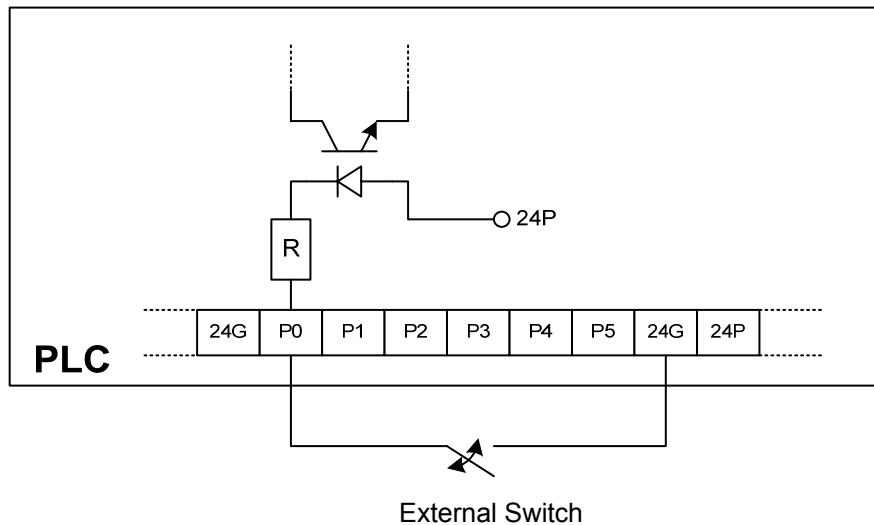

◆ PNP mode

1) Set the J3 (NPN/PNP selection jumper) as below figure.

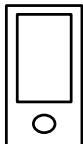

Terminal input is operated to PNP type.

2) Wire the external terminal block (TB1) as below figure. This products can output the 24V as below figure. P0 terminal is wired with 24 V output. Please do wire P1~P5 terminal as same method

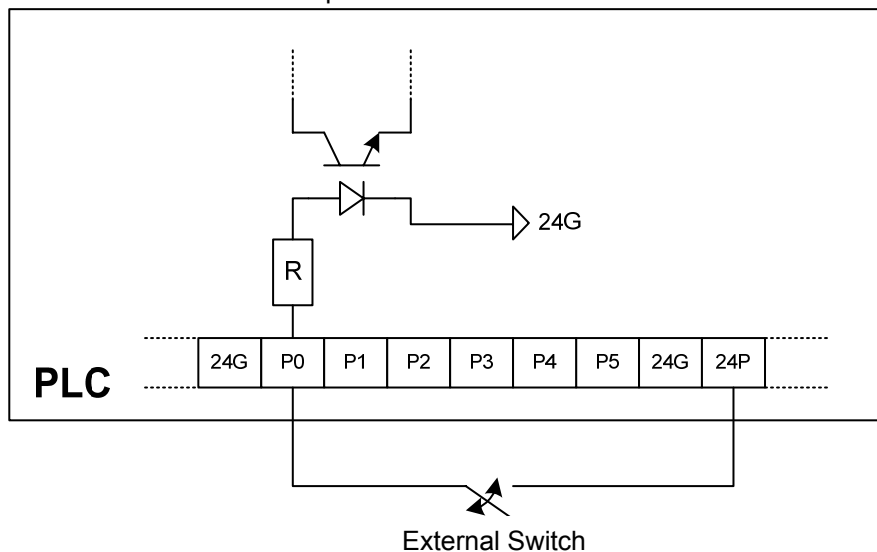

Chapter 5 Input and Output Function

5.3 Digital Output Specification

1) Specification

Model		PLC Option Card of iS7 Inverter
Specification		
Output Points		4 points
Insulation Method		Relay Insulation
Rated Load Vol./Cur.		DC24V / 2A (resistor load), AC220V / 2A (COS Ψ = 1) /1 point 5A/COM
Min. Load Vol./Cur.		DC5V / 1mA
Max. Load Vol./Cur.		AC250V, DC110V
Current leakage when off		0.1mA (AC220V, 60Hz)
Max.On/Off Frequency		1,200 times / hour
Surge Absorber		None
Life	Mechanical	More than 20,000,000
	Electrical	Rated on/off voltage/current load 100,000 or more
		AC200V / 1.5A, AC240V / 1A (COSΨ = 0.7) 100,000 or more
		AC200V / 1A, AC240V / 0.5A (COSΨ = 0.35) 100,000 or more
		DC24V / 1A, DC100V / 0.1A (L / R = 7ms) 100,000 or more
Response Time	Off → On	10 ms or less
	On → Off	12 ms or less

2) Output circuit wiring

PLC option card wiring method is as follows. Total four output terminals (Relay output) P40~P43 of external terminal block (TB1) can be used.

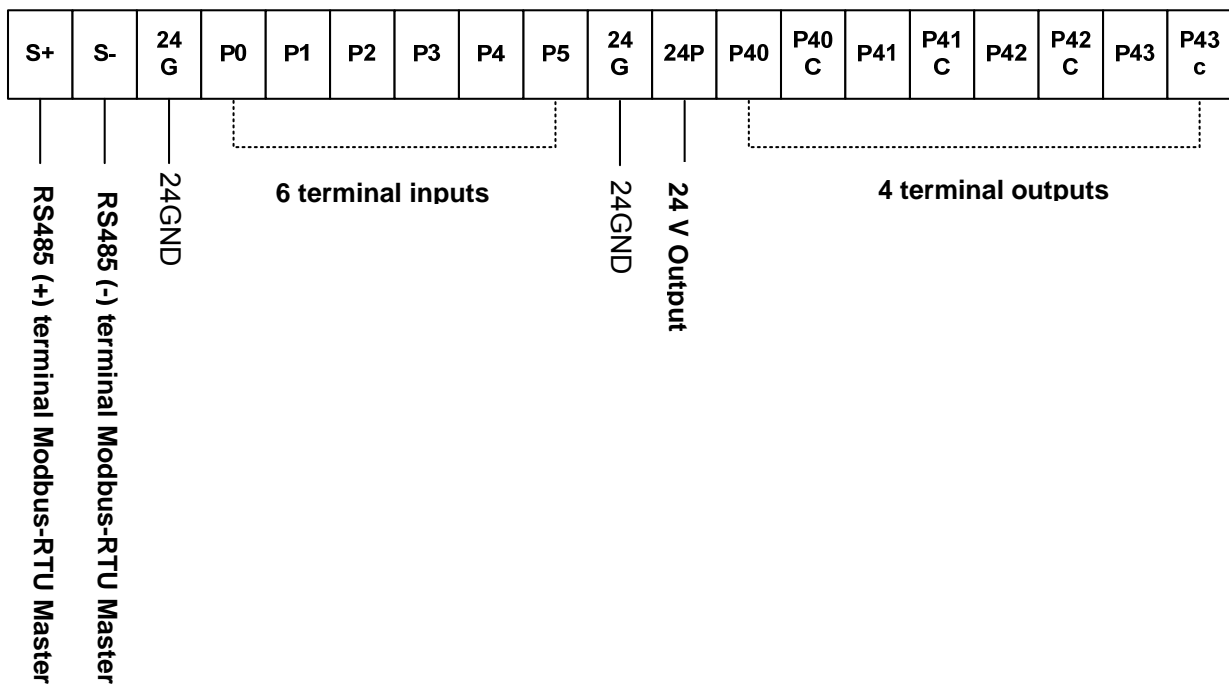

Chapter 5 Input and Output Function

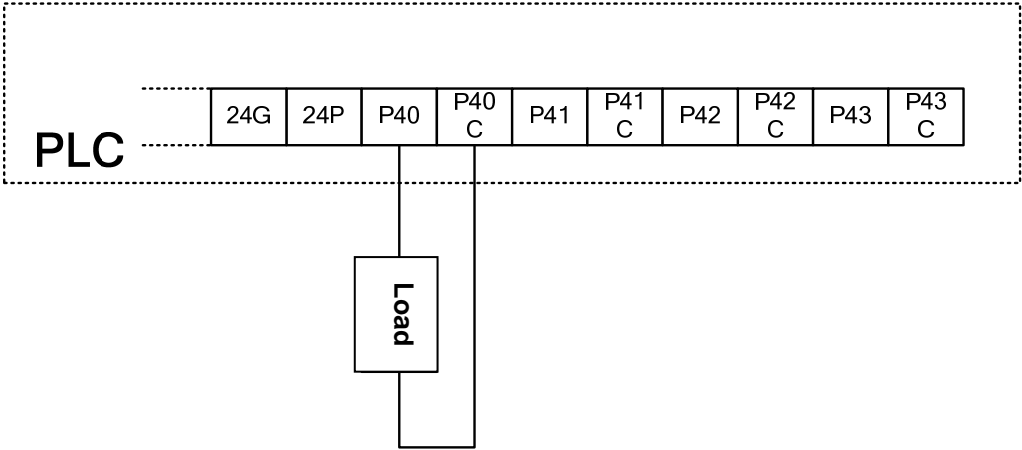

Chapter 6 Usage of Various Functions

6.1 Built-in Functions

6.1.1 Pulse Catch Function

In the main unit, 6 points (P0000~P0005) of pulse catch input contact points are internalized. Through using this contact point, 150 μ s, short pulse signal, can be taken which can not be executed by general digital input.

1) Usage

When narrow width of pulse signal is input, a trouble occurs which can not be detected by general digital input, so the operation does not perform as user's intention. But in this case through pulse catch function even narrow interval of pulse signal as 150 μ s min. can be detected.

2) Minimum input pulse width.

P0000 ~ P0005 : 150 μ s

3) Operating Explanation

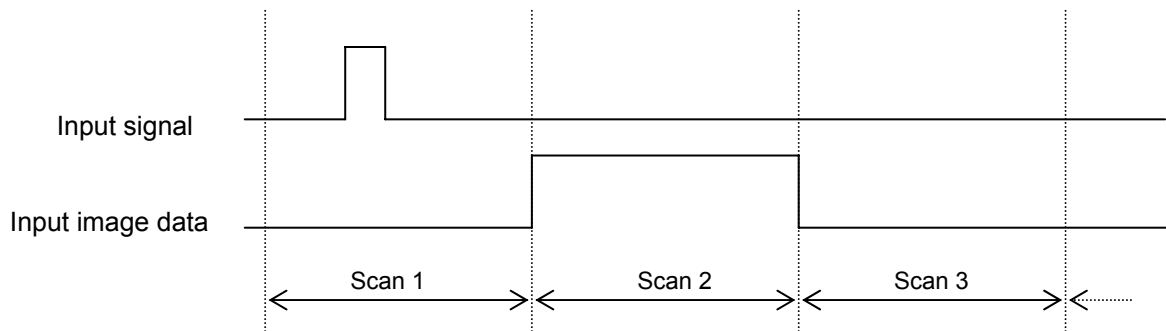

Step	Executing Contents
scan1	CPU senses input when pulse signal, min. 150 μ s, is input, then saves the status.
scan2	used to turn on the region of input image
scan3	used to turn off the region of input image

4) Using Method

- (1) Click the basic parameter twice on the project window of KGLMIN
- (2) Select no. to use for pulse catch input of the basic parameter window.

For details of KGLWIN refers to the manual.

Chapter 6 Usage of Various Functions

Parameter [New Project1]

Basic Interrupt CommCh0 CommCh1 PID(TUN) PID(CAL) **P O S** Analog HSC

Latch Area

L: *** - ***

M: **** - ****

100 msec 144 - 191

10 msec 240 - 250

1 msec 251 - 255

C: 192 - 255

D: 3500 - 4500

S: 80 - 99

Timer Boundary

100 msec 000 - 191

10 msec 192 - 250

1 msec 251 - 255

Watchdog Time: 20 x10ms

PLC Operation Mode

Blown Fuse

Operation Error

Output during

Remote Access Control

Input Setting

Input Filter Time (ms) :

Basic Unit

P0000 - P0007 10

P0008 - P000F 10

P0010 - P0017 10

P0018 - P001F 10

P0020 - P0023 10

extended Module 10

Pulse Catch Set (P000X)

0 1 2 3

4 5 6 7

Remark

- 1) Pulse catch input contact points operate as general digital input if they are not designated as pulse catch input.
- 2) Pulse catch input contact points can be used 6 points from P000 to P005.

6.1.2 Input Filter function

External input of PLC option card selects Input Filter Time from the range of 0-1000ms of KGLWIN. Credibility secured system may be established by adjustment of input correction no. through using environment

1) Usage

Input signal status affects the credibility of system in where noise occurs frequently or pulse width of input signal affects as a crucial factor. In this case, the user sets up the proper input on/off delay time, then the trouble by miss operation of input signal may be prevented because the signal which is shorter than set up value is not adopted.

2) Operation

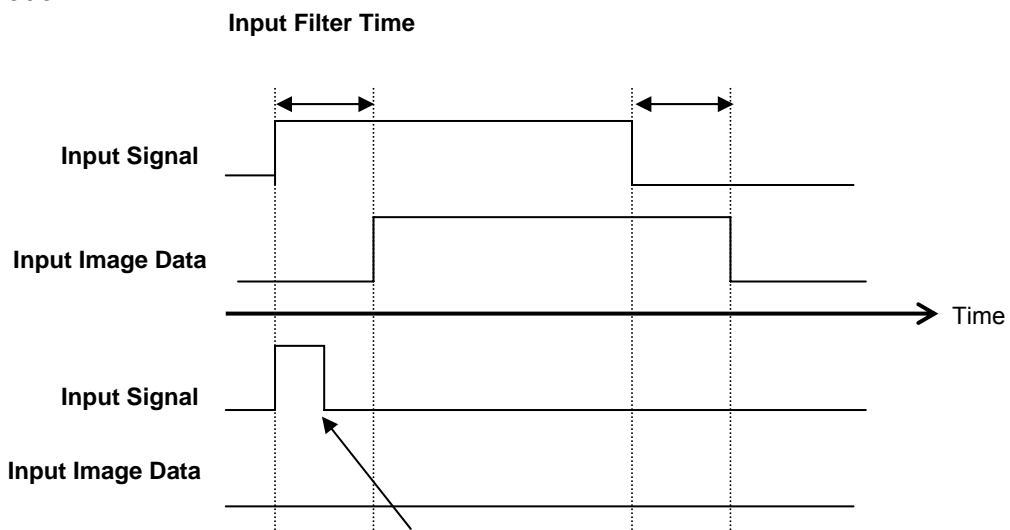

The narrower width pulse than input filter time is not considered as input signal

3) Using method

- (1) Click twice the basic parameter on the project window of KGLWIN.
- (2) The value of filter can be set up as one of 1ms unit to the Input Filter Time of the basic parameter window. (Input Filter Time is set up as default value of 10ms)
- (3) Set up Input Filter Time is conformed to all input.

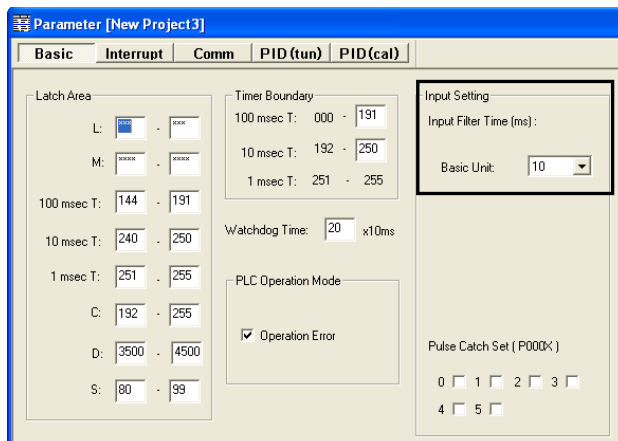

6.1.3 External Interrupt Function

PLC option card for iS7 inverter Series can perform 6 points of external contact interrupt by using input of main unit without special interrupt module.

1) Usage

This function is useful to execute a high speed execution regardless of scan time.

2) External Interrupt processing time

- P0 ~ P5 : 10 μ s

Remark

- Above Interrupt processing time not include the program processing time of external interrupt itself. It can be delayed by the processing time of interrupt program.

3) Operation Explanation

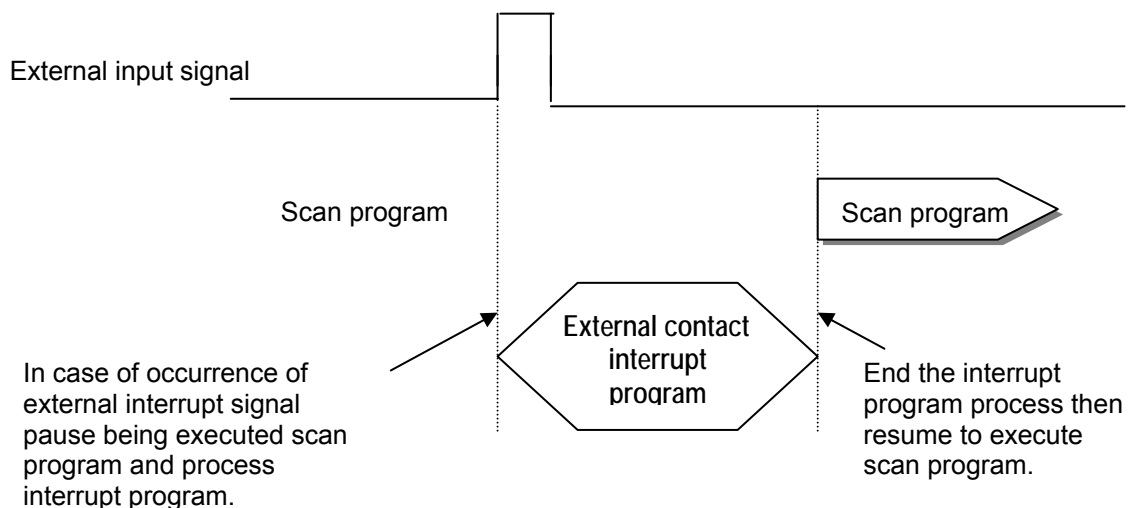

4) Function

- (1) Max. 6 points can be used to external interrupt input within P000 ~ P005.
- (2) The number of external interrupt can be set max. 6. Namely, the number of external interrupt is decreased by Time-driven Interrupt.
- (3) The execution conditions of external interrupt is divided into following 3 kinds.
 - Rising edge : Interrupt occurs at rising edge of external Interrupt contact point.
 - Falling edge : Interrupt occurs at falling edge of external Interrupt contact point.
 - Rising & falling edge : Interrupt occurs at both edges of external Interrupt contact point.

Chapter 6 Usage of Various Functions

5) Usage

- (1) Click twice the parameter on the project window of KGLWIN.
- (2) Designate contact point, no. of priority and movement condition of the task program which is moved by interrupt inputting.

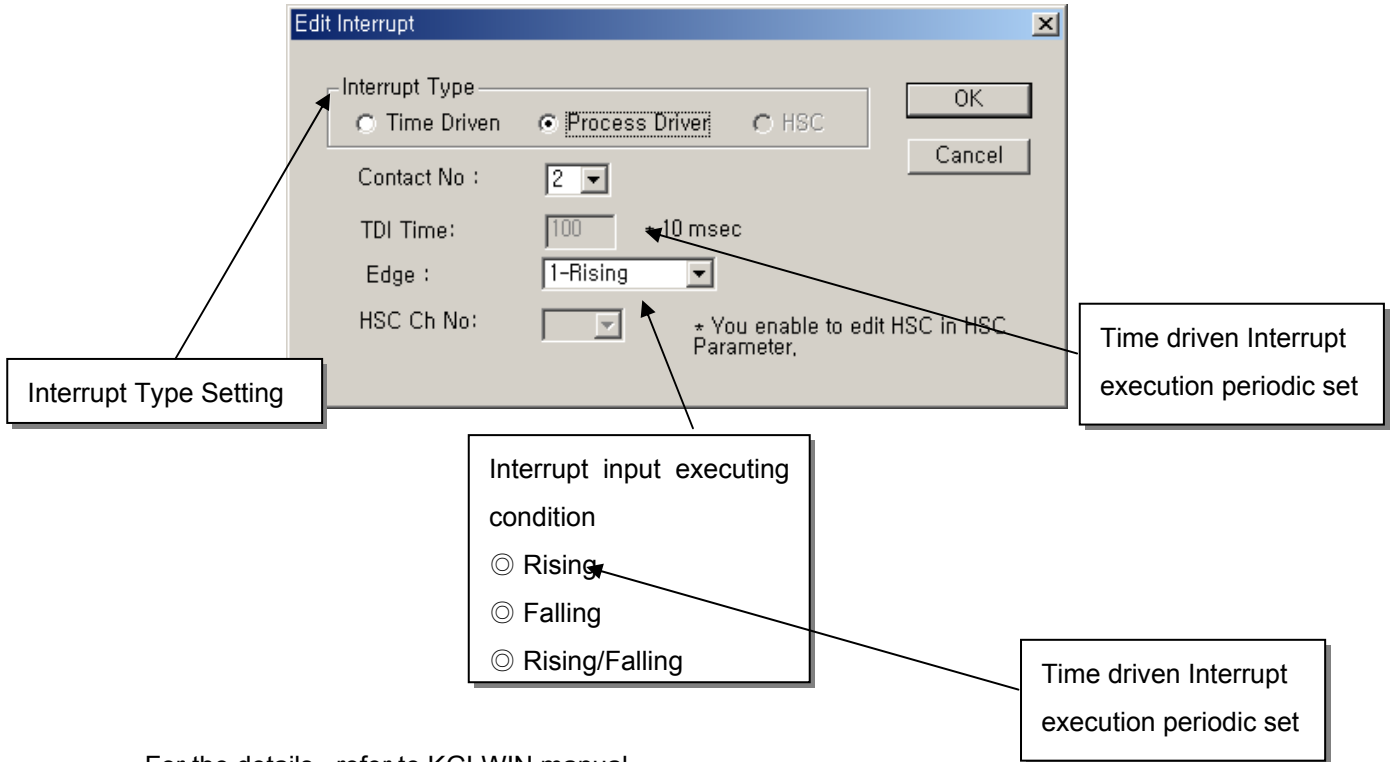

For the details , refer to KGLWIN manual.

6.1.4 PID Control Function

1) Introduction

This chapter will provide information about the built-in PID (Proportional Integral Derivative) function of PLC option card of iS7 inverter series. The PID control means a control action in order to keep the object at a set value (SV). It compares the SV with a sensor measured value (PV : Present Value) and when a difference between them (E : the deviation) is detected, the controller outputs the manipulate value (MV) to the actuator to eliminate the difference. The PID control consists of three control actions that are proportional (P), integral (I), and derivative (D).

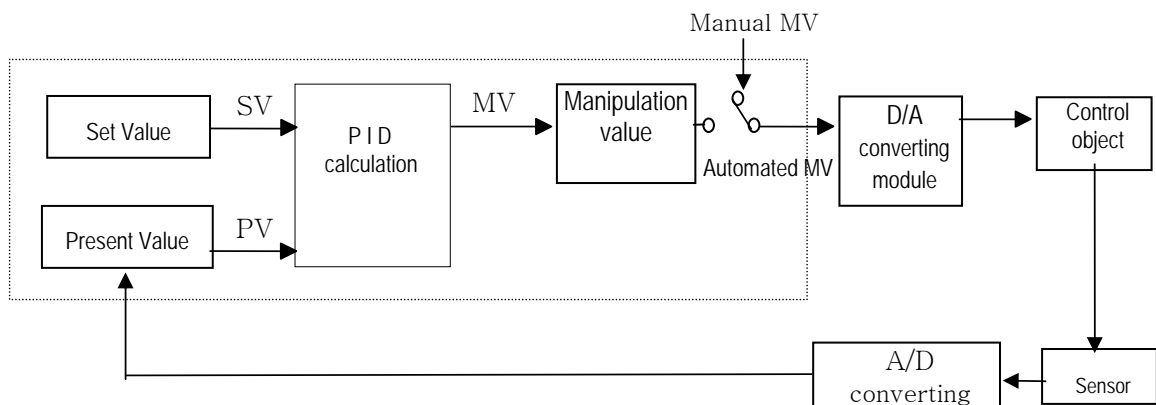

The characteristics of the PID function of PLC option card for iS7 inverter is as following;

- The PID function is integrated into the CPU module.
 - P operation, PI operation, PID operation and On/Off operation can be selected easily.
 - PWM(Pulse Width Modulation) output is available.
 - The manual output (the user-defined forced output) is available.
- By setting proper parameter, it can keep stable operation regardless of external disturbance.
- The operation scan time (the interval that PID controller gets a sampling data from actuator) is changeable for optimizing to the system characteristics.
- SV Ramp and Delta MV function are available.

Chapter 6 Usage of Various Functions

2) Specification

(a) Proportional Operation (P operation)

- ① P action means a control action that obtains a manipulate value which is proportional to the deviation (E : the difference between SV and PV)

$$MV = K_p \times E$$

- ② The deviation (E) is obtained by difference between SV and PV and the formula of deviation is as following;

$$MV = K_p \times [SV - PV]$$

where,

Kp: the proportional constant (gain),

SV: set value,

PV: present value

- ③ If the Kp is too large, the PV reaches to the SV swiftly, but it may cause a bad effect like oscillations.
- ④ If the Kp is too small, oscillation will not occur. However, the PV reaches the SV slowly and an offset may appear between PV and SV as shown in the Fig. 7.2.
- ⑤ The manipulation value (MV) varies from 0 to 4,000. User can define the maximum value of MV (MV_MAX) and minimum value (MV_MIN) within the range 0 ~ 4,000.
- ⑥ When an offset remains after the system is stabilized, the PV can be reached to the SV by adding a certain value. This value is called as bias value, and user can define the bias value.

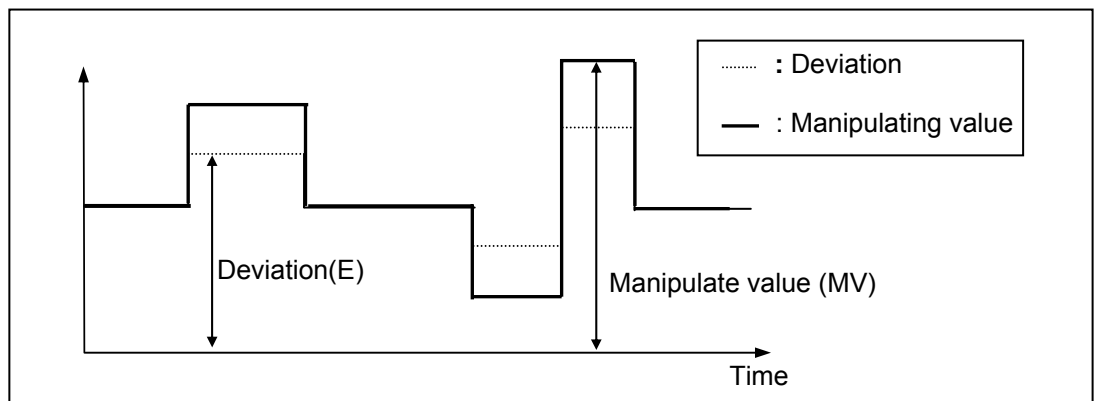

Fig 7.1 MV by P operation

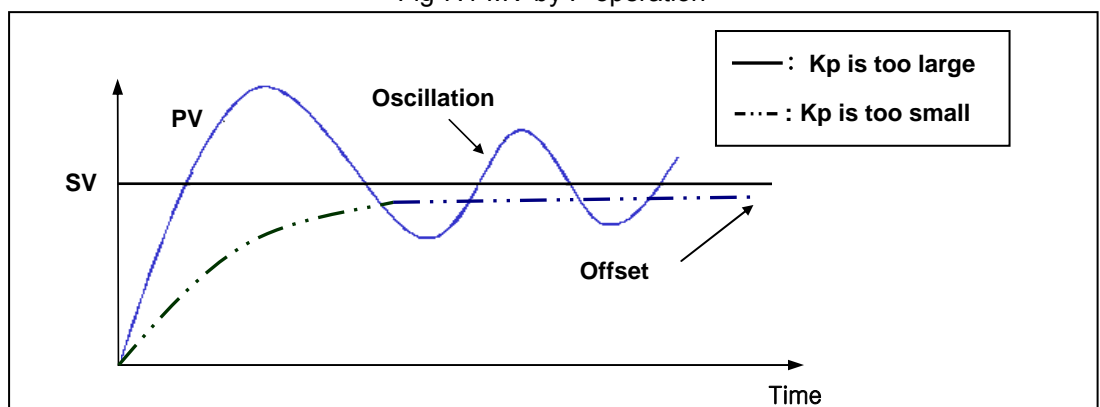

Fig. 7.2 The relation between Proportional constant (Kp) and present value (PV)

Chapter 6 Usage of Various Functions

(b) Integral Operation (I Operation)

- ① With integral operation, the manipulate value (MV) is increased or decreased continuously in accordance time in order to eliminate the deviation between the SV and PV. When the deviation is very small, the proportional operation can not produce a proper manipulate value and an offset remains between PV and SV. The integral operation can eliminate the offset value even the deviation is very small.

The period of the time from when the deviation has occurred in I action to when the MV of I action become that of P action is called Integration time and represented as T_i .

- ② Integral action when a constant deviation has occurred is shown as the following Fig. 7.3.

$$MV = \frac{K_p}{T_i} \int E dt$$

As shown in the expression, Integral action can be made stronger or weaker by adjusting integration time (T_i) in I action. That is, the more the integration time (the longer the integration time) as shown in Fig. 7.4, the less the quantity added to or subtracted from the MV and the longer the time needed for the PV to reach the SV.

As shown in Fig. 7.5, when the integration time given is short, the PV will approach the SV in short time since the quantity added or subtracted become increased. But, if the integration time is too short, then oscillations occur, therefore, the proper P and I value is requested.

- ③ Integral action is used in either PI action in which P action combines with I action or PID action in which P and D actions combine with I action.

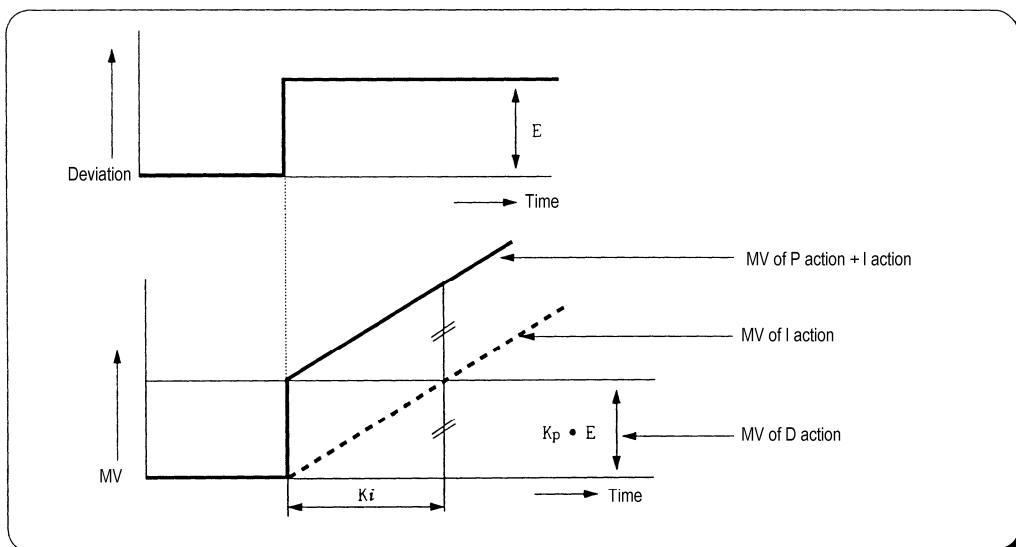

Fig. 7.3 The integral action with constant deviation

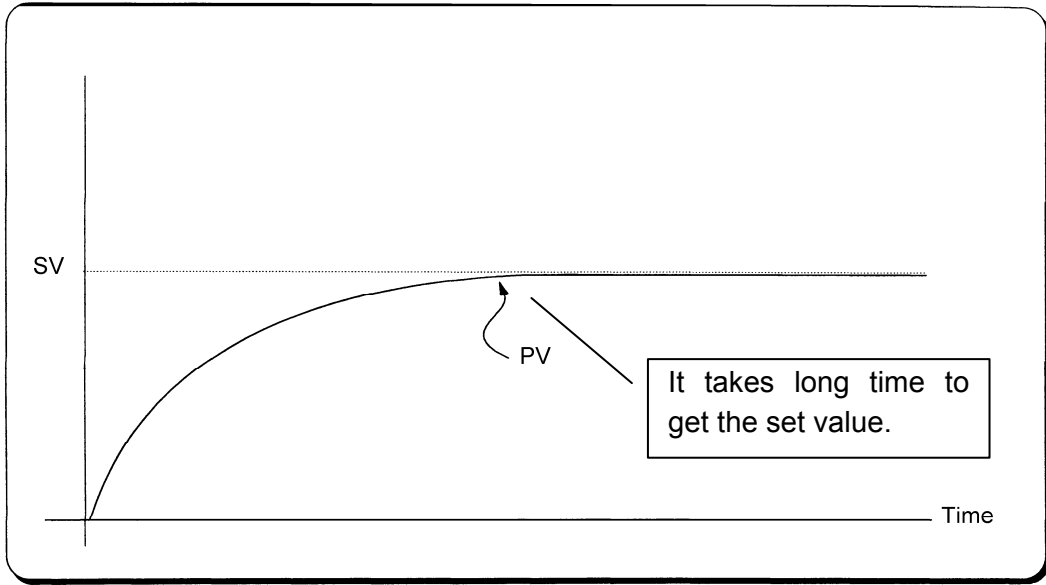

Fig. 7.4 The system response when a long integration time given

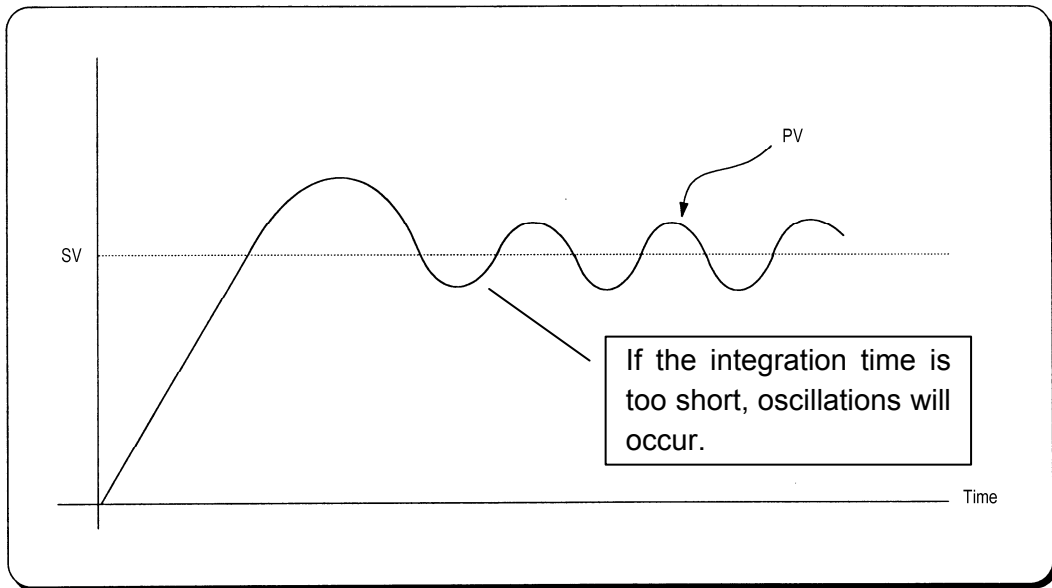

Fig. 7.5 The system response when a short integration time is given

Chapter 6 Usage of Various Functions

(c) Derivative operation (D action)

- ① When a deviation occurs, due to alteration of SV or external disturbances, D action restrains the changes of the deviation by producing MV which is proportioned with the change velocity (a velocity whose deviation changes at every constant interval) in order to eliminate the deviation.
- ② D action gives quick response to control action and has an effect to reduce swiftly the deviation by applying a large control action (in the direction that the deviation will be eliminated) at the earlier time that the deviation occurs.
- ③ D action can prevent the large changes of control object due to external conditions.
- ④ The period of time from when the deviation has occurred to when the MV of D action becomes the MV of P action is called derivative time and is represented as T_d .
- ⑤ The D action when a constant deviation occurred is shown as Fig. 7.6

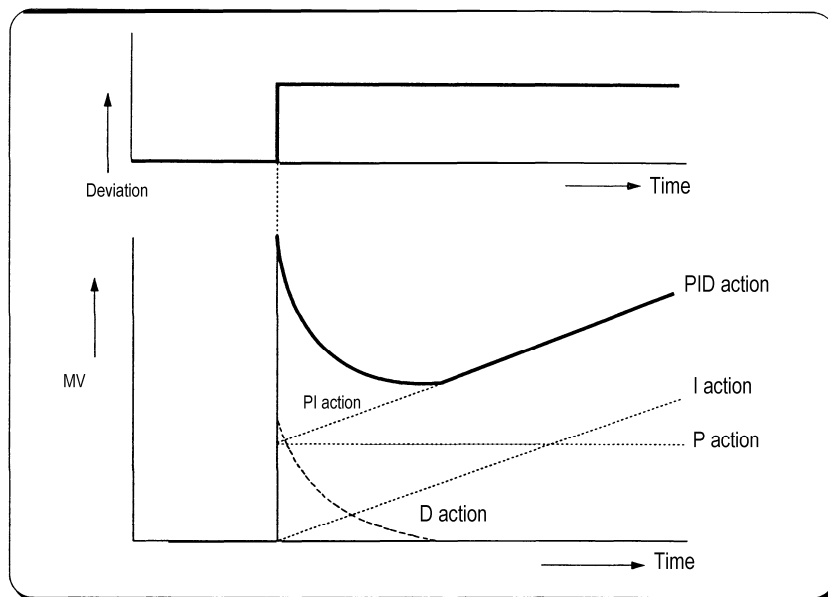

Fig. 7.6 Derivative action with a constant deviation

(d) PID action

- ① PID action controls the control object with the manipulation quantity produced by (P+I+D) action.
- ② PID action when a given deviation has occurred is shown as the following Fig. 7.7.

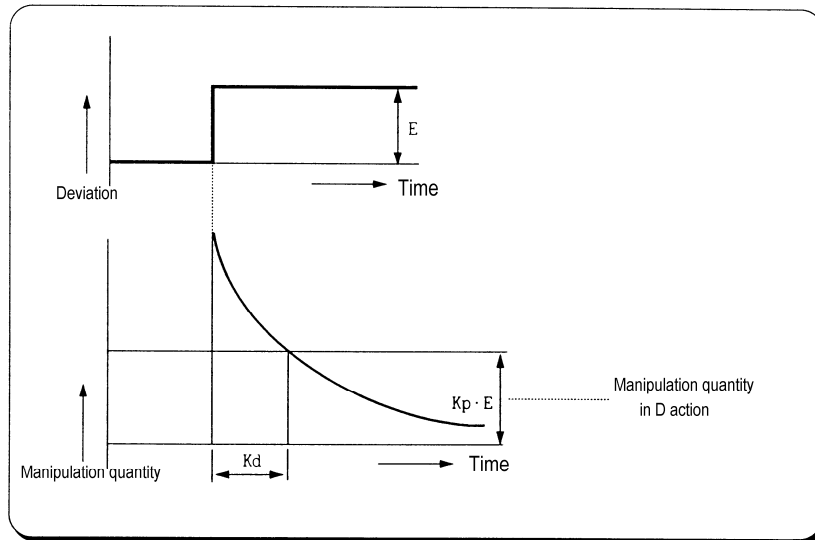

Fig. 7.7 PID action with a constant deviation

(e) Integral windup

All devices to be controlled, actuator, has limitation of operation. The motor has speed limit, the valve can not flow over the maximum value. When the control system has wide PV range, the PV can be over the maximum output value of actuator. At this time, the actuator keeps the maximum output regardless of the change of PV while the PV is over the maximum output value of actuator. It can shorten the lifetime of actuator.

When the I control action is used, the deviation term is integrated continuously. It makes the output of I control action very large, especially when the response characteristic of system is slow.

This situation that the output of actuator is saturated, is called as 'windup'. It takes a long time that the actuator returns to normal operating state after the windup was occurred.

The Fig. 7.8 shows the PV and MV of PI control system when the windup occurs. As shown as the Fig. 7.8, the actuator is saturated because of the large initial deviation. The integral term increase until the PV reaches to the SV (deviation = 0), and then start to decrease while the PV is larger than SV (deviation < 0). However, the MV keeps the saturated status until the integral term is small enough to cancel the windup of actuator. As the result of the windup, the actuator will output positive value for a while after the PV reached to the SV, and the system shows a large overshoot. A large initial deviation, load disturbance, or miss-operation of devices can cause windup of actuator.

There are several methods to avoid the windup of actuator. The most popular methods are adding another feedback system to actuator, using the model of actuator and stop integrating when actuator is saturated.

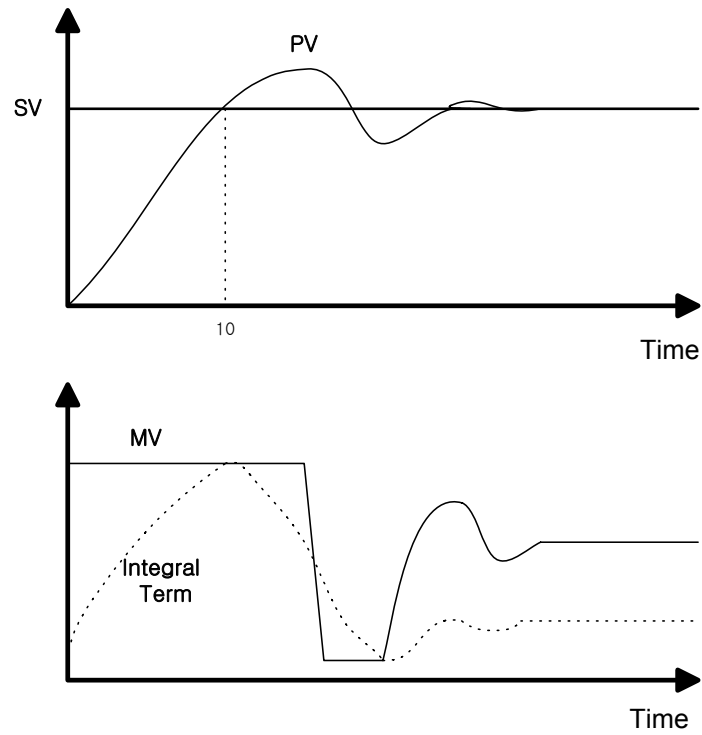

Fig. 7.8 Example of integral windup

Chapter 6 Usage of Various Functions

3) Realization of PID control on the PLC option card

In this chapter, it will describe how to get the digitized formula of the P, I, and D terms.

(a) P control

The digitized formula of P control is as following;

$$P(n) = K[SV(n) - PV(n)]$$

n : sampling number K : proportional gain constant

b : reference value SV : set value

PV : present value

(b) I control

The continuous formula of I control is as following;

$$I(t) = \frac{K}{T_i} \int_0^t e(s) ds \quad : \text{integral term}$$

K : proportional gain constant

T_i : integral time

e(s) : deviation value

By derivation about t, we can obtain;

$$\frac{dI}{dt} = \frac{K}{T_i} e \quad \text{where, } e = (SV - PV) : \text{deviation value}$$

The digitized formula is as following;

$$\frac{I(n+1) - I(n)}{h} = \frac{K}{T_i} e(n) \quad \text{where, } h : \text{sampling period}$$

$$I(n+1) = I(n) + \frac{Kh}{T_i} e(n)$$

(c) D control

The continuous formula of derivative term is as following;

$$\frac{Td}{N} \times \frac{d}{dt} D + D = -KTd \frac{dy}{dt}$$

N : high frequency noise depression ration

y : the object to be controlled (PV)

Chapter 6 Usage of Various Functions

4) Instruction and Parameter Setting

For the PID operation of PLC option card, following 2 instruction are included in the KGLWIN software.

No.	Name	Description
1	PID8	Perform the PID operation
2	PID8AT	Perform the auto tuning operation

(a) PID8 instruction parameter setting and explanation.

The screenshot shows the 'PID(Cal) Item Edit' dialog box with the following parameters and settings:

- Scan Time: 0 (1~100 or D Area)
- Operation Mode: 0 (0:Auto 1: Man or DArea)
- Man OP range: 0 (0~4000 or D Area)
- Output Limit Value:
 - Min: 0 (0~4000 or D Area)
 - Max: 0 (0~4000 or D Area)
- High Frequency Noise Removal Ratio: 0 (1~10 or D Area)
- Proportional Gain: 0 (1~10000 or D Area)
- Derivative time: 0 (0 ~ 20000 or D Area)
- Integral Time: 0 (0 ~ 20000 or D Area)
- D Area Range : D0 ~ D4999
- Mode Command Set:
 - Derivative
 - Integral
 - Propotional
 - PWM
- PWM set:
 - Period: 0 (10-100 or DArea)
 - Contact: 0 PArea (P40 - P57)
- SV Ramp : 1 (0~4000 or D영역)
- Δ MV : 4000 (0~4000 or D영역)
- BIAS Value: 0 (0~4000 or D Area)
- PV(Current): 0 (D Area)
- SV(Target): 0 (0~4000 or D Area)
- PID Algorithm:
 - verocity
 - positioning

(1) Scan Time

Scan time is the period of reading data (sampling), and also 10 times scaled up. The range of sampling time is 0.1 ~ 10 seconds, and actual input range is 0 ~ 100. Generally, scan time of Digital PID control should be less than 1/10 of time constant of system response for better performance. Time constant is the time taken the system's step response reaches to the 63% of steady state.

(2) Operation Mode

Select automatic or manual operating mode. (Setting range: 0, 1 or D area)

(3) Manual Operate range

When manual operation is designates , manual operation value designates. (input range : 0 ~ 4000)

(4) Output Limit Value

Designates minimum and maximum values of available manipulate value. (range : 0 ~ 4000)

Chapter 6 Usage of Various Functions

(5) High Frequency Noise Depression Ratio

High frequency noise removal ratio is used for derivative control operation, and shows the ratio of high frequency noise depression. If there is a lot of high frequency noise in the control system, select the value as higher value.

Otherwise, leave the 1. The range of parameter is 0 ~ 10 and it is not scaled up, so input the designated value directly. (it is possible that parameter value designates 'D' area also)

(6) Proportional gain

It is the ratio of proportional operation. Proportional gain is the 100 times scaled up value. (Setting range: 1~10000)

(7) Derivative time and integral time

I_TIME and D_TIME are 10 times scaled up. For example, input 18894 if the designated I_TIME value is 1889.4. The range of actual input is 0 ~ 20000. (it is possible that parameter value designates 'D' area also)

(8) Mode command set (P, I, D control)

Following 7 operation modes are available.

No.	EN_P	EN_I	EN_D	PWM output	Operation
1	1(Enable)	0(Disable)	0(Disable)	0(Disable)	P operation
2	1(Enable)	1(Enable)	0(Disable)	0(Disable)	PI operation
3	1(Enable)	1(Enable)	1(Enable)	0(Disable)	PID operation
4	1(Enable)	0(Disable)	0(Disable)	1(Enable)	P operation/PWM output
5	1(Enable)	1(Enable)	0(Disable)	1(Enable)	PI operation/PWM output
6	1(Enable)	1(Enable)	1(Enable)	1(Enable)	PID operation/PWM output
7	0(Disable)	0(Disable)	0(Disable)	0(Disable)	On/Off operation

- Other operation modes, such as PD or I, are not permitted..
- If PWM output is selected, Manipulated value is outputted PWM output to designated output.

(9) PWM set

PWM(Pulse Width Modulation) is a output method which changes on-off duty of output pulses by calculated manipulation value. Fig 7.9 shows example of PWM output. Using PWM output, PID control system can be constructed easily without D/A conversion module and power regulator.

When PWM is designates , 'scan time' item is disabled and 'PWM' items can be designated. In this case, scan time is set to designated PWM output period. The range of PWM output period is 1 ~ 10 seconds, and actual input range is 10 ~ 100. PWM output point is only available for output contact of main unit.

Chapter 6 Usage of Various Functions

(10) Bias

The Bias data is used for the compensation of offset in the proportional control. The range of input is 0 ~ 4000 or D area.

Be cautious that The actual range of Bias is -2000 ~ 2000. namely, 0~2000 represents 0 ~ +2000 and 2001 ~ 4000 represents -1 ~ -2000.

Example> If offset(SV-PV) is 100 → Bias should be 100.
If offset(SV-PV) is -100 → Bias should be 2100.

(11) SV (Setting Value), PV(Present Value)

SV (setting value : the designated value) and PV (process value : present value) of PID operation have the range 0 ~ 4000. The range can be set with the value of data register. (Present value only can be set by data register.) Setting value means the designated value to control and present value means the current value of controlled device from sensor.

(12) PID algorithm

In PLC option card for iS7 inverter, two types of PID algorithm are available. The velocity form(Speed) and positioning form.

Velocity form(Speed) operates incremental manners. Namely, it calculates the change(Δn) required from previous manipulate value(MV $n-1$), but positioning form calculates an absolute manipulate value(MV n) every sampling steps. Generally, The velocity form is suited for the system in which load change is slow like temperature control system, and positioning form is useful for system which's load change is fast.

(b) PID8AT instruction parameter setting and explanation.

Scan Time : (1 ~ 100) or (D0 ~ D4999)

Current value : (D0 ~ D4999)

Target value : (0 ~ 4000) or (D0 ~ D4999)

Identification Method :

Relay Method PRC Method

OK Cancel

(1) Scan time

S_TIME is the period of reading data (sampling), and 10 times scaled up for more precious operation. The range of sampling time is 0.1 ~ 10 seconds, and actual input range is 0 ~ 100.

Chapter 6 Usage of Various Functions

(2) Setting Value, Process Value

SV (set value : the designated value) and PV (process value : present value) of PID operation have the range integer 0 ~ 4000. The range is set with the consideration of the resolution of A/D and D/A module of PLC option card (12 bits) and offset value. When setting the SV or PV, please be careful when converting the analog value of control object (temperature, velocity, etc.) to digital value that are the output of A/D convert module.

(3) Tuning method

The PLC option card for iS7 inverter perform auto-tuning operation in two methods. One is relay response method and the other is process reaction curve method.

1) Relay response method

- PID parameters are obtained by On/Off operation during 1 cycle of PV variation.
- PID parameters are obtained by amplitude and period of oscillation
- The On/Off operation will occur at the SV value.

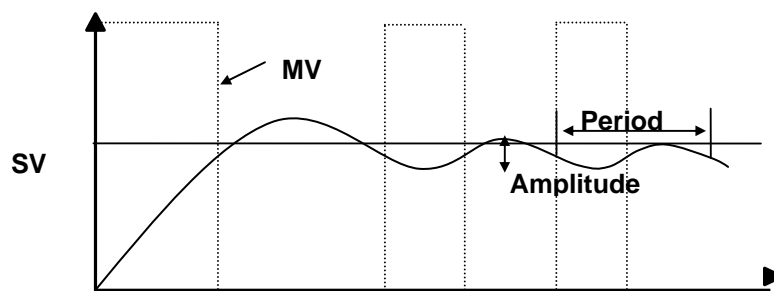

2) Process reaction curve method (PRC method).

- PID parameters are obtained by step response of process.
- It is useful for time 1st order time delay system expressed as following

$$K \frac{e^{-Ls}}{Ts + 1}$$

- Obtained parameters may not accurate if the process can't approximated to 1st order system, In this case, use relay response method.

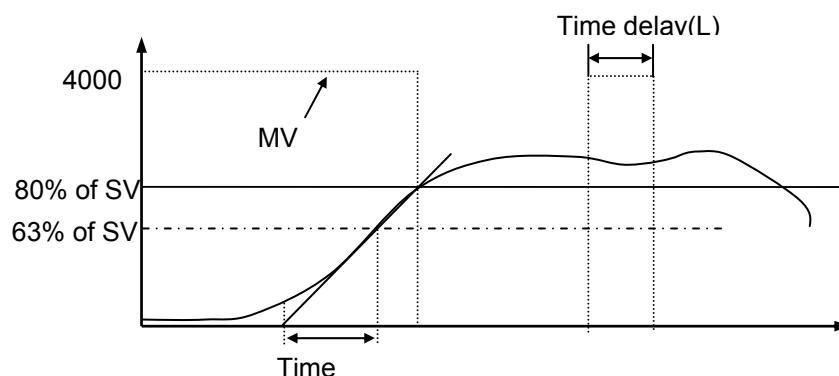

Chapter 6 Usage of Various Functions

5) Instruction

(1) PID8

Instruction		Available device										No. of Steps	Flag					
		M	P	K	L	F	T	C	S	D	#D		integer	Error (F110)	Zero (F111)	Carry (F112)		
PID8	n											O		O	5	O		
	S1											O						

Flag Set

Error (F110)	Error flag turns on when designating area is over and the instruction isn't executed.
--------------	---

Designation

n	Registration No. at parameter(0-7)
S1	Execution status registration area

■ PID8 (PID operation)

a) Usage

- When the condition of execution is on, PID operation executes.
- 'n' is registration No.at parameter(0 ~ 7)

b) Example Program



- When the input condition M0 turns on, PID operation executes at no.2 parameter.
- PID execution status registrates D0000 and the output value of control result registrates D0001.
- If SV Ramp is designated, current SV is registrate D0005

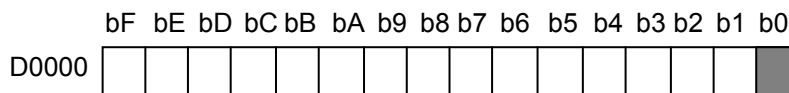

↓
Done : normal execution signal

Chapter 6 Usage of Various Functions

(2) PID8AT

Instruction		Available device										No. of Steps	Flag					
		M	P	K	L	F	T	C	S	D	#D		integer	Error (F110)	Zero (F111)	Carry (F112)		
PID8AT	n											O		O	5	O		
	S1											O						

Flag Set

Error (F110)	Error flag turns on when designating area is over and the instruction isn't executed.
--------------	---

Designation

n	Registration No. at parameter(0-7)
S1	Execution status registration area

■ PID8AT (Auto-tuning by parameter)

a) Usage

- When the condition of execution is on, PID auto tuning operation executes and calculates P,I,D constant.
- 'n' is registration No.at parameter(0 ~ 7)
- S1 is execution status and P,I,D constant registration area.

b) Example program



- When the input condition M0 turns on, PID operation executes at no.2 parameter.
- PID execution status stores D0000 and the output value of control result stores D0001 and P,I,D constant sequentially store D002(P),D003(I),D004(D).

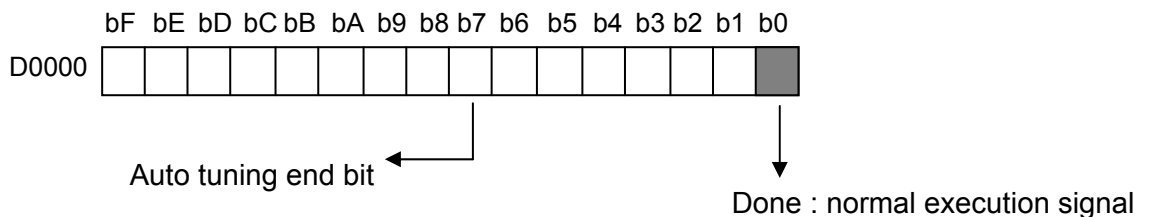

6) Example Program

(1) System Configuration

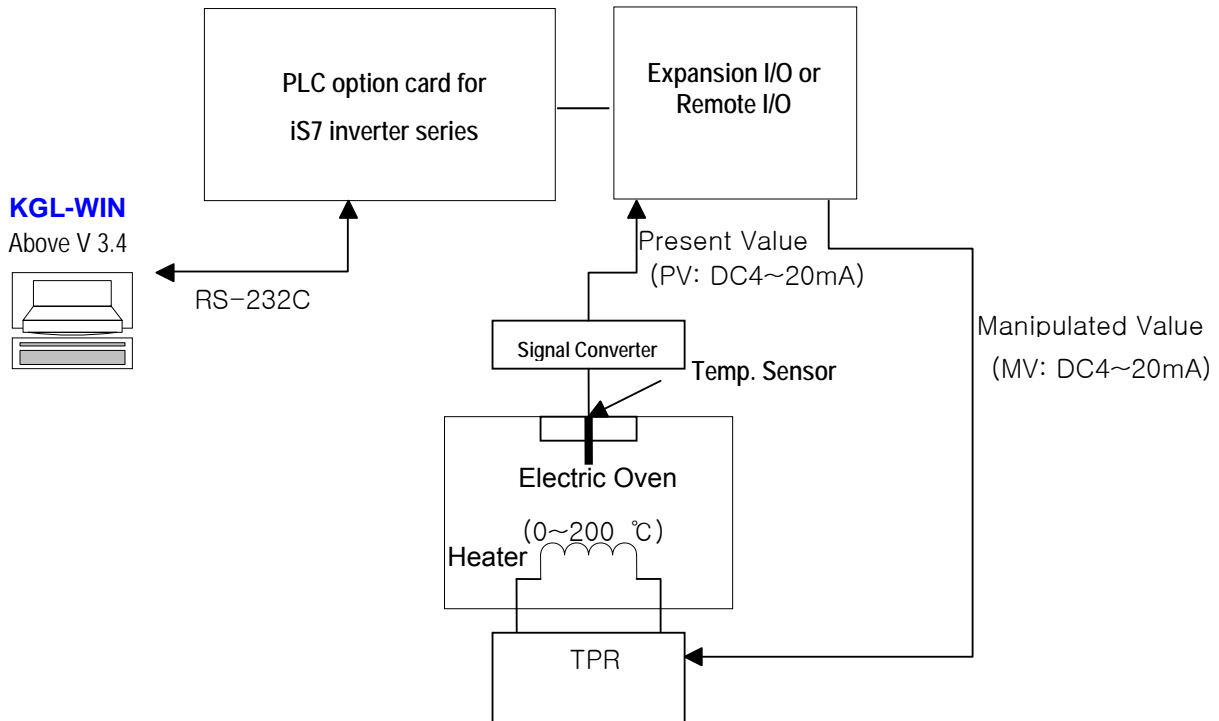

(2) Initial Setting

a) PID Control function (parameter setting by built-in function of PLC option card)

- Operation Scan Time: set by 1 second (Setting value = 10)
- Operation mode: Automatic setting
- Output Limit Value: Max. = 4000, Min. = 0
- Manipulated Value setting: Set by 0 (Automatic operation mode)
- High Frequency Noise Removal setting: set by 10
- Setting Value (when Resistor Thermal Detector sensor is used)
960(60 °C), 1120(70 °C), 1280(80 °C), 1600(100 °C)
- Current value setting: D4980

(Temporary D area to save the current temperature measured by temperature sensor)

- BIAS setting: 0 (If only P control is used, input proper value other 0)
- P,I,D Algorithm setting: Select proper algorithm.
(If PWM output is needed, select related item)
- PWM period, Contact Setting: In case of PWM output is set, input the proper period and output relay value.

b) Auto-tuning Control function

(parameter setting by built-in function of PLC option card)

- Setting Value (when Resistor Thermal Detector sensor is used)

960(60 °C), 1120(70 °C), 1280(80 °C), 1600(100 °C)

- Operation Scan Time: Set by 1 second (Setting value = 10)

- Present Value setting: D4980

(Temporary D area to save the current temperature measured by temperature sensor)

- Tuning method: Relay response method

c) Remote I/O (A/D Converter)

- Input range: DC 4~20 mA

- Data saving area of converted value of A/D: D4980

d) Remote I/O (D/A Converter)

- Output range: DC 4~20 mA

- Data saving area of converted value of D/A: D4982

(3) Program Explanation

a) PID operation explanation (without Auto-tuning function)

- Measure current temperature (-200~600°C) by RTD module then digital conversion value(0 ~ 4000) is stored to D4980
- PID8 instruction will calculate manipulate value (MV : 0 ~ 4000) based on PID parameter settings (P_GAIN, I_TIME, D_TIME, etc.) and PV from RTD module. Then, the calculated MV is output to the channel 0 of D/A module. (PID operation Done bit: bit0)
- D/A module will convert the MV to analog signal and output to the actuator (power converter).

b)PID operation explanation (with A/T function)

- Measure current temperature (-200~600°C) by RTD module then digital conversion value(0 ~ 4000) is stored to D4980
- PID8AT instruction will calculate manipulate value (MV : 0 ~ 4000) based on the SV and PV from RTD module. Simultaneously, the PID8AT instruction will calculate P,I and D parameters.
- The END bit of auto tuning status device will be 1 when the auto tuning is completed. Then, PLC option card will start PID operation with PID parameters that are calculated by Auto-tuning function.

Chapter 6 Usage of Various Functions

(4) Parameter Setting and Program

a) In case of using PID function only

Scan Time: 0 (1~100 or D Area)
Operation Mode: 0 (0:Auto 1: Man or DArea)
Man OP range: 0 (0~4000 or D Area)
Output Limit Value
 Min : 0 (0~4000 or D Area)
 Max : 0 (0~4000 or D Area)
High Frequency Noise Removal Ratio: 0 (1~10 or D Area)
Proportional Gain: 0 (1~10000 or D Area)
Derivative time : 0 (0 ~ 20000 or D Area)
Integral Time: 0 (0 ~ 20000 or D Area)
 D Area Range : D0 ~ D4999

Mode Command Set
 Derivative Integral
 Proportional PWM

PWM set
Period 0 (10~100 or DArea)
Contact 0 PArea (P40 - P57)

SV Ramp : 1 (0~4000 or [Area])
Δ MV : 4000 (0~4000 or [Area])
BIAS Value: 0 (0~4000 or D Area)
PV(Current): 0 (D Area)
SV(Target): 0 (0~4000 or D Area)

PID Algorithm
 velocity positioning

OK Cancel

When PWM set is selected, Scan time parameter is disabled and this value is ignored.

When PWM is designated, this window is activated and PID function operates by PWM period.

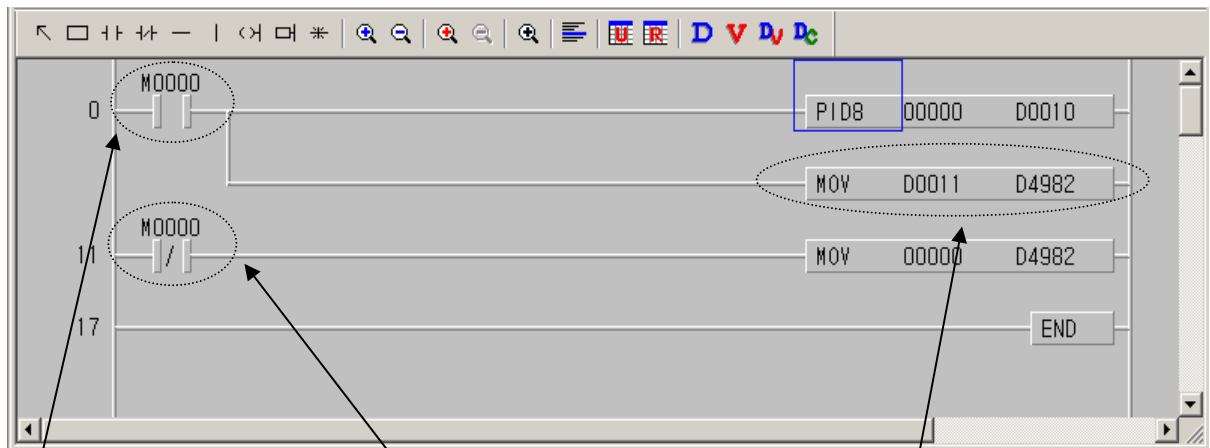

When M0 turns on, PID operation executes at no.0 parameter.

When M0 turns off, CPU stop PID operation and output 0 to D/A module.

The manipulated value is out to D/A module.

Chapter 6 Usage of Various Functions

b) In case of using combined function of PID operation and Auto tuning.

This program shows the PID operation with the Auto-tuning value of P, I, and D. After Auto-tuning is completed, PID operation will start with calculated PID parameter

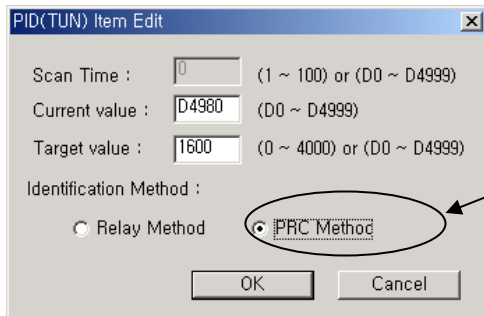

When RPC Method is selected, the scan time fixed to 1 sec.

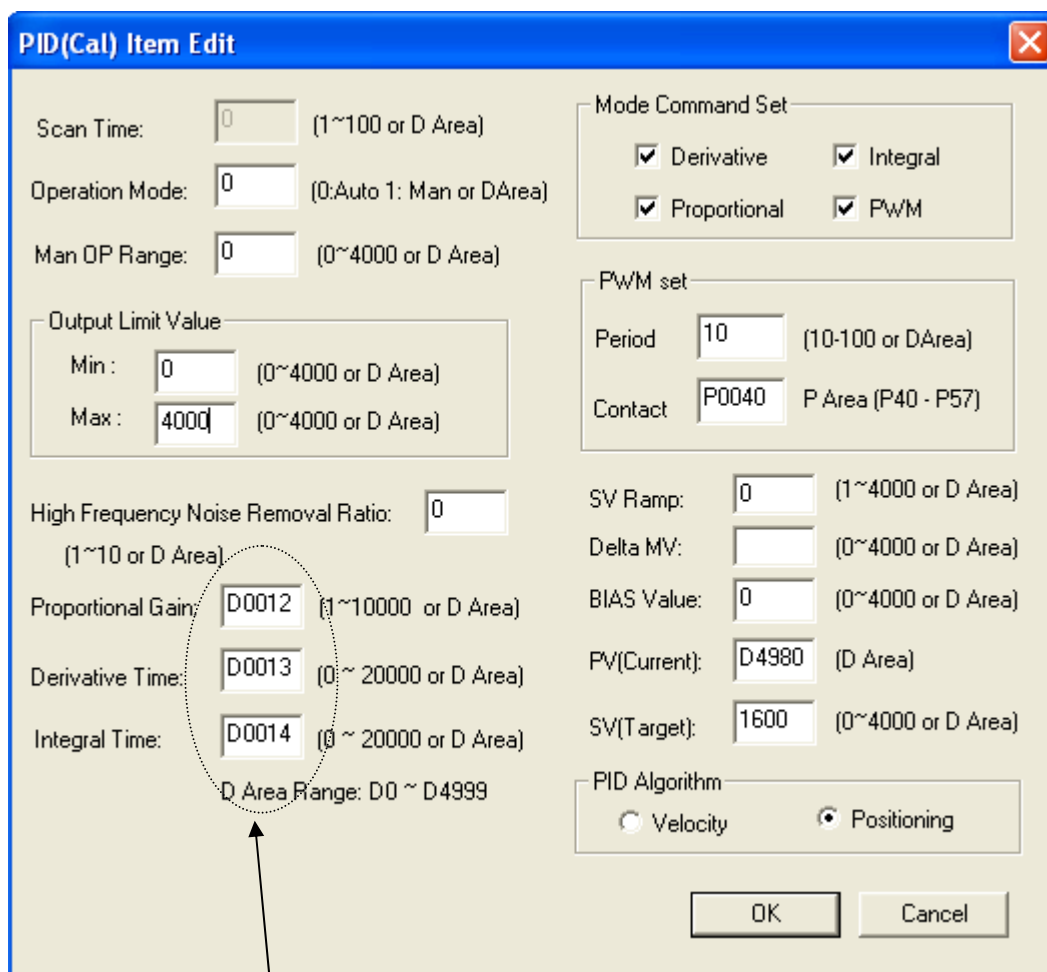

As a result of PID8AT execution, Proportional gain(P), Derivative time(D), Integral time(I) are stored D0102, D0103, D0104.

Chapter 6 Usage of Various Functions

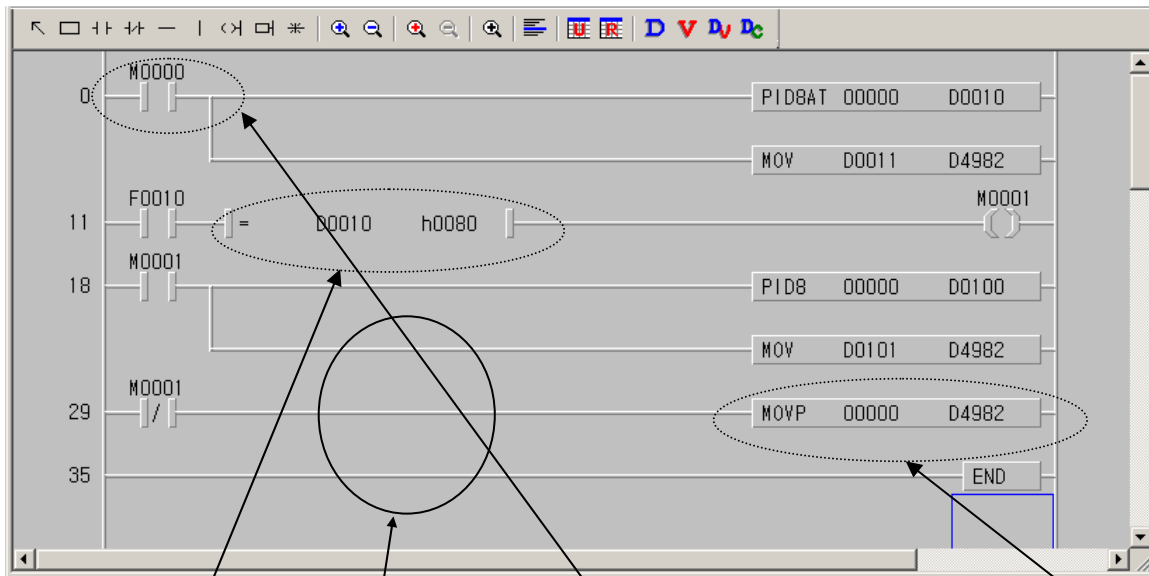

When auto tuning ends at D0010, M0001 turns on and PID control starts.

When M0000 turns on, auto tuning starts. Calculated P,I,D parameters are saved to D0012, D0013, D0014.

When M0001 turns off, output 0 to D4982.

Chapter 7 Exclusive Functions for iS7 Inverter Control/Monitoring

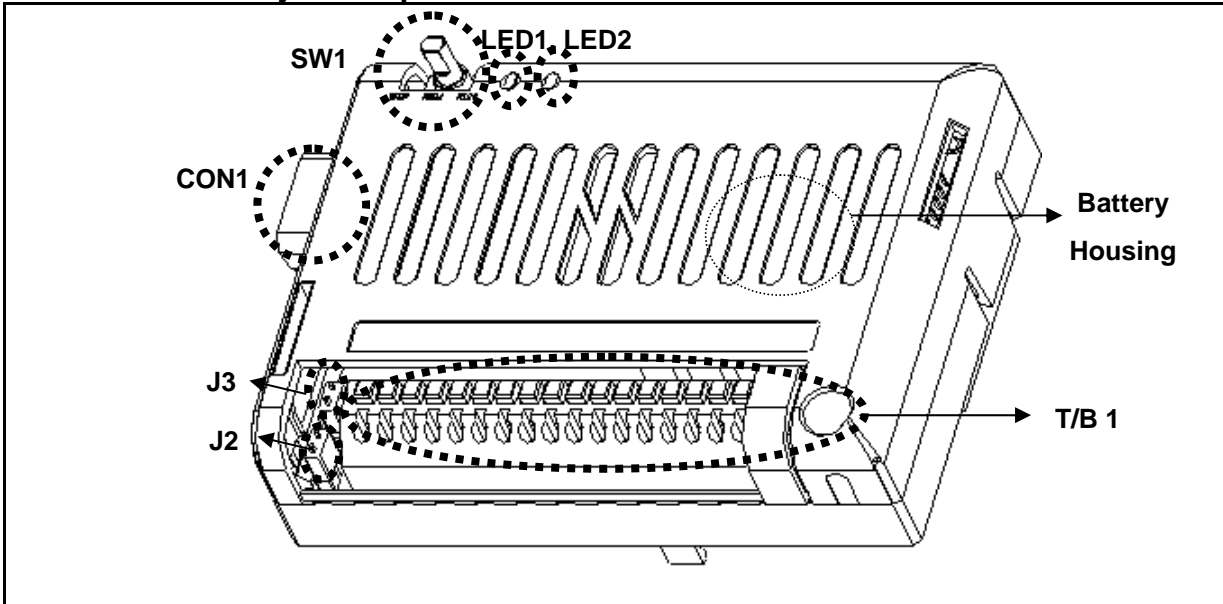

7.1 Outline and Installation

7.1.1 Outline and Major Components of the Product

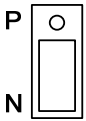

Symbol	Name	Description
LED1	RUN LED	ON state: local run (SW1 is at RUN position) or remote run (SW1 is at PAU/REM position, and RUN icon is selected in KGLWIN)
LED2	ERR LED	1) Blink: flickers in error condition. 2) OFF: in normal condition for operation.
SW1	Mode Selection Switch	1) RUN position: program running 2) PAU/REM position: pause, executing remote run/stop, etc. 3) STOP position: program stopped
J1	PLC OS Download Jumper	1) The default jumper at product delivery. Only manufacturer's A/S personnel are allowed to change the default setting. Keep the setting as shown below. <div style="display: flex; align-items: center;"> <div style="margin-right: 10px;">BM</div> <div style="border: 1px solid black; border-radius: 50%; width: 10px; height: 10px; margin-right: 5px;"></div> <div style="margin-right: 10px;">5G</div> <div style="border: 1px solid black; width: 10px; height: 10px; margin-right: 5px;"></div> <div style="margin-right: 10px;">NON</div> <div style="border: 1px solid black; width: 10px; height: 10px; margin-right: 5px;"></div> <div style="margin-left: 10px;"> <p>Normal Mode</p> </div> </div>
J2	Terminal Selection Jumper	1) ON: select RS485 communication terminal resistance (internal 120ohm resistor). 2) OFF: do not select RS485 communication terminal resistance.

Chapter 7 Exclusive Functions for iS7 Inverter Control/Monitoring

Symbol	Name	Description	
J3	NPN/PNP Selection Jumper	<p>1) NPN mode: connects terminal block input (P00~P05) and 24G. for details, see page 7-5.</p>  <p>Terminal input acts as NPN.</p> <p>2) PNP mode: connects terminal block input (P00~P05) and 24P. for details, see page 7-5.</p>  <p>Terminal input acts as PNP.</p>	
CON1	RS232C Communication Connector	Connector for connection with KGLWIN	
Battery	Battery Housing	<p>1) Function: in case of power failure, maintain the data of the latch area of PLC option and RTC time data.</p> <p>2) Battery type: coin-type lithium ion battery (CR2032)</p> <p>3) Service life: approx. 4 years in power-off state (at room temperature, battery capacity 220mAh)</p>	
TB1	External Terminal Block	1: S+(RS485)	2: S-(RS485)
		3: 24G	4: Terminal input P00
		5: Terminal input P01	6: Terminal input P02
		7: Terminal input P03	8: Terminal input P04
		9: Terminal input P05	10: 24G
		11: 24P (external 24V output)	-
		12: Terminal output P40	13: Terminal output P40C
		14: Terminal output P41	15: Terminal output P41C
		16: Terminal output P42	17: Terminal output P42C
18: Terminal output P43	19: Terminal output P43C		

Detail outline of the external terminal block (TB1) is shown below.

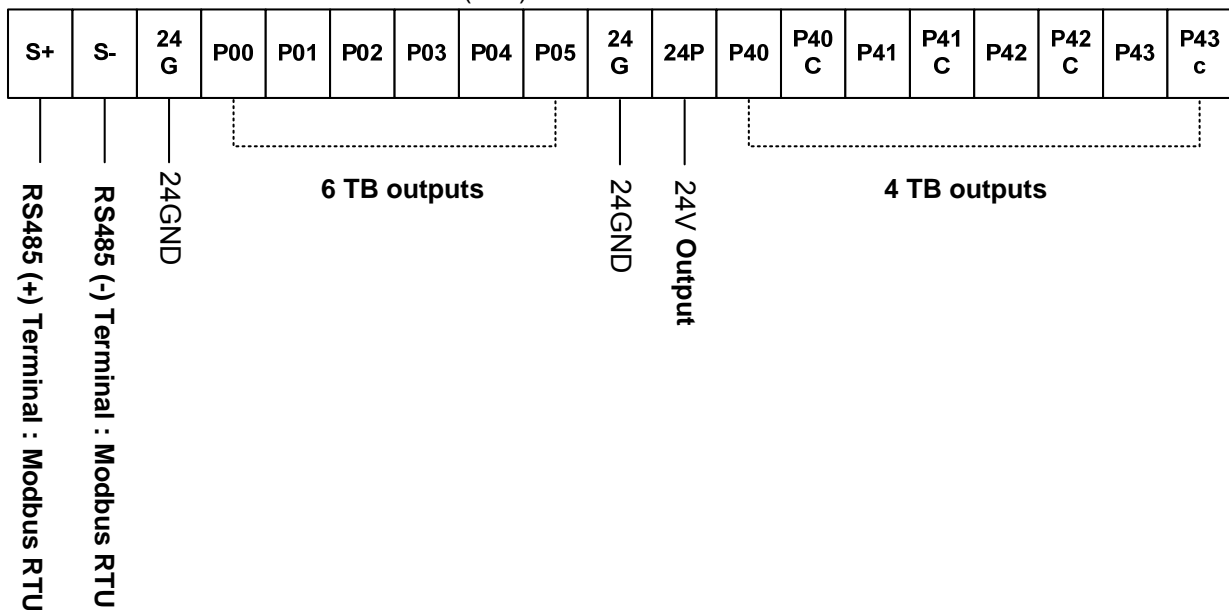



Chapter 7 Exclusive Functions for iS7 Inverter Control/Monitoring

7.1.2 Detail description of the components

(1) Mode Selection Switch (SW1 in the outline drawing)

The SW1 shown in the product outline drawing is for mode selection.

PLC Option Operation Status		Settings of the Mode Selection Switch and KGLWIN
Run	Local Run	1. Mode selection switch: RUN position
	Remote Run	1. Mode selection switch: set to AU/REM position. 2. Select the icon shown below (in the circle). 
Stop	Local Stop	1. Mode selection switch: STOP position
	Remote Stop	1. Mode selection switch: set to PAU/REM position. 2. Select the icon shown below (in the circle). 
Pause	Local	1. Mode selection switch: move to PAU/REM position during Local run.
	Remote	1. Mode selection switch: set to PAU/REM position. 2. Select the icon shown below (in the circle). 

(2) Display LED (LED1, LED2 in the outline drawing)

LED1(RUN LED) and LED2(ERR LED) are designated in the outline drawing.

Classification	RUN LED	ERR LED	Remark
STOP Status	OFF	OFF	
RUN Status	ON	OFF	RUN LED remains ON, not blinking
Heavy Error	-	ON(100ms)/OFF(100ms), blinking	See 10.5 Error Code List.
Light Error	-	ON(500ms)/OFF(500ms), blinking	See 10.5 Error Code List.
Program Error	-	ON(1000ms)/OFF(1000ms), blinking	See 10.5 Error Code List.
Error in communication with the inverter ^(Note 1)	ON(500ms)/OFF(500ms), blinking	ON(500ms)/OFF(500ms), blinking	RUN LED and ERR LED blink at the same intervals (500ms).

^(Note 1) the inverter and PLC option card maintain data communication. This error occurs if the inverter fails to response to the PLC option card within specified time (approx. 300ms), due to an external cause such as noise.

(3) Serial (RS232C) Communication (CON1 in the outline drawing)

This part is designated with CON1 in the outline drawing.

In the RS232C used in this PLC option, No. 2 and No.3 lines are cross-linked as shown below, while No. 5 is interconnected.

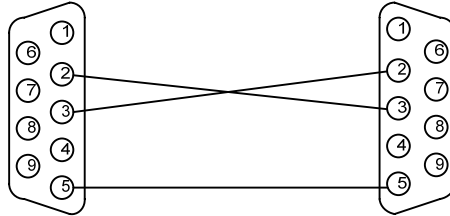

1) For KGLWIN download

User can download the ladder program made out in the KGLWIN.

The related jumper is J1, which must be set up as shown below (default set position)

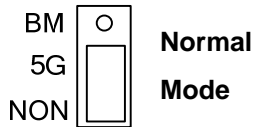

2) For CPU OS download (please contact A/S center if you have to change the setting)

This function is not available for users. Contact our A/S center.

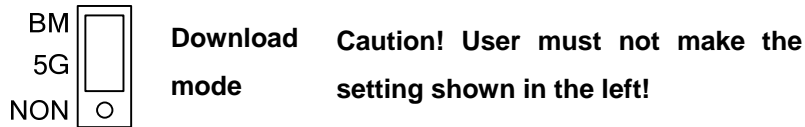

(4) RS485 (Modbus-RTU Protocol: Master) Communication (S+ and S- terminals of the TB1 in the outline drawing)

In the product outline drawing, the S+ (RS485 + terminal) and S-terminal (RS485 –terminal) of the TB1 (external terminal block).

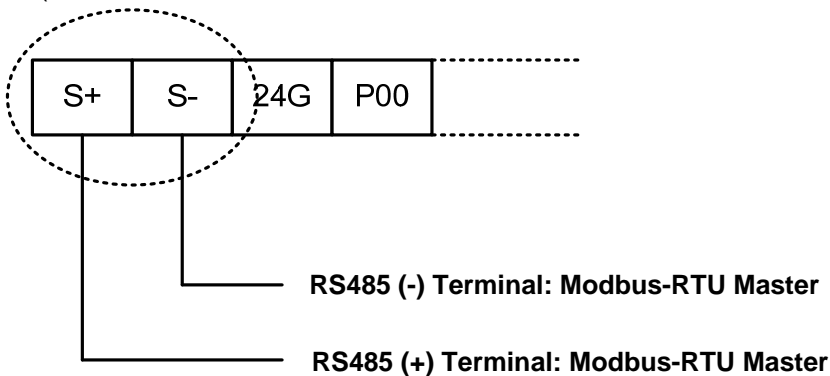

The standard Modbus-RTU protocol is supported in this product, and it is the master protocol. The Remote I/O, inverter, etc., built-in with Modbus-RTU (Slave) can be configured as the lower level.

Chapter 7 Exclusive Functions for iS7 Inverter Control/Monitoring

(5) Terminal input (P00~P05 terminals of TB1 in the drawing)

Total 6 terminal inputs are supported from P00~P05 on the external terminal block (TB1).

◆ NPN (Sink) mode

1) Set the J3 (NPN/PNP selection jumper) as shown below.

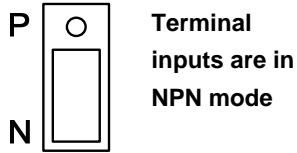

2) Connect the wires to the external terminal block (TB1). The figure below shows PO connection only for convenience (same for P1~P5 terminals).

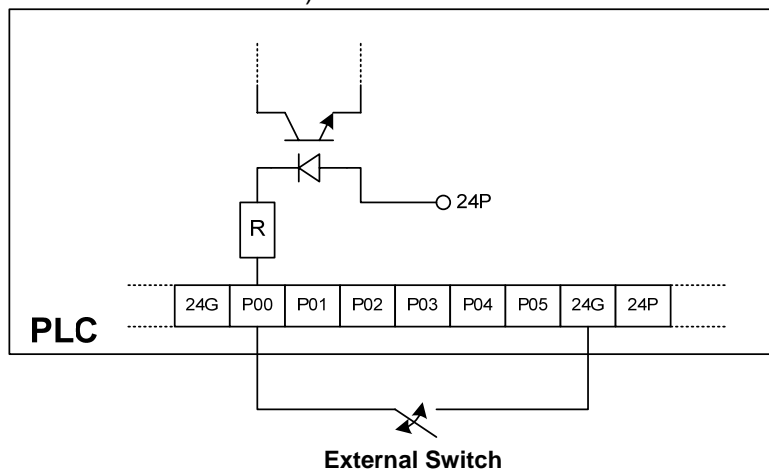

◆ PNP (Source) Mode

1) Set up the J3 (NPN/PNP selection jumper) as shown below.

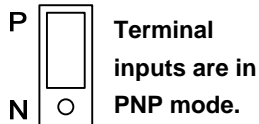

2) Connect the wires to TB1 as shown below. As illustrated, this product provides a 24V output from the terminal block. In the figure below, the 24V output is used for PO connection (same for the P1~P5 terminals).

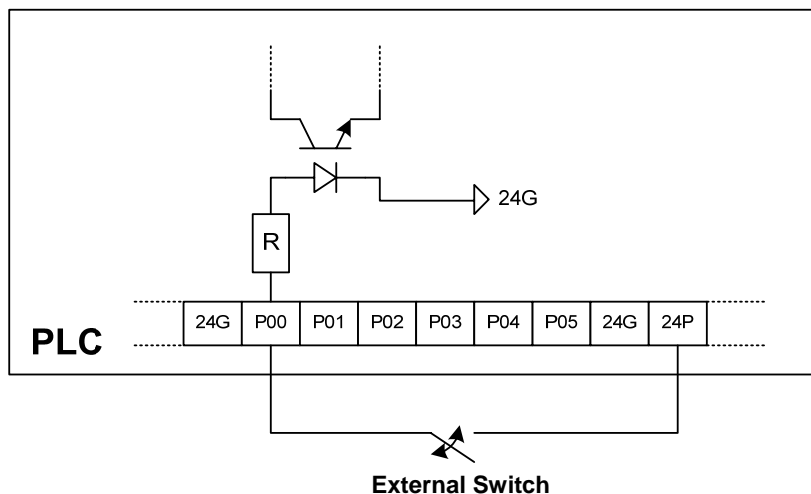

(6) Terminal output (P40~P43 terminals of TB1 in the outline drawing)

This product provides total 4 terminal output contacts (4 relay contacts) which are P40~P43 on the TB1. Connection method is as shown below.

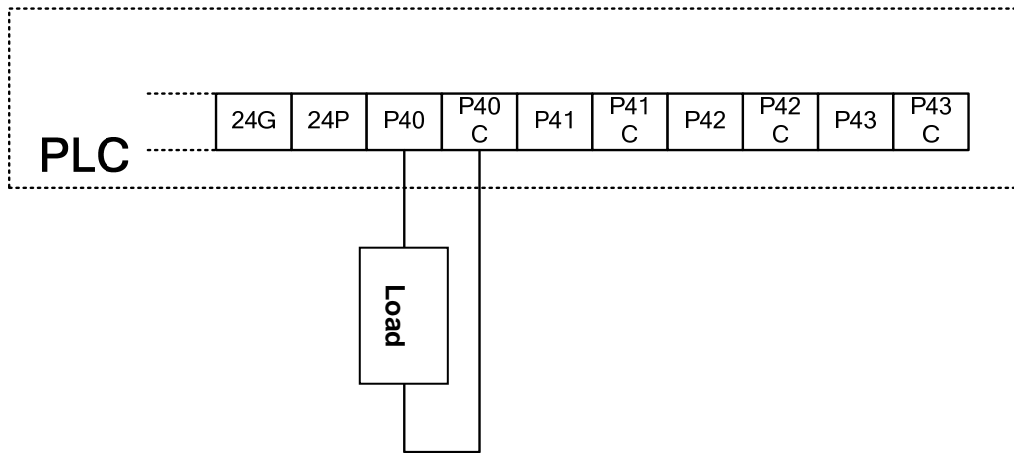

1) Output functions of PLC option under inverter LV (low voltage) trip (default)

When the iS7 inverter is tripped by LV (low voltage), the contacts which have been ON remain the ON status.

When the iS7 inverter is fully discharged and the power supply to the control board of this product is cut-off, the outputs from the contact points become OFF. (Note: larger iS7 inverter capacity gives longer time from LV trip to power supply cut-off to the control board).

The above describes the default specifications of this product.

2) Output functions of PLC option under inverter LV (low voltage) trip (application)

If the inverter has large capacity, the time elapsed from the inverter's LV trip to the power supply to the control board of this product is cut-off is relatively long, e.g., 10 or more seconds. Therefore, according to the requirement of the installation, the output contacts of this product may have to be isolated before the said time. The method of cutting off the output of this product at the time of LV trip of inverter is described in page 7-27~28.

(7) Terminal resistance for RS485 communication (J2 in the outline drawing)

If the J2 jumper is set to ON, terminal resistance of 120 ohm is inserted between the internal communication (Modbus-RTU) lines (S+, S-). When this product is installed at the terminal of a communication system, set the terminal resistance jumper J2 to ON. This will adjust the impedance between the communication lines to improve the distortion and attenuation of the RS485 communication signals caused by the delay in data transmission.

(8) Battery Housing

1) Battery specification

Coin-type, lithium ion battery (Type: CR2032).

2) Service life of battery

A new battery (capacity 220mAh, at 20 °C) can supply power to this product for about 4 years without external power supply. When the external power supply is ON, the battery is not discharged.

3) Data maintained by battery power during external power failure

- all the data in the latch area set up by KGLWIN
- clock data (internal RTC)

4) Battery discharge check

Turn on the power of this product. Go to No. 73 (Real Time) in the CNF group of the iS7 inverter using the loader of the iS7. If the present time is "2000/01/01 00:00," the battery needs to be replaced. The same will be displayed at power turn OFF/ON if no battery is installed.

5) Battery replacement

- Turn the power supply of the iS7 inverter to OFF.
- Remove iS7 inverter cover. Remove the cover of this product, too.
- Remove discharged battery carefully.
- Insert a new battery and push it down with a thumb.
- Turn on the power of the iS7 inverter.
- Connect CON1 with the RS232C cable. In the KGLWIN menu, select "Online → Write Data → Clock Data." Enter present time and check that the time displayed on the CNF73(Real Time) is correct.

7.2 Functions of PLC Option Card exclusively for iS7 Inverter

7.2.1 List of the special D registers for iS7 inverter control and monitoring

Classification	Area	Description	Ref. Page
Control	D4454	Using the digital loader of the inverter, register the addresses (see Appendix, page 4, App. 4-6, 4-7) of the parameters (max. 8) of the common area of the inverter, which will be controlled by the PLC option card, in the APO60~67 (PLC Wr Data 1~8). These inverter parameters corresponding to the registered addresses (max. 8) can be modified by writing specific values in the special area registers (D4454:APO60 , D4455:APO61 , D4456:APO62 , D4457:APO63 , D4458:APO64 , D4459:APO65 , D4460:APO66 , D4461:APO67) allocated to each parameter.	7-11 ~ 7-17
	D4455		
	D4456		
	D4457		
	D4458		
	D4459		
	D4460		
	D4461		
Monitoring	D4474	Using the digital loader of the inverter, register the addresses (see Appendix, page 4, App. 4-1, 4-5) of the parameters (max. 8) of the common area of the inverter, which will be controlled by the PLC option card, in the APO76~83 (PLC Rd Data 1~8). Read the inverter parameters in the addresses (max. 8) and write them in the PLC special area registers (D4474:APO76 , D4475:APO77 , D4476:APO78 , D4477:APO79 , D4478:APO80 , D4479:APO81 , D4480:APO82 , D4481:APO83) allocated to each of them.	7-18 ~ 7-24
	D4475		
	D4476		
	D4477		
	D4478		
	D4479		
	D4480		
	D4481		
	D4490	iS7 Inverter Trip Information -1	7-25 ~ 7-26
	D4491	iS7 Inverter Trip Information -2	
	D4492	iS7 Inverter Trip Information -3	
D4493	iS7 Inverter Trip Information -4		

7.2.2 Control (PLC Option → Inverter)

(1) iS7 Inverter Frequency Reference

PLC option can change the inverter’s frequency reference. Here, the DRV07 (Freq Ref Src) must be set to “PLC.”

▶ **Common area of the iS7 inverter**

Referring to the parameters (exclusively for control) of inverter common area in the “App. 4-6, page 4, Appendix,” the addresses of the common area of the inverter frequency reference are as follows.

Common Area Address	Name	Remark
0x380	Inverter Command Freq.	Common Area (Write) address for iS7

▶ **Special D registers of PLC for inverter control corresponding to APO60 ~ 67**

Register	Use of the Register	Remark
D4454	Data to be inputted in the common area parameter address set up by APO60 (PLC Wr Data1)	PLC Option→Inverter(control)
D4455	Data to be inputted in the common area parameter address set up by APO61 (PLC Wr Data2)	PLC Option→Inverter(control)
D4456	Data to be inputted in the common area parameter address set up by APO62 (PLC Wr Data3)	PLC Option→Inverter(control)
D4457	Data to be inputted in the common area parameter address set up by APO63 (PLC Wr Data4)	PLC Option→Inverter(control)
D4458	Data to be inputted in the common area parameter address set up by APO64 (PLC Wr Data5)	PLC Option→Inverter(control)
D4459	Data to be inputted in the common area parameter address set up by APO65 (PLC Wr Data6)	PLC Option→Inverter(control)
D4460	Data to be inputted in the common area parameter address set up by APO66 (PLC Wr Data7)	PLC Option→Inverter(control)
D4461	Data to be inputted in the common area parameter address set up by APO67 (PLC Wr Data8)	PLC Option→Inverter(control)

▶ **Application and exemplary program**

1) Set up the inverter parameters as shown below. In the APO60(PLC Wr Data1), enter the “0380Hex” which is the address (page 4, “App. 4-6, Appendix) of the common area of the inverter frequency reference.

Code	Function Name	Setting Value
DRV07	Freq Ref Src	PLC
APO60	PLC Wr Data1	0380 Hex

2) APO60 (PLC Wr Data1) corresponds with D4454 which is the special register of the PLC option by 1:1 relation. Since the APO60 (PLC Wr Data1) is registered with the common area address (0380Hex) of the inverter frequency reference, a specific value inputted in the D4454 in ladder program, the value will be the frequency reference of the inverter.

In the sample ladder program below, if the contact point of the M0000 is ON, the inverter will be set up with the frequency reference of 37.00Hz.



Chapter 7 Exclusive Functions for iS7 Inverter Control/Monitoring

(2) iS7 Inverter Operation Reference

PLC option can provide operation reference to an inverter.

► Common area of inverter

Referring to the parameters (exclusively for control) of inverter common area in the “App. 4-6, page 4, Appendix,” the addresses of the common area of the inverter operation reference are as follows.

Common Area Address	Function	Detailed Description	
0x0382	Inverter Run Command	BIT0	0: Stop command 1: Run command
		BIT1	0: Reverse operation 1: Forward operation
		BIT2	0→1 : Fault Reset
		BIT3	0→1 : Free-run to stop 1→0: Fault reset of Free-run to stop

► Special D registers of PLC for inverter control corresponding to APO60 ~ 67

Register	Use of the Register	Remark
D4454	Data to be inputted in the common area parameter address set up by APO60 (PLC Wr Data1)	PLC Option→Inverter(control)
D4455	Data to be inputted in the common area parameter address set up by APO61 (PLC Wr Data2)	PLC Option→Inverter(control)
D4456	Data to be inputted in the common area parameter address set up by APO62 (PLC Wr Data3)	PLC Option→Inverter(control)
D4457	Data to be inputted in the common area parameter address set up by APO63 (PLC Wr Data4)	PLC Option→Inverter(control)
D4458	Data to be inputted in the common area parameter address set up by APO64 (PLC Wr Data5)	PLC Option→Inverter(control)
D4459	Data to be inputted in the common area parameter address set up by APO65 (PLC Wr Data6)	PLC Option→Inverter(control)
D4460	Data to be inputted in the common area parameter address set up by APO66 (PLC Wr Data7)	PLC Option→Inverter(control)
D4461	Data to be inputted in the common area parameter address set up by APO67 (PLC Wr Data8)	PLC Option→Inverter(control)

► Application and exemplary program

- 1) 1) Set up the inverter parameters as shown below. In the APO60(PLC Wr Data1), enter the “0382Hex” which is the address (page 4, “App. 4-6, Appendix) of the common area of the inverter operation reference.

Code	Function Name	Set Value
DRV01	Cmd Frequency	11.52 Hz
DRV06	Cmd Source	PLC
DRV07	Freq Ref Src	Keypad-1
APO60	PLC Wr Data1	0382 Hex

- 2) APO60 (PLC Wr Data1) corresponds with D4454 which is the special register of the PLC option by 1:1 relation. Since the APO60 (PLC Wr Data1) is registered with the common area address (0382Hex) of the inverter operation reference, a specific value inputted in the D4454 in ladder program, the value will be the operation reference of the inverter.

Chapter 7 Exclusive Functions for iS7 Inverter Control/Monitoring

3) In the ladder program below, when the M0002 contact is ON, the inverter operates forward at the frequency of 11.52Hz (frequency 11.52Hz reference from keypad).

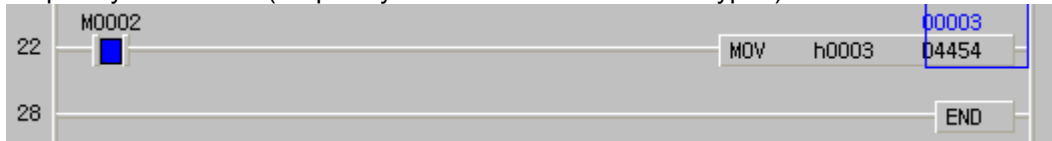

(3) Using inverter digital output contact points (basic 10: 3 points, with 10 extensions: basic 10 + 3 points) as the digital output contact points of PLC option.

◎ Number of output contact points (iS7 internal output points + extended IO output points)

Type	Number of Digital Output points
Basic I/O/O	2 points (Relay output)+1point (TR output)
Expansion I/O	3points (Relay output)
Total points	6 points

The digital output points (relay output contact points) of PLC option is 4 points. If more digital output points are required, you can make use of extended digital output points (3 relay output points) in addition to the points (2 relay points, 1 TR points) built in the inverter. In detail, in addition to the 4 basic digital output points (relay outputs) built-in the PLC option card, 6 output points (9 relay points, 1 TR point) comprising the 3 basic digital output points (2 relay points, 1 TR point) built-in the iS7 inverter and the 3 relay output points of the extension I/O board are available for the PLC option.

► Inverter parameter setting

The inverter digital output to be used by the PLC option must be set to “None.”

Code	Function Name	Set Value
OUT31	Relay 1	None
OUT32	Relay 2	None
OUT33	Q1	None

► Common area of inverter

Referring to the parameters (exclusively for control) of inverter common area in the “App. 4-6, page 4, Appendix,” the addresses of the common area of the inverter’s digital outputs are as follows.

Common Area Address	Function	Detailed Description		Remark
0x0386	Inverter Digital Output	BIT0	0: Relay1 OFF 1: Relay1 ON	0x0386
		BIT1	0: Relay2 OFF 1: Relay2 ON	
		BIT2	0: Q1 OFF 1: Q1 ON	
		BIT3	0: Q2 OFF 1: Q2 ON	
		BIT4	0: Q3 OFF 1: Q3 ON	
		BIT5	0: Q4 OFF 1: Q4 ON	

Chapter 7 Exclusive Functions for iS7 Inverter Control/Monitoring

► Special D registers of PLC for inverter control corresponding to APO60 ~ 67

Register	Use of the Register	Remark
D4454	Data to inputted in the common area parameter address set up by AP060 (PLC Wr Data 1).	PLC option → Inverter (Control)
D4455	Data to inputted in the common area parameter address set up by AP061 (PLC Wr Data 2).	PLC option → Inverter (Control)
D4456	Data to inputted in the common area parameter address set up by AP062 (PLC Wr Data 3).	PLC option → Inverter (Control)
D4457	Data to inputted in the common area parameter address set up by AP063 (PLC Wr Data 4).	PLC option → Inverter (Control)
D4458	Data to inputted in the common area parameter address set up by AP064 (PLC Wr Data 5).	PLC option → Inverter (Control)
D4459	Data to inputted in the common area parameter address set up by AP065 (PLC Wr Data 6).	PLC option → Inverter (Control)
D4460	Data to inputted in the common area parameter address set up by AP066 (PLC Wr Data 7).	PLC option → Inverter (Control)
D4461	Data to inputted in the common area parameter address set up by AP067 (PLC Wr Data 8).	PLC option → Inverter (Control)

► Application and exemplary program

1) Set up the inverter parameters as follows. In the APO60 (PLC Wr Data1), enter 0386Hex which is the common area address of the inverter digital output (page 4, “App. 4-6, Appendix).

Code	Function Name	Set Value
OUT31	Relay 1	None
OUT32	Relay 2	None
APO60	PLC Wr Data1	0386 Hex

2) APO60 (PLC Wr Data1) corresponds with the D4454 which is the special register of PLC option by 1:1 relation. Since the APO60 (PLC Wr Data1) is currently registered with the common area address (0386Hex) of the virtual multi-function output of the inverter, if a specific value is entered in the D4454 by the ladder program, the value will be the digital output of the inverter.

3) In the sample program below, if D4454 is written with h0003, 30A-30C of Relay1 and AXA-AXC of Relay2 are short-circuited. And then, if D4454 is written with h0000, the 30A-30C and AXA-AXC of Relay2 are opened.



(4) Writing other common area parameters frequently used

(e.g.: acceleration and deceleration times, etc.)

PLC option can write all the common area parameters of inverter.

In this manual, PLC option will set up (write) acceleration and deceleration times.

► Inverter common area

Referring to the parameters (exclusively for control) of inverter common area in the “App. 4-6, page 4, Appendix,” the addresses of the common area of the inverter acceleration and deceleration time are as follows.

Common Area Address	Function	Detailed Description
0x0383	Acceleration Time	Setting of Acceleration Time
0x0384	Deceleration Time	Setting of Deceleration Time

► Special D registers of PLC for inverter control corresponding to APO60 ~ 67

Register	Use of the Register	Remark
D4454	Data to inputted in the common area parameter address set up by AP060 (PLC Wr Data 1).	PLC option → Inverter (Control)
D4455	Data to inputted in the common area parameter address set up by AP061 (PLC Wr Data 2).	PLC option → Inverter (Control)
D4456	Data to inputted in the common area parameter address set up by AP062 (PLC Wr Data 3).	PLC option → Inverter (Control)
D4457	Data to inputted in the common area parameter address set up by AP063 (PLC Wr Data 4).	PLC option → Inverter (Control)
D4458	Data to inputted in the common area parameter address set up by AP064 (PLC Wr Data 5).	PLC option → Inverter (Control)
D4459	Data to inputted in the common area parameter address set up by AP065 (PLC Wr Data 6).	PLC option → Inverter (Control)
D4460	Data to inputted in the common area parameter address set up by AP066 (PLC Wr Data 7).	PLC option → Inverter (Control)
D4461	Data to inputted in the common area parameter address set up by AP067 (PLC Wr Data 8).	PLC option → Inverter (Control)

► Application and exemplary program

1) Set up inverter parameters as follows; in the APO60 (PLC Wr Data1), enter 0383Hex which is the common area address (page 4, “App. 4-6, Appendix) of inverter acceleration time, and in the APO61 (PLC Wr Data2), enter 0384Hex which is the common area address (page 4, “App. 4-6, Appendix) of inverter deceleration time.

Code	Function Name	Set Value
APO60	PLC Wr Data1	0383 Hex
APO61	PLC Wr Data2	0384 Hex

Chapter 7 Exclusive Functions for iS7 Inverter Control/Monitoring

3) The APO60 (PLC Wr Data1) and APO61 (PLC Wr Data2) correspond to D4454 and D4455 which are the special registers of PLC option, respectively, by 1:1 relation.

Because, the APO60 (PLC Wr Data1) and APO61 (PLC Wr Data2) are registered with the common area address (0383Hex) of inverter acceleration time and the common area address (0384Hex) of inverter deceleration time, respectively, if a specific value is entered in D4454 or D4455, the value will be inverter's acceleration or deceleration time, respectively.

2) When the sample program below is executed, inverter acceleration time (DRV03:Acc Time) will be changed to 12.5sec and the deceleration time (DRV04:Dec Time) will be changed to 14.3sec.

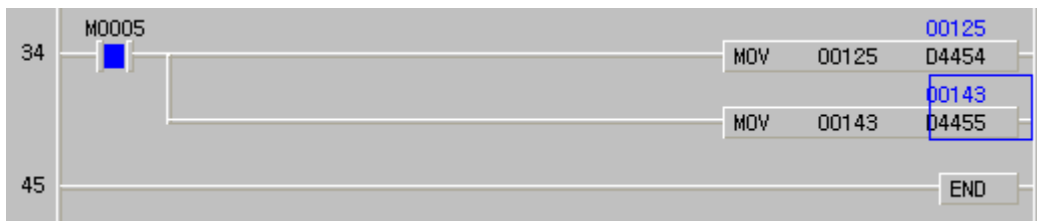

7.2.3 Monitoring (PLC Option ← Inverter)

(1) Using inverter digital input points as the digital input points of PLC option

Maximum 11 digital input points of inverter (with basic 10 points mounted: 8 points, with 10 extension points: basic 10 + 3 points) can be used as the digital input points of PLC option. Or, the status (0 or 1) of inverter digital input points can be used simply for monitoring function.

► Common area of inverter

Referring to the parameters (exclusively for monitoring) of inverter common area in the “App. 4-2, page 4, Appendix,” the addresses of the common area of the inverter digital input status are as follows.

Common Area Address	Function	Detailed Description		Remark
0320 Hex	Information of Inverter Digital Input Point	BIT0	0: P1 OFF 1: P1 ON	Built-in (IN65)
		BIT1	0: P2 OFF 1: P2 ON	Built-in (IN66)
		BIT2	0: P3 OFF 1: P3 ON	Built-in (IN67)
		BIT3	0: P4 OFF 1: P4 ON	Built-in (IN68)
		BIT4	0: P5 OFF 1: P5 ON	Built-in (IN69)
		BIT5	0: P6 OFF 1: P6 ON	Built-in (IN70)
		BIT6	0: P7 OFF 1: P7 ON	Built-in (IN71)
		BIT7	0: P8 OFF 1: P8 ON	Built-in (IN72)
		BIT8	0: P9 OFF 1: P9 ON	In case expansion I/O is installed (IN73)
		BIT9	0: P10 OFF 1: P10 ON	In case expansion I/O is installed (IN74)
		BIT10	0: P11 OFF 1: P11 ON	In case expansion I/O is installed (IN75)

► Special D registers of PLC for inverter status monitoring corresponding to APO76 ~ 83

Register	Use of the Register	Remark
D4474	Data of common area parameter address is saved set up by APO76 (PLC Rd Data1).	Inverter → PLC option (Monitoring)
D4475	Data of common area parameter address is saved set up by APO77 (PLC Rd Data2).	Inverter → PLC option (Monitoring)
D4476	Data of common area parameter address is saved set up by APO78 (PLC Rd Data3).	Inverter → PLC option (Monitoring)
D4477	Data of common area parameter address is saved set up by APO79 (PLC Rd Data4).	Inverter → PLC option (Monitoring)
D4478	Data of common area parameter address is saved set up by APO80 (PLC Rd Data5).	Inverter → PLC option (Monitoring)
D4479	Data of common area parameter address is saved set up by APO81 (PLC Rd Data6).	Inverter → PLC option (Monitoring)
D4480	Data of common area parameter address is saved set up by APO82 (PLC Rd Data7).	Inverter → PLC option (Monitoring)
D4481	Data of common area parameter address is saved set up by APO83 (PLC Rd Data8).	Inverter → PLC option (Monitoring)

► Application and exemplary program

- 1) Set up inverter parameters as follows. Especially, enter 320Hex which is the inverter digital input status address (App. 4-2. page 4, Appendix) in the APO76 (PLC Rd Data1).

Code	Function Name	Set Value
APO76	PLC Rd Data1	0320 Hex

Chapter 7 Exclusive Functions for iS7 Inverter Control/Monitoring

- 2) The APO76 (PLC Rd Data1) corresponds by 1:1 with the D4474 which is the special register of PLC option. Therefore, the value in the D4474 is the data (inverter digital input status) stored in the 0320Hex which is the address of the inverter digital input status registered in the APO76 (PLC Rd Data1).
- 3) For an example with the ladder program below, PLC option can monitor the digital input status (0 or 1) of the inverter.

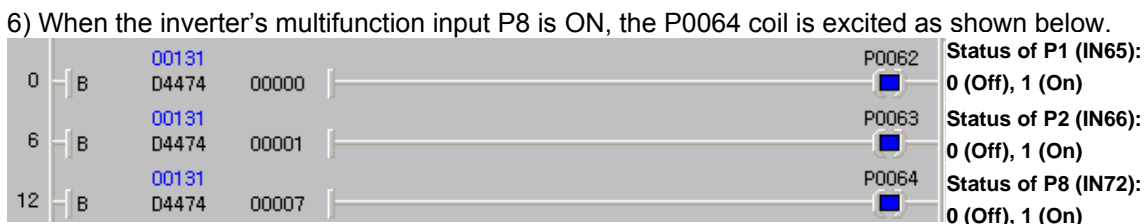
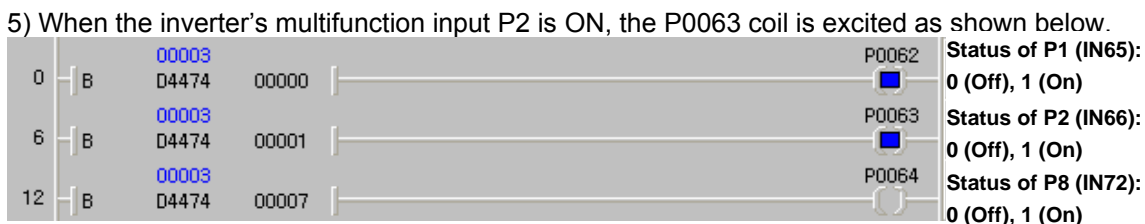
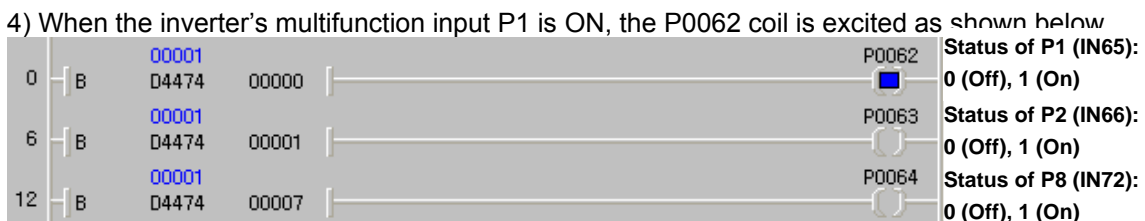

Caution

The scanning frequency of PLC option card reading the digital input points of inverter is approximately 10ms.

Chapter 7 Exclusive Functions for iS7 Inverter Control/Monitoring

(2) Monitoring inverter operation statuses (forward/reverse, constant speed, accelerating/decelerating, stopped, etc)

It is possible to monitor the operation status of iS7 inverter, and make out a ladder program for the sequence suitable for the operation status with PLC option card.

► Common area of inverter

Referring to the parameters (exclusively for monitoring) of inverter common area in the “App. 4-1, page 4, Appendix,” the addresses of the common area of the inverter operation status are as follows.

Common Area Address	Function	Detailed Description	
0305 Hex	Inverter Operation Status	BIT0	0: Stop
		BIT1	1: Forward operation
		BIT2	2: Reverse operation
		BIT3	3: DC operation (or 0 speed control)
		BIT4	1: During speed searching
		BIT5	2: Accelerating
		BIT6	3: Constant speed
		BIT7	4: Decelerating
			5: Deceleration to stop
			6: During H/W OC restraint
			7: During S/W OC restraint
		BIT8	8: Dwell operating
Reserved			
Reserved			
Reserved			
BIT8	0: Normal Status		
BIT9	4: Warning Status		
BIT10	8: Fault Status		
BIT11			

► Special D registers of PLC for inverter status monitoring corresponding to APO76 ~ 83

Register	Use of the Register	Remark
D4474	Data of common area parameter address is saved set up by APO76 (PLC Rd Data1).	Inverter → PLC option (Monitoring)
D4475	Data of common area parameter address is saved set up by APO77 (PLC Rd Data2).	Inverter → PLC option (Monitoring)
D4476	Data of common area parameter address is saved set up by APO78 (PLC Rd Data3).	Inverter → PLC option (Monitoring)
D4477	Data of common area parameter address is saved set up by APO79 (PLC Rd Data4).	Inverter → PLC option (Monitoring)
D4478	Data of common area parameter address is saved set up by APO80 (PLC Rd Data5).	Inverter → PLC option (Monitoring)
D4479	Data of common area parameter address is saved set up by APO81 (PLC Rd Data6).	Inverter → PLC option (Monitoring)
D4480	Data of common area parameter address is saved set up by APO82 (PLC Rd Data7).	Inverter → PLC option (Monitoring)
D4481	Data of common area parameter address is saved set up by APO83 (PLC Rd Data8).	Inverter → PLC option (Monitoring)

Chapter 7 Exclusive Functions for iS7 Inverter Control/Monitoring

► Application and exemplary program

1) Set up inverter parameters as follows. Especially, enter 0305Hex which is the address of the inverter operation status (app. 4-1, page 4, Appendix) in the APO76 (PLC Rd Data1).

Code	Function Name	Set Value	Remark
DRV01	Cmd Frequency	12.00 Hz	-
DRV06	Cmd Source	Keypad	-
DRV07	Freq Ref Src	Keypad-1	-
APO76	PLC Rd Data1	0305 Hex	-

2) The APO76 (PLC Rd Data1) corresponds by 1:1 with the PLC option's special register D4474. Therefore, the value in the D4474 is the data (current operation status of the inverter) stored in 0305Hex which is the address of the inverter operation status registered in the APO76 (PLC Rd Data1).

3) For an example with the ladder program below, PLC option can monitor the current operation status (stop, accelerating, decelerating, constant speed, etc.) of the inverter.

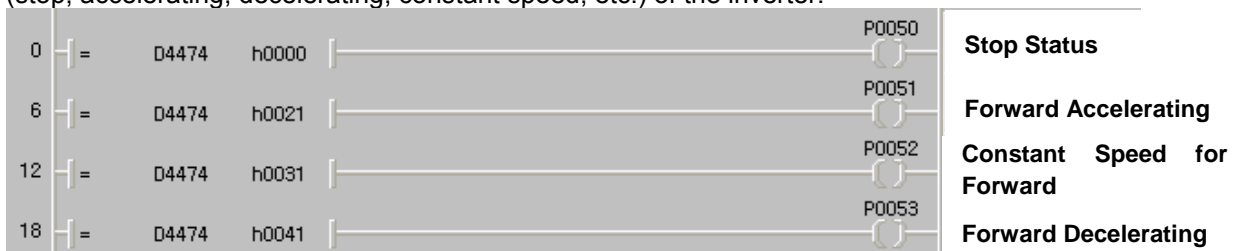

4) In stopped status, the D4474 is "h0000" (see common area of inverter)

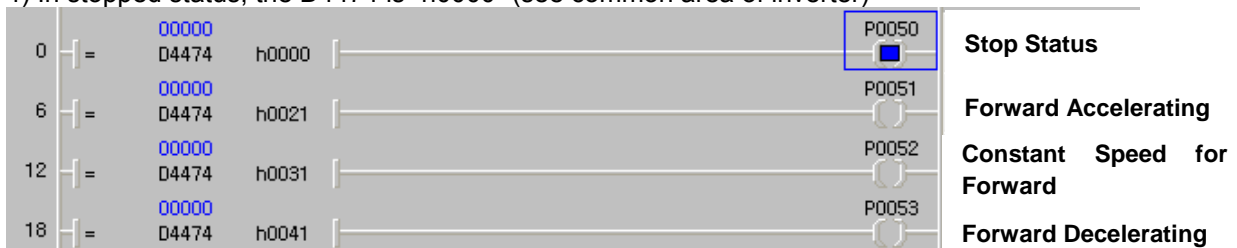

5) Now, press the FWD key on the digital loader of the inverter to provide it with forward operation reference. During forward operation, the D4474 is h0021 (see common area of inverter)



Chapter 7 Exclusive Functions for iS7 Inverter Control/Monitoring

6) During forward constant speed, the D4474 is h0031 (see common area of inverter)



7) With the digital loader of the inverter, change DRV01 (Cmd Frequency) to 5.00 Hz for forward deceleration. During forward deceleration, the D4474 is h0041 (see common area of inverter)



(3) Monitoring the current output frequency of inverter

It is possible to monitor the current output frequency of iS7 inverter, and make out a ladder program for the sequence suitable for the operation frequency in PLC option card.

► Common area of inverter

Referring to the parameters (exclusively for monitoring) of inverter common area in the “App. 4-1, page 4, Appendix,” the addresses of the common area of the inverter’s current output frequencies are as follows.

Common Area Address	Function	Detailed Description
0x0311	Output Frequency	Current Output Frequency Monitoring

► Special D registers of PLC for inverter status monitoring corresponding to APO76 ~ 83

Register	Use of the Register	Remark
D4474	Data of common area parameter address is saved set up by APO76 (PLC Rd Data1).	Inverter → PLC option (Monitoring)
D4475	Data of common area parameter address is saved set up by APO77 (PLC Rd Data2).	Inverter → PLC option (Monitoring)
D4476	Data of common area parameter address is saved set up by APO78 (PLC Rd Data3).	Inverter → PLC option (Monitoring)
D4477	Data of common area parameter address is saved set up by APO79 (PLC Rd Data4).	Inverter → PLC option (Monitoring)
D4478	Data of common area parameter address is saved set up by APO80 (PLC Rd Data5).	Inverter → PLC option (Monitoring)
D4479	Data of common area parameter address is saved set up by APO81 (PLC Rd Data6).	Inverter → PLC option (Monitoring)
D4480	Data of common area parameter address is saved set up by APO82 (PLC Rd Data7).	Inverter → PLC option (Monitoring)
D4481	Data of common area parameter address is saved set up by APO83 (PLC Rd Data8).	Inverter → PLC option (Monitoring)

Chapter 7 Exclusive Functions for iS7 Inverter Control/Monitoring

► Application and exemplary program

- 1) Set up inverter parameters as follows. Especially, enter 0311Hex which is the address of the inverter's current output frequency (app. 4-1, page 4, Appendix) in the APO76 (PLC Rd Data1).

Code	Function Name	Set Value	Remark
DRV01	Cmd Frequency	29.00 Hz	-
DRV06	Cmd Source	Keypad	-
DRV07	Freq Ref Src	Keypad-1	-
APO76	PLC Rd Data1	0311 Hex	-

- 2) The APO76 (PLC Rd Data1) corresponds by 1:1 with the PLC option's special register D4474. Therefore, the value in the D4474 is the data (current output frequency of the inverter) stored in 0311Hex which is the address of the inverter output frequency registered in the APO76 (PLC Rd Data1).

- 3) For an example with the ladder program below, PLC option can monitor the current output frequency of the inverter.



- 4) Press FWD on the digital loader of the inverter for forward operation up to 29.00Hz.

- 5) The value 2900 is inputted into the D4474 as shown below.

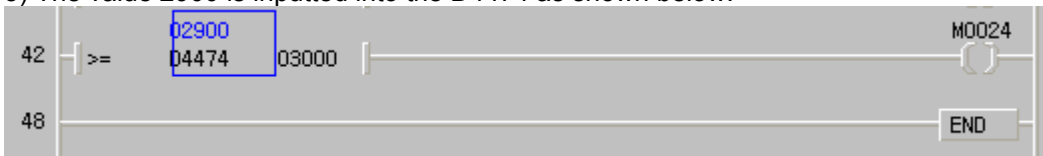

- 6) Set the DRV01 (Cmd Frequency) to 30.00Hz. Now, the D4474 is changed to 03000 and the M0024 relay is turned ON.

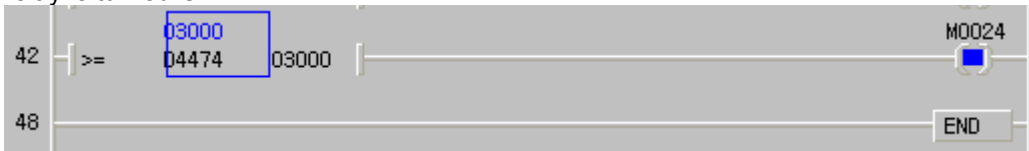

Chapter 7 Exclusive Functions for iS7 Inverter Control/Monitoring

(4) Monitoring the current trip status of iS7 inverter

PLC option card can monitor up to 4 active trips of iS7 inverter. If a further trip occurs, it will over-write the oldest trip.

◎ iS7 inverter trip list

Trip No.	Trip Type	Trip No.	Trip Type	Trip No.	Trip Type	Trip No.	Trip Type
0	HW Diag	16	-	32	Opt1(Slot1) Trip	48	-
1	Arm Short	17	NTC	33	Opt2(Slot2) Trip	49	-
2	OC	18	Fan Lock	34	Opt3(Slot3) Trip	50	-
3	OV	19	IPO	35	IO Board Trip	51	-
4	External Trip	20	UL	36	Expansion IO Trip	52	-
5	-	21	PTC	37	-	53	-
6	Fuse Open	22	Para WR Trip	38	-	54	-
7	Ground Fault	23	Pre PID Fail	39	-	55	-
8	OH	24	-	40	Encoder Board Trip	56	-
9	Eth	25	-	41	Over Speed	57	-
10	OL	26	-	42	Speed Deviation Trip	58	-
11	-	27	-	43	External Brake	59	-
12	-	28	-	44	-	60	BX
13	-	29	-	45	HW OCS	61	LV
14	PO	30	-	46	-	62	Lost Cmd (Comm.)
15	IOL	31	-	47	-	63	Lost Cmd (Keypad)
-	-	-	-	-	-	255	No Trip

► Special D register of PLC for monitoring inverter trip information

Special Register	Description
D4490	Inverter Trip Save Area 1
D4491	Inverter Trip Save Area 2
D4492	Inverter Trip Save Area 3
D4493	Inverter Trip Save Area 4

When the iS7 inverter is powered on, the special D register (D4490~D4493) for inverter trip monitoring is initialized to 0x00FF. The order of storing inverter trip information is D4490 → D4491 → D4492 → D4493. Up to 4 inverter trips can be stored, and the 5th will overwrite D4490, and the 6th will overwrite D4491. In this manner, new inverter trip data are stored in the special D register.

Chapter 7 Exclusive Functions for iS7 Inverter Control/Monitoring

► Application and exemplary program

1) Make out following program with the KGLWIN. Check that the IN68 (P4 Define) is set to External Trip, and turn on the multifunction input P4 to trigger an External Trip. The D4490 area becomes 4 (External trip), as shown below.



3) Check that the IN67 (P3 Define) is set to BX, and turn on the multifunction input P3 to create BX. The D4491 area becomes 60 (BX), as shown below.



Chapter 7 Exclusive Functions for iS7 Inverter Control/Monitoring

(5) Isolating PLC option output when the inverter is tripped by LV (Low Voltage)

As described in page 7-7, (6) Terminal output, the method of isolating PLC output when the inverter is tripped by LV (Low Voltage) is described below with an exemplary program.

► Common area of inverter

Referring to the parameters (exclusively for monitoring) of inverter common area in the “App. 4-4, page 4, Appendix,” the addresses of the common area of the inverter level type trip information are as follows.

Common Area Address	Function	Detailed Description	
0x332	Level Type Trip Information	BIT0	BX
		BIT1	LV
		BIT2	Lost Command
		BIT3	KPD Lost Command
		BIT4	-
		BIT5	-
		BIT6	-
		BIT7	-
		BIT8	-
		BIT9	-
		BIT10	-
		BIT11	-
		BIT8	-
		BIT9	-
BIT10	-		
BIT11	-		

► Special D registers of PLC for inverter status monitoring corresponding to AP076 ~ 83

Register	Use of the Register	Remark
D4474	Data to inputted in the common area parameter address set up by AP076 (PLC Rd Data 1).	Inverter → PLC option (Monitoring)
D4475	Data to inputted in the common area parameter address set up by AP077 (PLC Rd Data 2).	Inverter → PLC option (Monitoring)
D4476	Data to inputted in the common area parameter address set up by AP078 (PLC Rd Data 3).	Inverter → PLC option (Monitoring)
D4477	Data to inputted in the common area parameter address set up by AP079 (PLC Rd Data 4).	Inverter → PLC option (Monitoring)
D4478	Data to inputted in the common area parameter address set up by AP080 (PLC Rd Data 5).	Inverter → PLC option (Monitoring)
D4479	Data to inputted in the common area parameter address set up by AP081 (PLC Rd Data 6).	Inverter → PLC option (Monitoring)
D4480	Data to inputted in the common area parameter address set up by AP082 (PLC Rd Data 7).	Inverter → PLC option (Monitoring)
D4481	Data to inputted in the common area parameter address set up by AP083 (PLC Rd Data).	Inverter → PLC option (Monitoring)

Chapter 7 Exclusive Functions for iS7 Inverter Control/Monitoring

► Application and exemplary program

1) Set up inverter parameters as follows.

Code	Function Name	Set Value	Remark
OUT30	Trip Out Mode	011	If the BIT0 of OUT30 is 1, the LV trip signal (1 for trip trigger, 0 for trip reset) is sent to PLC option via the common area (0x332).
APO76	PLC Rd Data1	0332 Hex	Set up the common area address (0x332) which has level type trip data.

2) Make out following program with the KGLWIN. In normal operation status without LV trip, all of the P0040~P0043 contact point outputs are in ON status.

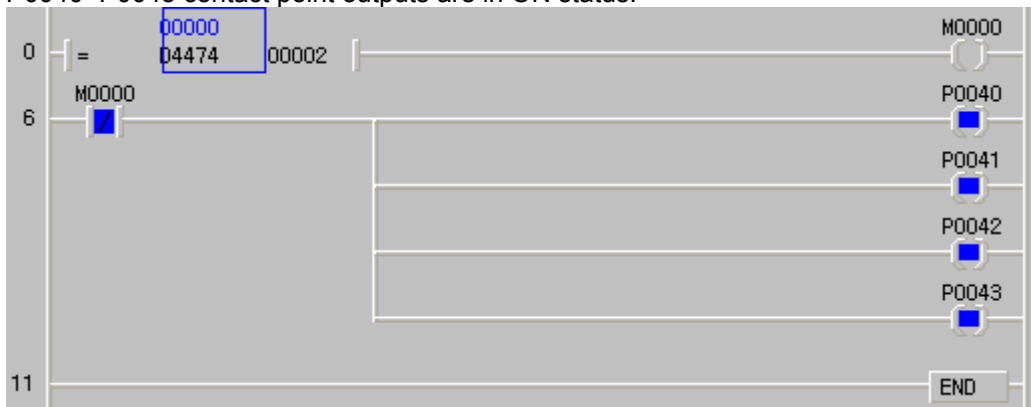

3) When inverter LV trip is triggered (the 2nd bit of the D4474 register in which the common area address 0x332 is registered is turned ON), the output from the P0000~P0040 points are turned OFF.

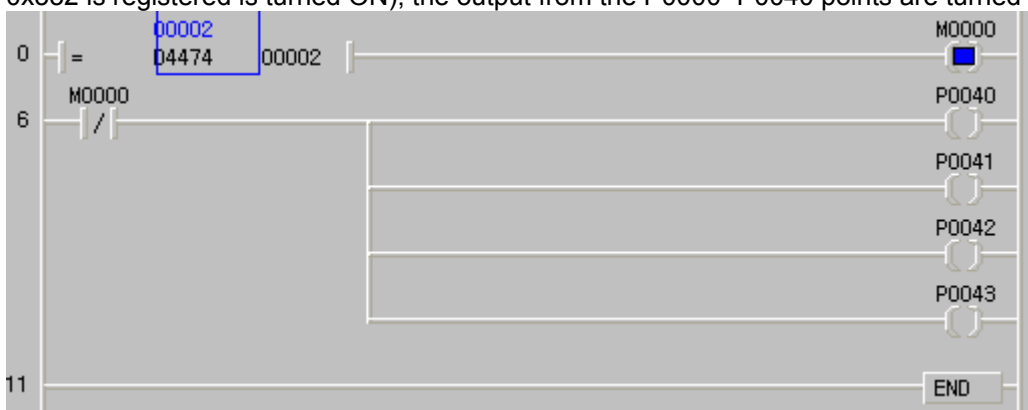

For a large capacity inverter, if the digital outputs of the PLC option must be isolated at the LV trip of the inverter, the above described method can be used.

Chapter 8 Modbus Communication

8.1 Modbus Communication

8.1 Introduction

PLC option card of iS7 inverters' built-in communication supports Modbus, the Modicon product's communication protocol. It supports ASCII mode, using ASCII data and RTU mode using Hex data. Function code used in Modbus is supported by instruction and especially function code 01, 02, 03, 04, 05, 06, 15 and 16. Refer to "Modicon Modbus Protocol Reference Guide"

8.1.2 Basic Specification

1) ASCII Mode

- (1) It communicates, using ASCII data.
- (2) Each frame uses ':' (colon: H3A)', for header, CRLF (Carriage Return-Line Feed : H0D H0A), for tail.
- (3) It allows Max. 1 second interval between characters.
- (4) It checks errors, using LRC.
- (5) Frame structure (ASCII data)

Item	Header	Address	Function code	Data	LRC	Tail (CR/LF)
Size	1 byte	2 bytes	2 bytes	n bytes	2 bytes	2 bytes

2) RTU mode

- (1) It communicates, using hex data.
- (2) There's no header and tail. It starts with address and finishes frame with CRC.
- (3) It has at least 3.5 character times between two frames.
- (4) It ignores the current frame when 1.5 character times elapse between characters.
- (5) It checks errors, using 16 bit CRC.
- (6) Frame structure (hex data)

Item	Address	Function code	Data	CRC
Size	1 byte	1 bytes	n bytes	2 bytes

Remark

- 1) The size constituting 1 letter is 1 character. So 1 character is 8 bits that is 1 byte.
- 2) 1 character time means the time lapsed for sending 1 character.
Ex) Calculation of 1 character time at 1200 bps.
1200 bps means that it takes 1 second to send 1200 bits.
To send 1 bit, $1 \text{ sec}/1200 \text{ bits} = 0.83 \text{ ms}$.
Therefore, 1 character time is $0.83\text{ms} * 8 \text{ bits} = 6.64\text{ms}$.
- 3) 584, 984 A/B/X executes frame division, using intervals of more than 1 sec without LRC in processing internally.

Chapter 8 Modbus Communication

3) Address area

- (1) PLC option card supports 0 to 31.

4) Function code area

- (1) PLC option card supports only 01, 02, 03, 04, 05, 06, 15, and 16 among Modicon products' function code.
- (2) If the response format is Confirm+(ACK), it uses the same function code.
- (3) If the response format is Confirm-(NCK), it returns as it sets the 8th bit of function code as 1.

Ex) If function code is 03,

- Only function code is written here because only function codes are different.

[Request]

0000 0011 (H03)

[Confirm+]

0000 0011 (H03)

[Confirm-]

1000 0011 (H83)

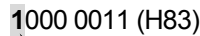

It returns as it sets the 8th bit of function code of request frame.

5) Data area

- (1) It sends data, using ASCII data (ASCII mode) or hex (RTU mode).
- (2) Data is changed according to each function code.
- (3) Response frame uses data area as response data or error code.

6) LRC Check/CRC Check area

- (1) LRC (Longitudinal Redundancy Check): It works in ASCII mode. It takes 2 complement from sum of frame except header or tail to change into ASCII code,
- (2) CRC (Cyclical Redundancy Check): It works in RTU mode. It uses 2-byte CRC check rules.

Remark

- 1) All numerical data can use hexadecimal, decimal, and binary type. If we convert decimal 7 and 10 into each type:

Hexadecimal: H07, H0A or 16#07, 16#0A

Decimal: 7, 10

Binary: 2#0111, 2#1010

Chapter 8 Modbus Communication

7) Function code type

Code	Function Code Name	Modicon PLC Data Address	Remark
01	Read Coil Status	0XXXX(bit-output)	Read bits
02	Read Input Status	1XXXX(bit-input)	Read bits
03	Read Holding Registers	4XXXX(word-output)	Read words
04	Read Input Registers	3XXXX(word-input)	Read words
05	Force Single Coil	0XXXX(bit-output)	Write bit
06	Preset Single Register	4XXXX(word-output)	Write word
15	Force Multiple Coils	0XXXX(bit-output)	Write bits
16	Preset Multiple Registers	4XXXX(word-output)	Write words

◆ PLC Option Card Mapping

Bit area		Word area	
Address	Data area	Address	Data area
h0000	P area	h0000	P area
h1000	M area	h1000	M area
h2000	L area	h2000	L area
h3000	K area	h3000	K area
h4000	F area	h4000	F area
h5000	T area	h5000	T area (current value area)
h6000	C area	h6000	C area (current value area)
-	-	h7000	S area
-	-	h8000	D area

8) Modbus addressing rules

PLC option card starts its address from 0 and matches with 1 of Modicon products' data address. So PLC option card address n matches n+1 of Modicon products' address. This means that the output contact point 1 (0001) of Modicon products is marked as communication address 0 and the input contact point 1 (0001) of Modicon products is marked as communication address 0 in PLC option card.

9) The size of using data

As for data size, PLC option card supports 128 bytes in ASCII mode and 256 bytes in RTU mode. The maximum size of the Modicon products is different from each other's kind. So refer to "Modicon Modbus Protocol Reference Guide."

Chapter 8 Modbus Communication

10) Wiring

Use S+ and S - terminals.

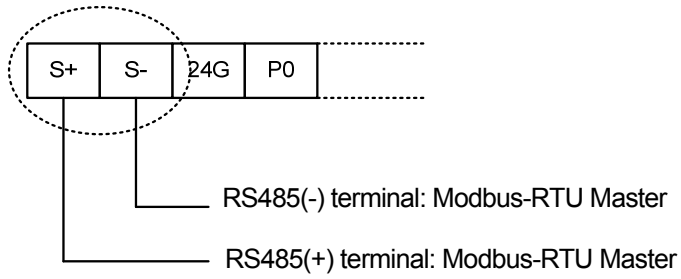

8.1.3 Parameter Setting

1) Setting communication parameter

(1) Open a new project file at KGLWIN.

- iS7 should be selected in PLC type.
- Open a new project file for each of the master and the slave.

(2) Select a communication parameter at KGLWIN and double click to open the following window.

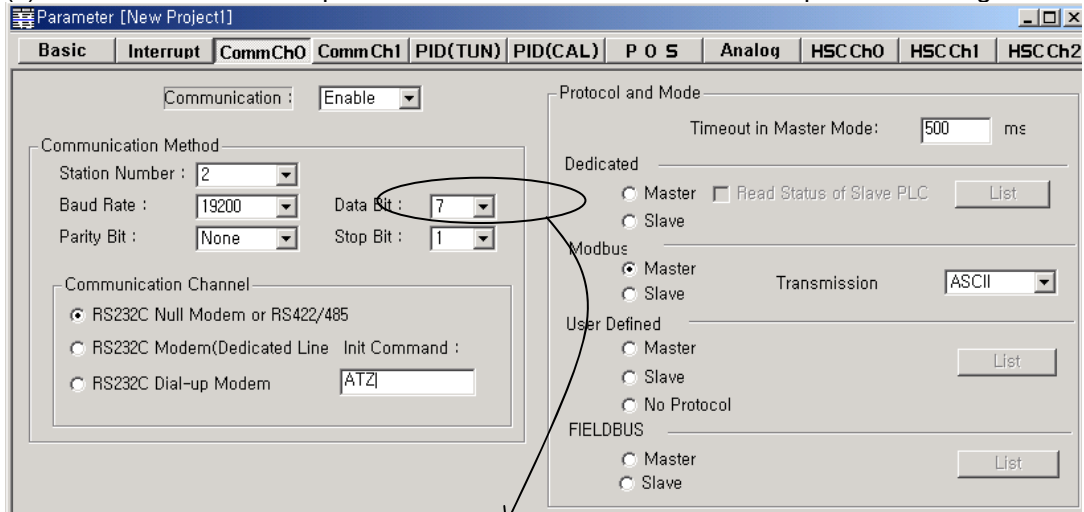

If communication mode is ASCII,
Be sure to set 7bit.

Chapter 8 Modbus Communication

Set the contents as follows.

Item	Setting contents
Station No.	Set a number between 0 to 31 (Don't assign no. 0 as broadcasting station lest it may be a cause for mistaken operation)
Baud Rate	Set one from 1200, 2400, 4800, 9600, 19200, 38400, or 57600 bps.
Data Bit	Set 7 or 8. ASCII mode: Set as 7 bits. RTU mode: Set as 8 bits.
Parity Bit	Set as one of None, Even, or Odd.
Stop Bit	Set 1 or 2 bit(s). When parity bit is set: Set as 1 bit. When parity bit isn't set: Set as 2 bits.
Time out in Master Mode	<ul style="list-style-type: none">• It's the time waiting a responding frame since the master MK80S main unit sends a request frame.• The default value is 500ms.• It must be set in consideration of the max. periodical time for sending/receiving of the master PLC.• If it's set smaller than the max. send/receive periodical time, it may cause communication error.
Modbus Master/ Slave	If it is set as the master, it's the subject in the communication system. If it's set as the slave, it only responds to the request frame of the master.
Transmission Mode	Select ASCII mode or RTU mode.

Chapter 8 Modbus Communication

8.1.4 Instruction

Instruction	Available device											No. of steps	Flag		
	M	P	K	L	F	T	C	S	D	#D	integer		Error (F110)	Zero (F111)	Carry (F112)
MODCOM	Ch											0			
	S1	0	0	0	0	0	0	0		0	0		0		
	S2	0	0	0	0		0	0		0	0				
	S3	0	0	0	0		0	0		0	0				

Flag

F110	Error flag turns On when #D area is over.
------	---

Designation

Ch	Designated communication channel (Ch 0, Ch 1)
S1	Device which is registered communication parameter
S2	Device which stored communication data
S3	Device which stored communication status

1) Function

- It transfer the saved data in designated S1 device via Modbus protocol. (3 Word)
- Designates the first address of the device which will store the received data in S2.
 - ➔ According to the S1 function code,
 - In case of reception, it designates the first address of device to store the received data.
 - In case of transmission, it designates the first address of device to store the trasmitted data.
- Communication status is saved in S3.

2) Program Example

<p style="margin-left: 20px;">F0012</p> <p style="margin-left: 20px;">M0020</p>	<pre> [MOV h0301 D0000] [MOV h0013 D0001] [MOV h0025 D0002] [MODCOM 1 D0000 D1000 M100] </pre>	<p>Designate slave station No. (Upper byte) and Function code (Lower byte) of reading.</p> <p>Designates the address.</p> <p>Designates number of reading.</p> <p>If M0020 turns On, it start the Modbus communication with stored modbus parameter in D000 via Channel 1 and save the received data at D1000. M100 saves the communication error information</p>
---	--	---

When it operates as slave selected in Modbus setting of parameter setting, PLC option card responses to master station without commands. And When operates as master, PLC option card sends data in S1 with MODBUS protocol at rising edges of execution condition.

Chapter 8 Modbus Communication

- S3 format is as below.

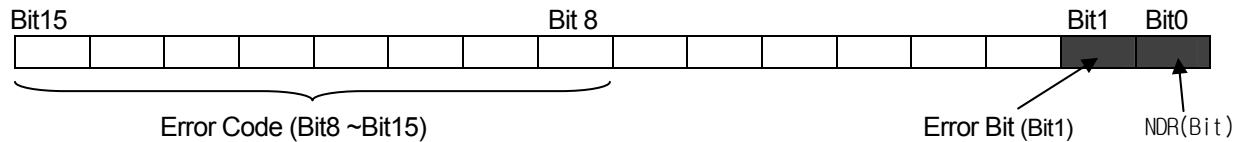

- NDR : when the communication ends normally, this bit turns on during 1 scan.
- Error bit: when communication error occurs, this bit turns on during 1 scan. At that time, error code stores bit 8 ~ bit 15.
- Error code : Displays the Error information. Refer to detailed description as below table.

Error Code Table

Code	Error type	Meaning
01	Illegal Function	Error in inputting function code in instruction.
02	Illegal Address	Error of exceeding the area limit of reading/writing on the slave station.
03	Illegal Data Value	Error when the data value to be read from or write on the slave station isn't allowed.
04	Slave Device Failure	Error status of the slave station.
05	Acknowledge	It's a responding code of the slave station for the master station to prevent the master station time-out error, when request command processing takes time. The master station marks an error code and waits for a certain time without making any second request.
06	Slave Device Busy	Error when request command processing takes too much time. The master should request again.
07	Time Out	Error when exceeds the time limit of the communication parameter as it communicates.
08	Number Error	Errors when data is 0 or more than 256 bytes
09	Parameter Error	Error of setting parameters (mode, master/ slave)
10	Station Error	Error when the station number of itself and the station number set by the S1 of instruction are the same.

Chapter 8 Modbus Communication

Example Program 1

The master reads status of the Coil 00020 ~ 00056 of the slave station no. 17. The Coil of the slave station is supposed to be as follows and the data that are read is saved in data register D1000.

Coil	59	58	57	56	55	54	53	52	51	50	49	48	47	46	45	44	43	42	41	40
Status	X	X	X	1	1	0	1	1	0	0	0	0	1	1	1	0	1	0	1	1
Hex	1			B				0				E				B				
Hex	39	38	37	36	35	34	33	32	31	30	29	28	27	26	25	24	23	22	21	20
Status	0	0	1	0	0	1	1	0	1	0	1	1	1	1	0	0	1	1	0	1
Hex	2			6				B				C				D				

The status of Coil 57, 58, 59 is redundancy.

Data is sent starting from the low bit by byte unit. If the deficient bit of a byte is filled with 0.

An example of sending the above data is as the following example 1.

Example 1) CD B2 0E 1B

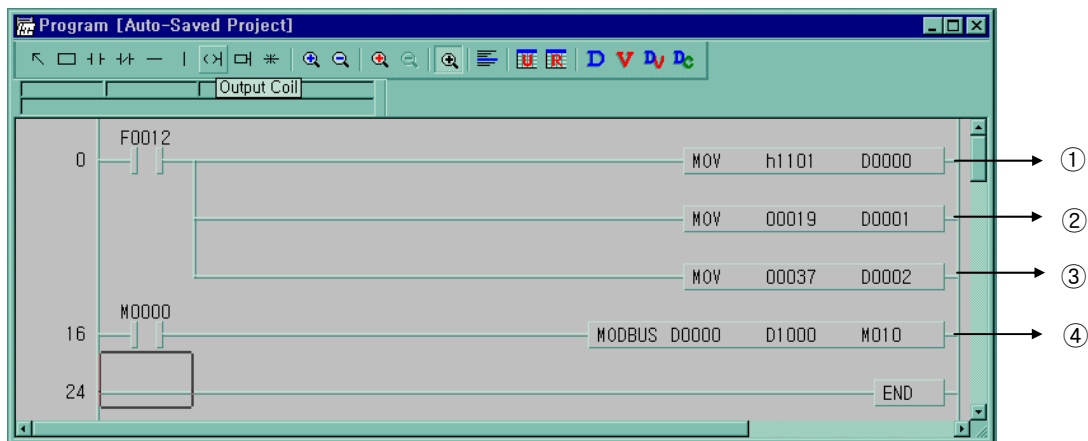

- ① It designates slave station and function code (No. of station : h11(17) , function code : h01)
- ② Address setting
 - Address '0' at MODBUS protocol means address '1' actually .So if you want to designate address '20', write address '19'
- ③ Reading number setting (Reading number is 37 from 20 to 56.)
- ④ This is MODBUS Communication instruction.

- Data is sent starting from the low bit by byte unit. If the deficient bit of a byte is filled with 0. An example of sending the above data is as follows.

Example 1) CD 6B B2 0E 1B

Device	Stored data
D1000	h CD 6B
D1001	h B2 CE
D1002	h 00 1B

Chapter 8 Modbus Communication

Example program 2

The master reads status of the input contact 10197 ~ 10218 of the slave station no. 17.

The input contact of the slave station is supposed to be as follows and the data that are read is saved in Internal relay M015.

Input	10220	10219	10218	10217	10216	10215	10214	10213	10212	10211	10210	10209
Status	X	X	1	1	0	1	0	1	1	1	0	1
Hex	3				5				D			
Input	10208	10207	10206	10205	10204	10203	10202	10201	10200	10199	10198	10197
Status	1	0	1	1	1	0	1	0	1	1	0	0
Hex	B				A				C			

- The status of input contact 10219, 10220 is redundancy
- Data is sent starting from the low bit by byte unit. If the deficient bit of a byte is filled with 0. An example of sending the above data is as follows.

Example 2) AC DB 35

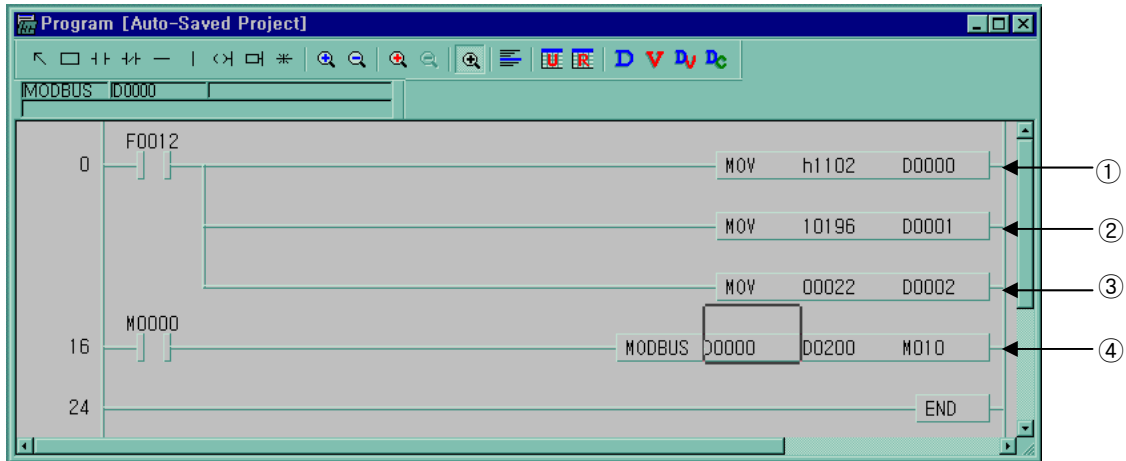

- ① It designates slave station and function code (No. of station : h11(17) , function code : h02)
- ② Address setting
 - Address '0' at MODBUS protocol means address '1' actually. So if you want to designate address '10197', write address '10196'
- ③ Reading number setting (Reading number is 22 from 10197 to 10220.)
- ④ This is MODBUS Communication instruction.
 - The data transmission starts lower byte. The remnant part of byte is filled with '0'
- ⑤ Stored data at D200, D201 are:

Device	Stored data
D200	h AC DB
D201	h 00 35

Chapter 8 Modbus Communication

Example Program 3

The master writes 4 words data of D1000 ~ D1003 to output register 40000 of the slave station no. 10.

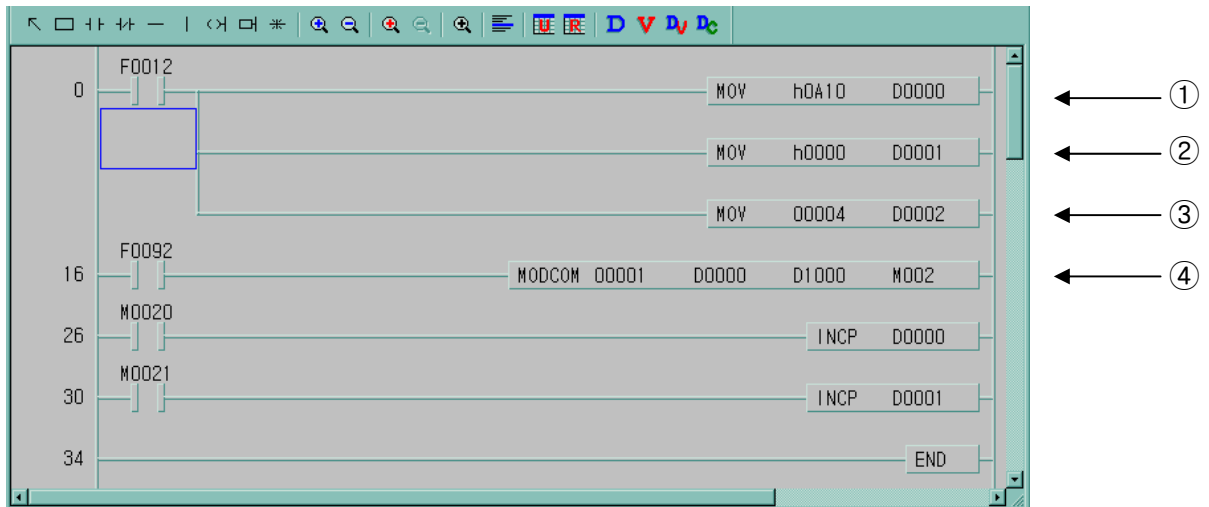

- ① It designates slave station and function code (No. of station: h0A(10) , function code : h10)
- ② Address setting
 - Address '0' of function code '16' at MODBUS protocol actually means address '40000'.
- ③ Writing number setting (Writing number is 4 because 4 words will be written.)
- ④ This is MODBUS Communication instruction.
 - It writes the 4 words data from D1000 to D1003 which the type is set in D0000 to D0002 via channel 1.

Chapter 8 Modbus Communication

Example Program 4

The master writes 1 word data of PLC option card in D1000 to output register 40000 of the slave station no. 10.

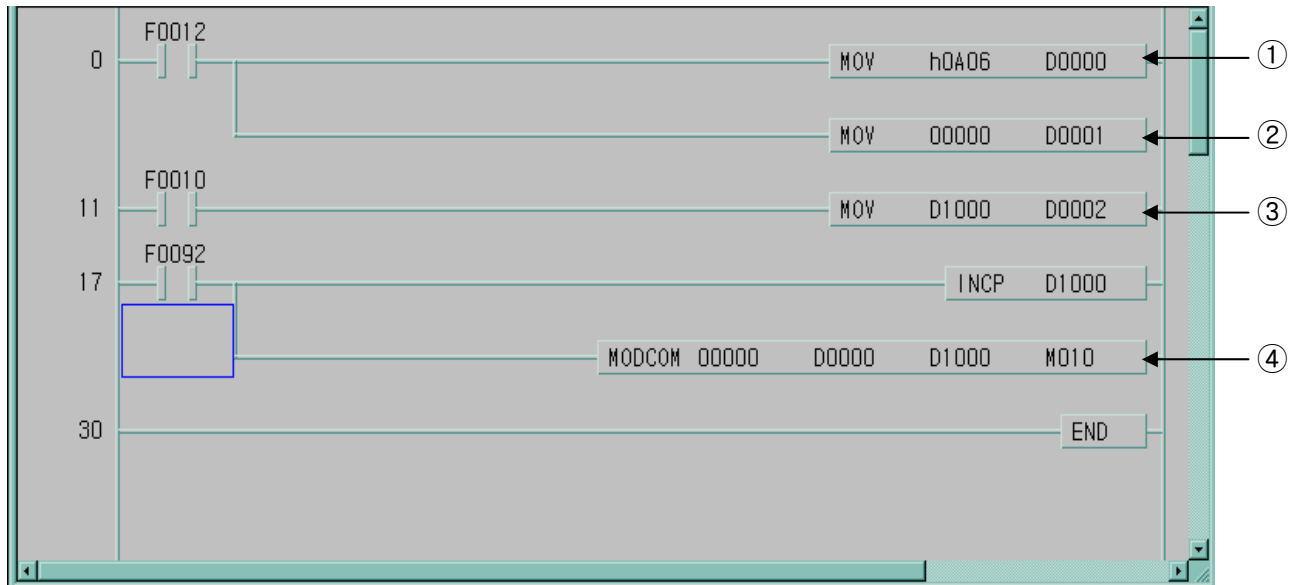

- ① It designates slave station and function code (No. of station: h0A(10) , function code: h06)
- ② Address setting
 - Address '0' of function code '16' at MODBUS protocol actually means address '40000'.
- ③ Save the D1000 data to D0002.
- ④ This is MODBUS Communication instruction.
 - Write the D1000 data via channel 0.

Chapter 9 Maintenance

Be sure to perform daily and periodic maintenance and inspection in order to maintain the PLC option card of iS7 inverter in best conditions.

9.1 Maintenance and Inspection

The I/O module mainly consists of semiconductor devices and its service life is semi-permanent. However, periodic inspection is requested for ambient environment may cause damage to the devices. When inspecting one or two times per six months, check the following items.

Check Items		Judgment	Corrective Actions
Ambient environment	Temperature	0 ~ + 55°C	Adjust the operating temperature and humidity with the defined range.
	Humidity	5 ~ 95%RH	
	Vibration	No vibration	Use vibration resisting rubber or the vibration prevention method.
Play of modules		No play allowed	Securely engage the hook.
Connecting conditions of terminal screws		No loose allowed	Retighten terminal screws.
Change rate of input voltage		- 15% to 10%	Hold it with the allowable range.
Spare parts		Check the number of Spare parts and their Store conditions	Cover the shortage and improve the conditions

9.2 Daily Inspection

The following table shows the inspection and items which are to be checked daily.

Check Items		Check Points	Judgment	Corrective Actions
Connecting conditions of terminal block		check for loose mounting screws	Screws should not be loose	Retighten Screws
		Check the distance between solderless terminals	Proper clearance should be provided	Correct
LED	Run LED	Check that the LED is ON during Run	ON (flickering or Off indicates an error)	-
	ERR LED	Check that the LED is OFF during Run	OFF(ON indicates an error)	-

Chapter 10 Troubleshooting

The following explains contents, diagnosis and corrective actions for various errors that can occur during system operation.

10.1 Basic Procedures of Troubleshooting

System reliability not only depends on reliable equipment but also on short downtimes in the event of faults.

The short discovery and corrective action is needed for speedy operation of the system. The following shows the basic instructions for troubleshooting.

1) Visual checks

Check the following points.

- Machine operating condition (in stop and operating status)
- Power On/Off
 - Status of I/O devices
 - Condition of wiring (I/O wires, extension and communications cables)
 - Display states of various indicators (such as POWER LED, RUN LED, ERR. LED and I/O LED).

After checking them, connect peripheral devices and check the operation status of the PLC option card and the program contents.

2) Trouble Check

Observe any change in the error conditions during the following.

- Switch to the STOP position, and then turn the power on and off.

3) Narrow down the possible causes of the trouble where the fault lies, i.e.:

- Inside or outside of the PLC?
- I/O module or another module?
- PLC option card program?

10.2 Troubleshooting

This section explains the procedure for determining the cause of troubles as well as the errors and corrective actions

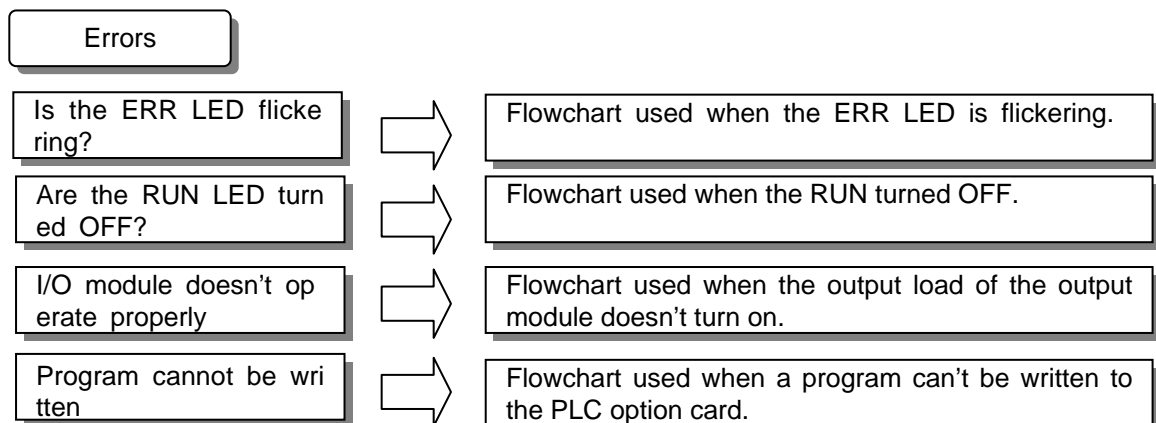

10.2.1 Troubleshooting flowchart used when the ERR LED is flickering

The following flowchart explains corrective action procedure to be used when the ERR LED is flickering during operation.

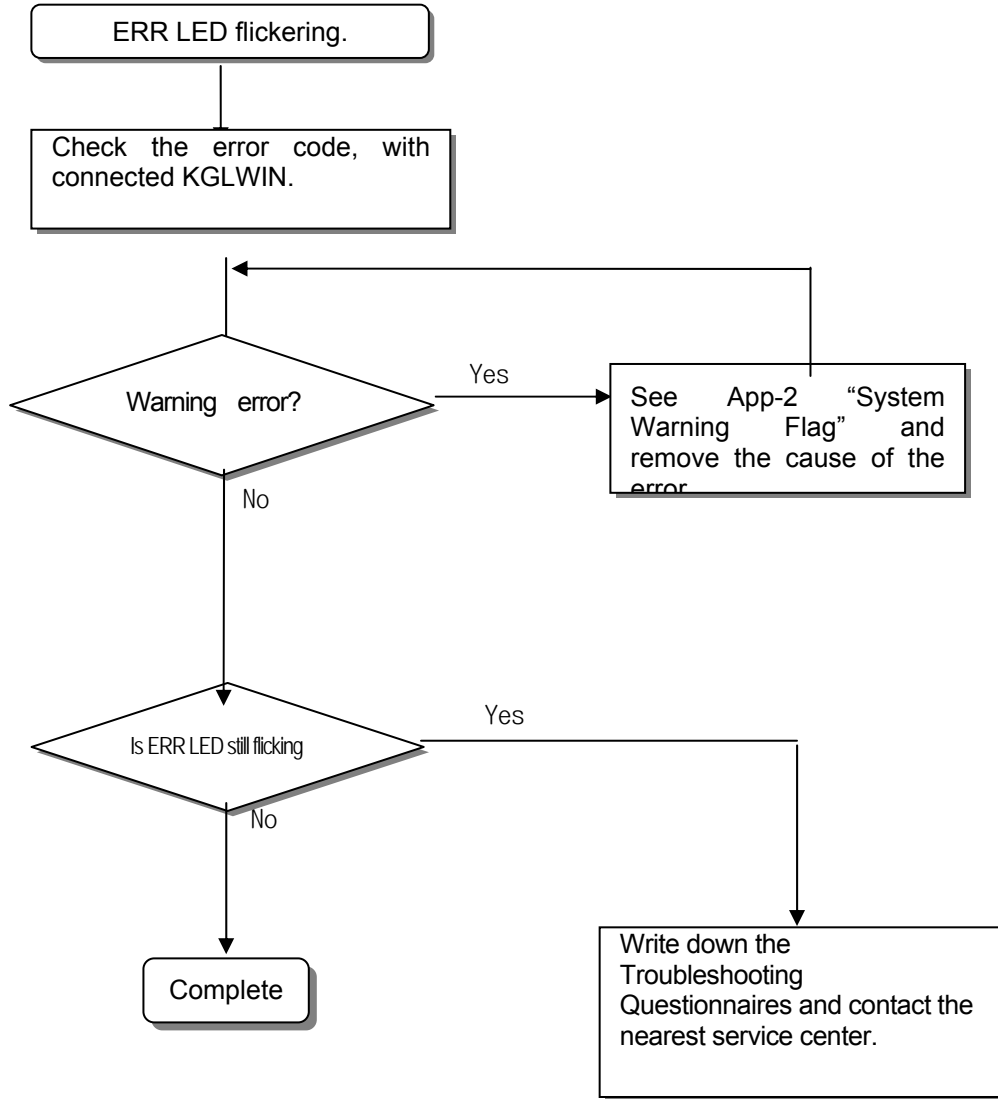

Remark

If warning error appears and PLC option card doesn't stop, corrective action is needed promptly. If not, it may cause the system to fail.

10.2.2 Troubleshooting flowchart used when the RUN LED turns off.

The following flowchart explains corrective action procedure to treat the lights-out of RUN LED when the power is supplied, operation starts or operation is in the process.

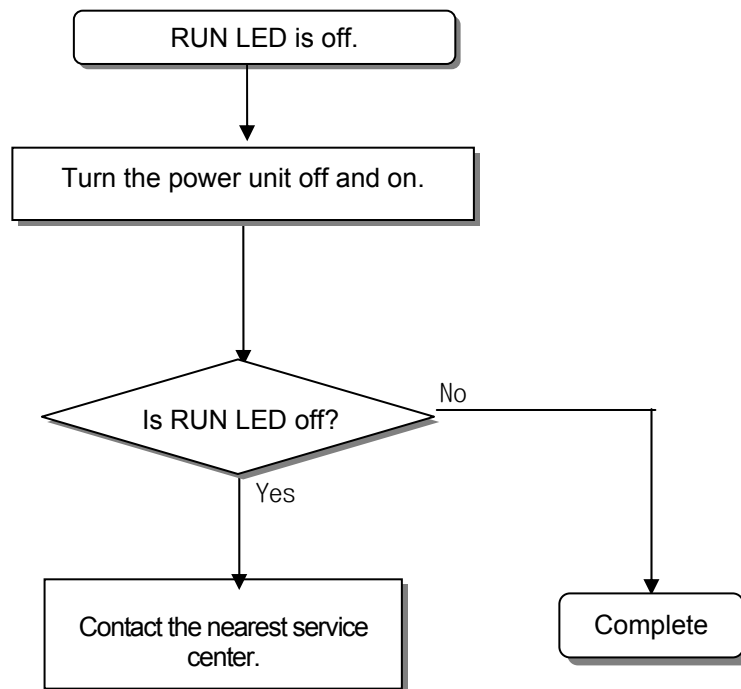

Chapter 10 Troubleshooting

10.2.3 Troubleshooting flowchart used when the I/O part doesn't operate normally.

The following flowchart explains corrective action procedure used when the I/O module doesn't operate normally.

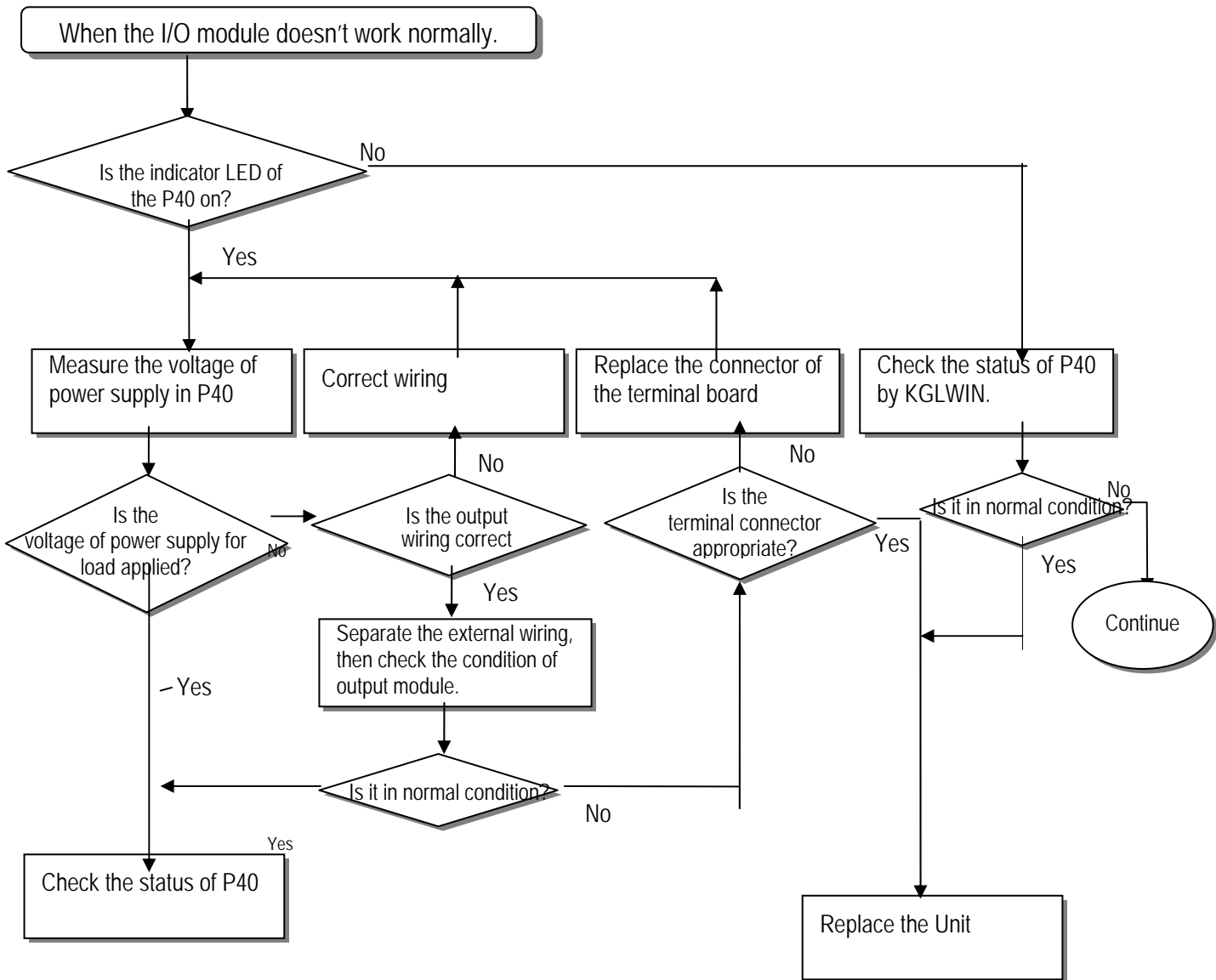
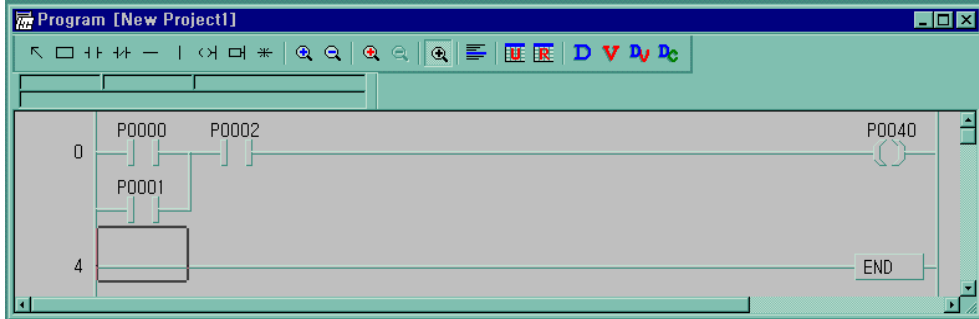

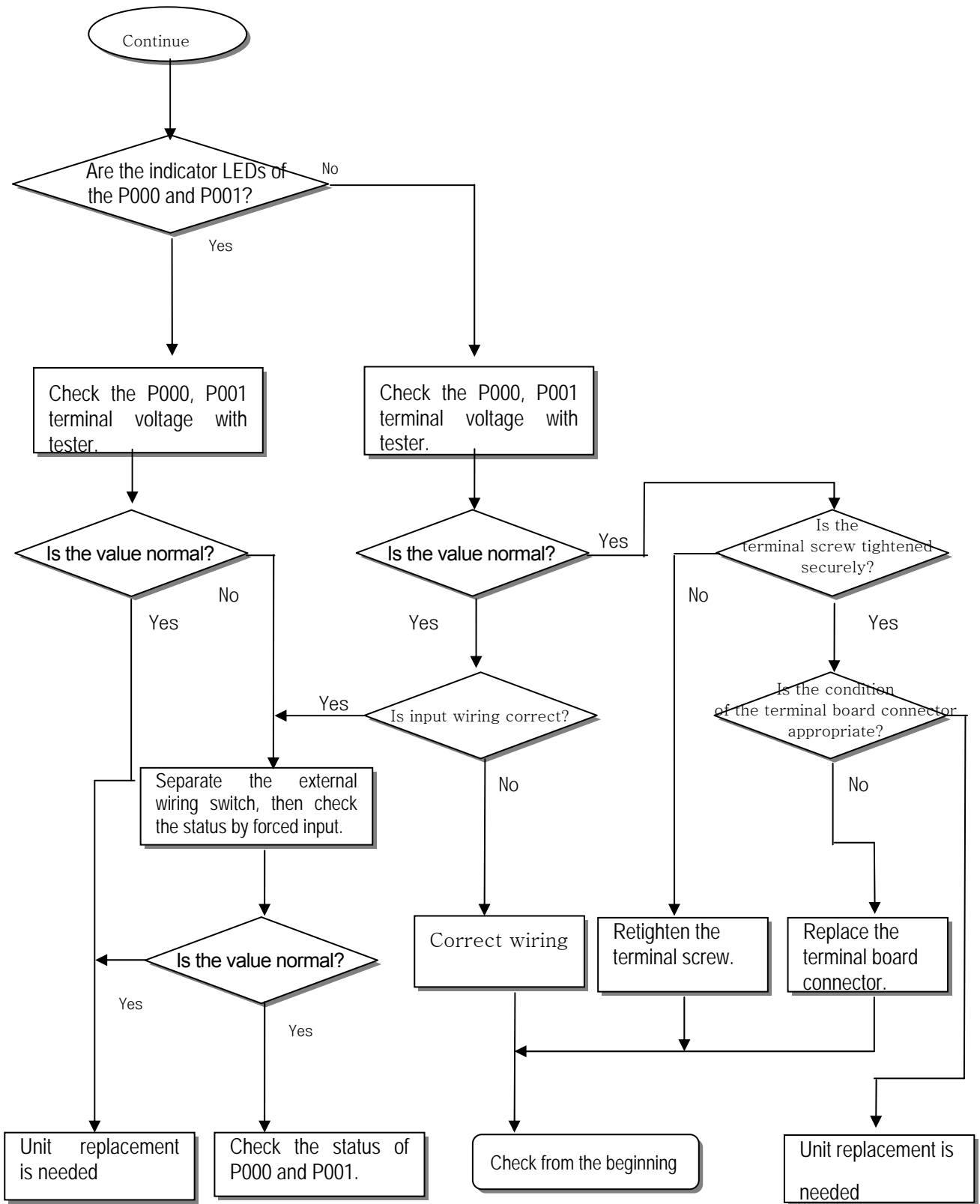

Chapter 10 Troubleshooting

10.2.4 Troubleshooting flowchart used when a program cannot be written to the CPU part

The following flowchart shows the corrective action procedure used when a program cannot be written to the PLC module.

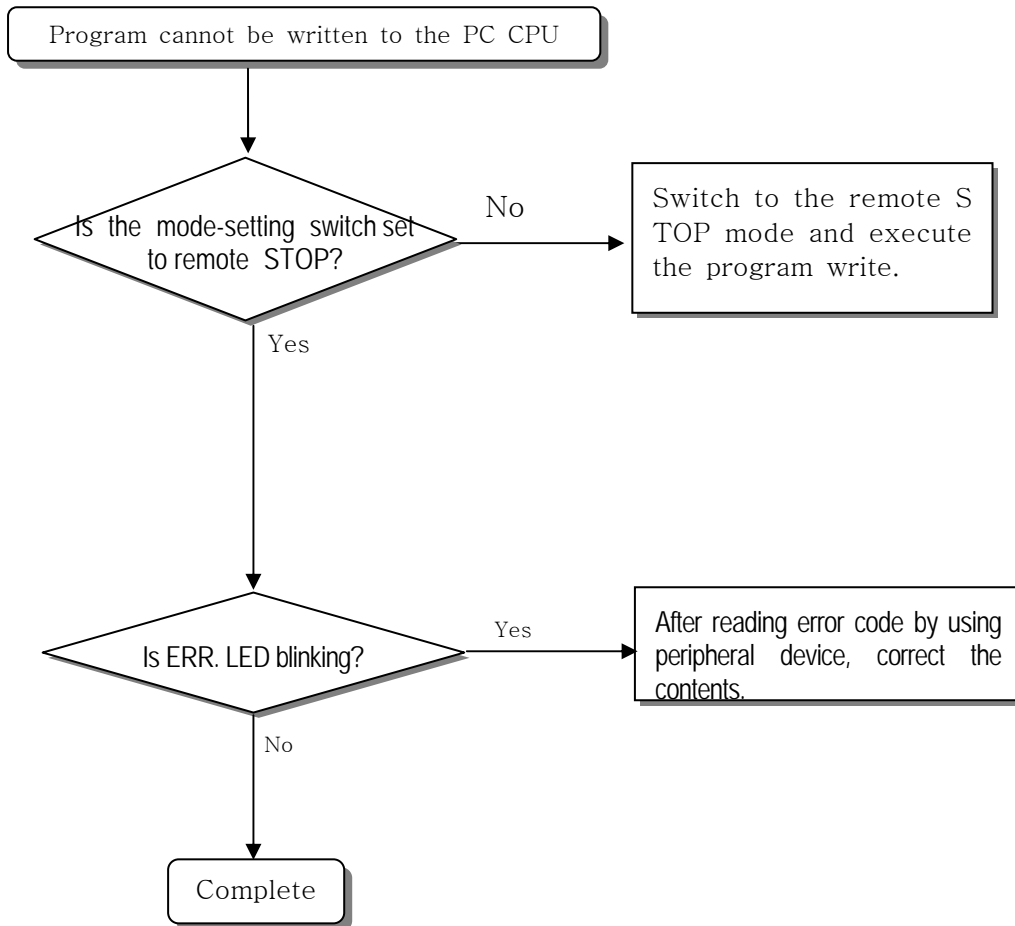

10.3 Troubleshooting Questionnaire

When problems have been met during operation of the PLC Option Card of iS7 inverter series, please write down this Questionnaires and contact the service center via telephone or facsimile.

• For errors related to special or communication modules, use the questionnaire included in the User's manual of the unit.

1. Telephone & FAX No

Tell)

FAX)

2. Using equipment model:

3. Details of using equipment

Option Card model: .() Serial No.()

KGLWIN version No. used to compile programs: ()

4.General description of the device or system used as the control object:

5. The kind of the base unit:

– Operation by the mode setting switch (),

– Operation by the KGLWIN or communications (),

– External memory module operation (),

6. Is the ERR. LED of the CPU module turned ON? Yes(), No()

7. KGLWIN error message:

8. Used initialization program: initialization program ()

9. History of corrective actions for the error message in the article 7:

10. Other tried corrective actions:

11. Characteristics of the error

• Repetitive(): Periodic(), Related to a particular sequence(), Related to environment()

• Sometimes(): General error interval:

12. Detailed Description of error contents:

Chapter 10 Troubleshooting

10.4 Troubleshooting and Countermeasures

Describes the various circuit example and countermeasure.

10.4.1 Input circuit troubles and corrective actions

Describes the various troubleshooting and its countermeasures.

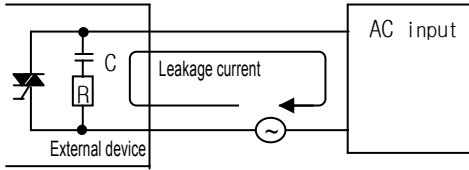
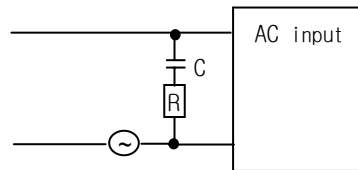
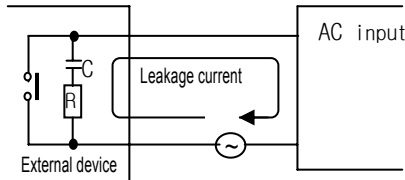
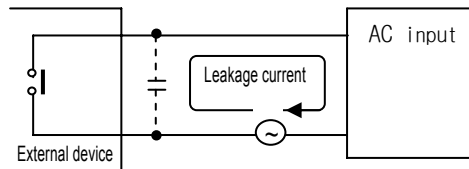
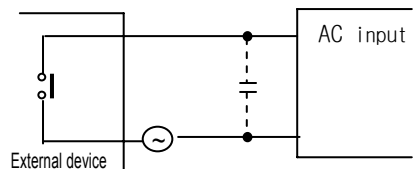
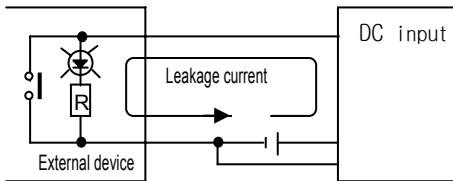
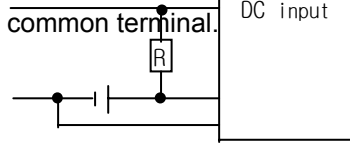
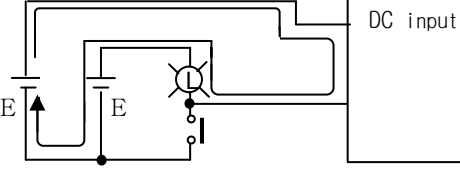
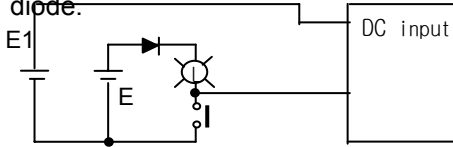
Condition	Cause	Corrective Actions
Input signal doesn't turn off.	Leakage current of external device (Such as a drive by non-contact switch) 	<ul style="list-style-type: none"> Connect an appropriate resistor and capacity, which will make the voltage lower across the terminals of the input module. 
Input signal doesn't turn off. (Neon lamp may be still on)	Leakage current of external device (Drive by a limit switch with neon lamp) 	<ul style="list-style-type: none"> CR values are determined by the leakage current value. – Recommended value C : 0.1 ~ 0.47 μF R: 47 ~ 120 Ω (1/2W) Or make up another independent display circuit.
Input signal doesn't turn off.	Current leakage due to line capacity of wiring cable. 	<ul style="list-style-type: none"> Locate the power supply on the external device side as shown below. 
Input signal doesn't turn off.	Current leakage of external device (Drive by switch with LED indicator) 	<ul style="list-style-type: none"> Connect an appropriate resistor, which will make the voltage higher than the OFF voltage across the input module terminal and common terminal. 
Input signal doesn't turn off.	<ul style="list-style-type: none"> Sneak current due to the use of two different power supplies.  <ul style="list-style-type: none"> E1 > E2, sneaked. 	<ul style="list-style-type: none"> Use only one power supply. Connect a sneak current prevention diode. 

Chapter 10 Troubleshooting

10.4.2 Output circuit troubles and corrective actions

The following describes possible troubles with input circuits, as well as their corrective actions.

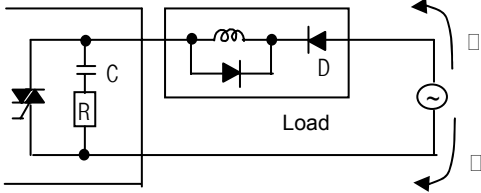
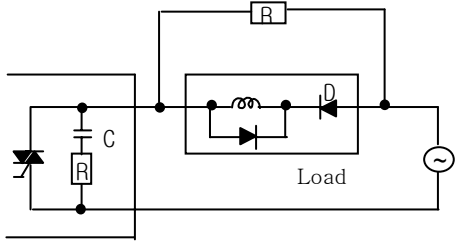
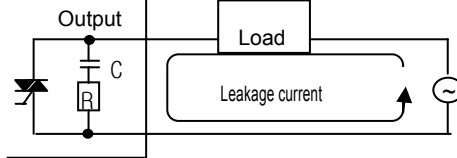
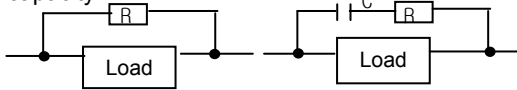
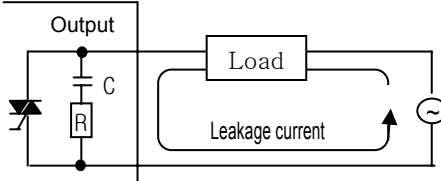
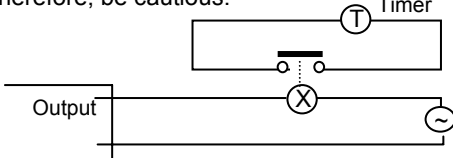
Condition	Cause	Corrective Action
<p>When the output is off, excessive voltage is applied to the load.</p>	<ul style="list-style-type: none"> • Load is half-wave rectified inside (in some cases, it is true of a solenoid) • When the polarity of the power supply is as shown in ①, C is charged. When the polarity is as shown in ②, the voltage charged in C plus the line voltage are applied across D. Max. voltage is approx. $2\sqrt{2}$.  <p>*) If a resistor is used in this way, it does not pose a problem to the output element. But it may make the performance of the diode (D), which is built in the load, drop to cause problems.</p>	<ul style="list-style-type: none"> • Connect resistors of tens to hundreds KΩ across the load in parallel. 
<p>The load doesn't turn off.</p>	<ul style="list-style-type: none"> • Current leakage by surge absorbing circuit, which is connected to output element in parallel. 	<ul style="list-style-type: none"> • Connect C and R across the load, which are of resistors of tens KΩ. When the wiring distance from the output module to the load is long, there may be a leakage current due to the line capacity. 
<p>When the load is C-R type timer, time constant fluctuates.</p>	<ul style="list-style-type: none"> • Current leakage by surge absorbing circuit, which is connected to output element in parallel. 	<ul style="list-style-type: none"> • Drive the relay using a contact and drive the C-R type timer using the since contact. • Use other timer than the C-R contact some timers have half-wave rectified internal circuits therefore, be cautious. 

Chapter 10 Troubleshooting

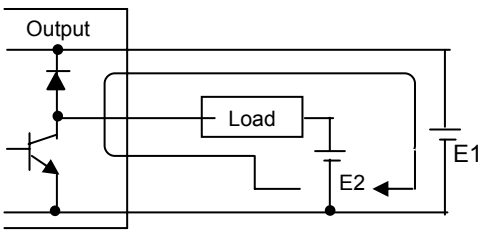
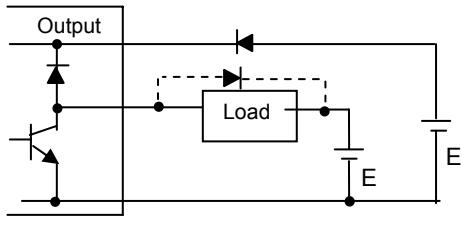
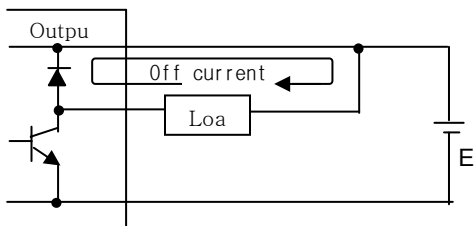
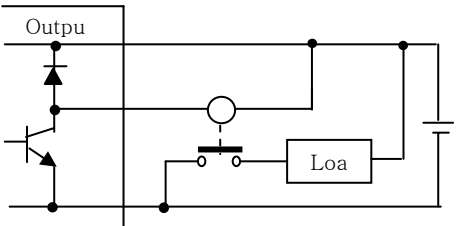
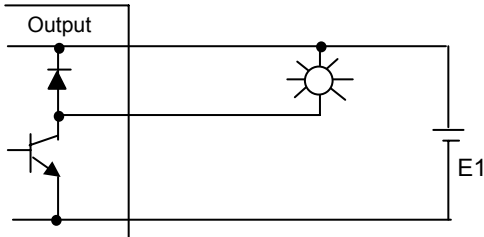
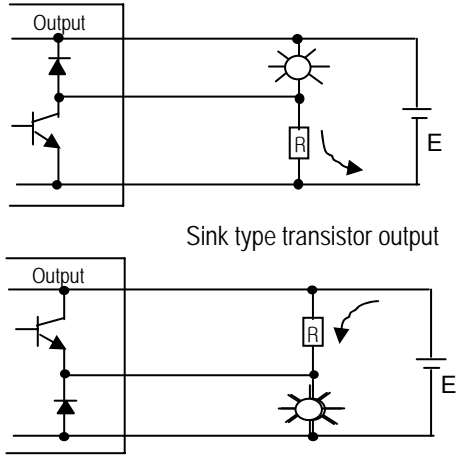
Condition	Cause	Corrective Action
<p>The load does not turn off.</p>	<ul style="list-style-type: none"> Sneak current due to the use of two different power supplies.  <p>$E1 < E2$, sneaks. E1 is off (E2 is on), sneaks.</p>	<ul style="list-style-type: none"> Use only one power supply. Connect a sneak current prevention diode.  <p>If the load is the relay, etc, connect a counter-electromotive voltage absorbing code as shown by the dot line.</p>
<p>The load off response time is long.</p>	<ul style="list-style-type: none"> Over current at off state [The large solenoid current fluidic load (L/R is large) such as is directly driven with the transistor output.  <ul style="list-style-type: none"> The off response time can be delayed by one or more second as some loads make the current flow across the diode at the off time of the transistor output. 	<ul style="list-style-type: none"> Insert a small L/R magnetic contact and drive the load using the same contact. 
<p>Output transistor is destroyed.</p>	<p>Surge current of the white lamp</p>  <p>A surge current of 10 times or more when turned on.</p>	<ul style="list-style-type: none"> To suppress the surge current, make the dark current of 1/3 to 1/5 rated current flow.  <p>Sink type transistor output</p> <p>Source type transistor output</p>

Chapter 10 Troubleshooting

10.5 Error Code List

Error Type	Message	Code (F006)	CPU State	Cause	Corrective Actions
Internal system error	System Error	h0001	Stop	Fault of some area of operating ROM, or H/W defect	Contact the service center.
OS ROM error	OS ROM Error	h0002	Stop	Internal system ROM is defected	Contact the service center.
OS RAM error	OS RAM Error	h0003	Stop	Internal system RAM is defected	Contact the service center.
Data RAM error	DATA RAM Error	h0004	Stop	Data RAM is defected	Contact the service center.
Program RAM error	PGM RAM Error	h0005	Stop	Program RAM is defected	Contact the service center.
Gate array error	G/A Error	h0006	Stop	Defect of dedicated LSI for sequence instruction processing	Contact the service center.
OS WDT error	OS WDT error	h0008	Stop	CPU OS watch dog error	Turn the power off and restart the system. Contact the service center
Common RAM error	Common RAM Error	h0009	Stop	Common RAM interface error	Contact the service center.
Instruction code error	OP Code Error	h000B	Stop	Instructions unreadable by the CPU are included. (during execution)	Contact the service center.
Flash memory error(during execution)	User Memory Error	h000C	Stop	Read to/Write from the inserted Flash memory is not performed.	Check and replace the flash memory.
Parameter Error	Parameter Error	h0020	Stop	A written parameter has changed, or checksum error	Correct the content of the parameter.
Operation Error	Operation Error	h0030	Stop (Continue)	<ul style="list-style-type: none"> • A digit of other than 0 to 9 has met during BCD conversion. • An operand value is outside the defined operand range. 	Correct the content of the error step.
WDT Over	WDT Over	h0031	Stop	Scan time has overrun the watch dog time.	Check the maximum scan time of the program and modify the program or insert programs.
Error of Program Change during run.	PGM Change Error	h0032	Stop	An error has occurred at program change during run.	Program replacement has not been completed during run.
Program Check Error	PGM Change Error	h0033	Continue	An error has occurred while checking a program.	Correct the error.
Code Check Error	Code Check Error	h0040	Stop	An instruction unreadable by the CPU is included.	Correct the error step.
Missing the END instruction in the program	Miss END Error	h0041	Stop	The program does not have the END instruction.	Insert the END instruction at the bottom of the program.
Missing the RET instruction in the program.	Miss RET Error	h0042	Stop	The subroutine does not has the RET instruction at its bottom.	Insert the RET instruction.

Chapter 10 Troubleshooting

Error Type	Message	Code (F006)	CPU State	Cause	Corrective Actions
Missing the SBRT instruction in the subroutine program.	Miss SBRT Error	h0043	Stop	The subroutine does not has the SBRT instruction.	Insert the SBRT instruction.
The JMP ~ JME instruction error	JMP(E) Error	h0044	Stop	The JMP ~ JME instruction error	Correct the JMP ~ JME instruction.
The FOR ~ NEXT instruction error	FOR~NEXT Error	h0045	Stop	The FOR ~ NEXT instruction error	Correct the FOR ~ NEXT instruction.
The MCS ~ MCSCLR instruction error	MCS~MCSCLR Error	h0046	Stop	The MCS ~ MCSCLR instruction error	Correct the MCS ~ MCSCLR instruction.
The MPUSH ~ MPOP instruction error	MPUSH ~ MPOP Error	h0047	Stop	The MPUSH ~ MPOP instruction error	Correct the MPUSH ~ MPOP instruction
Dual coil error	DUAL COIL Error	h0048	Stop	Timer or counter has been duplicated.	Correct timer, counter.
Syntax error	Syntax Error	h0049	Stop	Input condition error, or too much use of LOAD or AND(OR) LOAD.	Check and correct the program.

Appendix 1 System Definitions

(1) Connect Option

You should set the communication port (COM1 ~ 4) to communicate with PLC option card.

- Select the **Project-Option-Connection Option** in menu.
- Default Connection is RS-232C interface.
- For detailed information about **Connection Option**, refer to KGLWIN Manual.

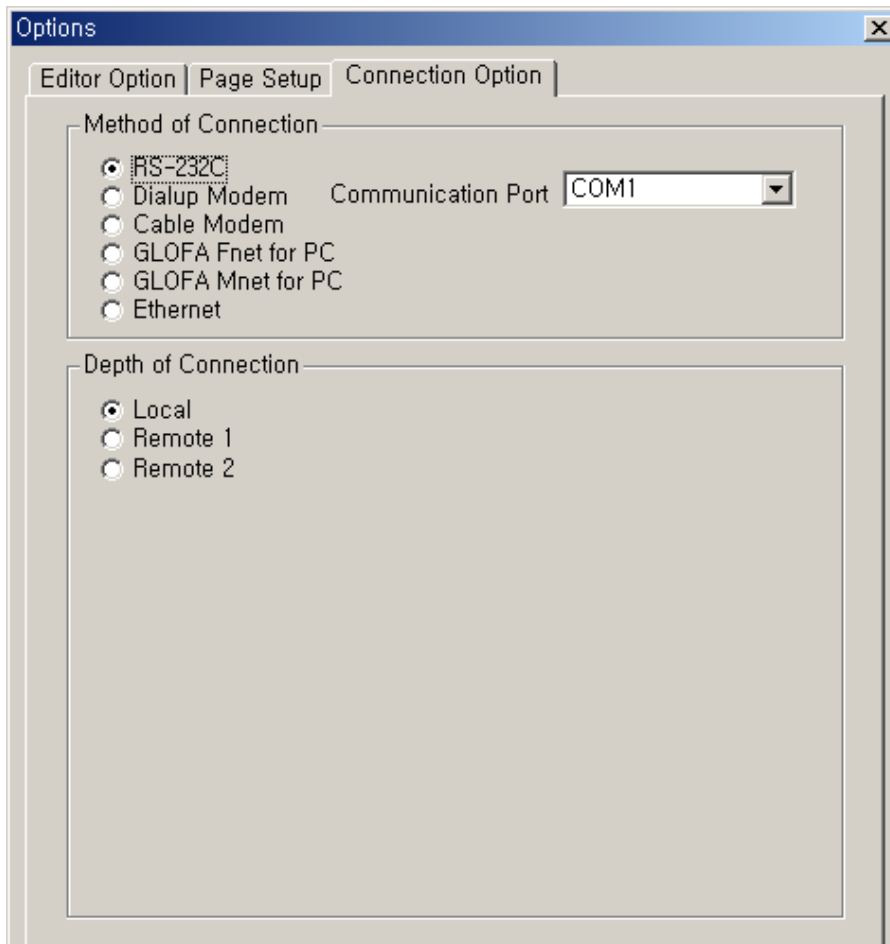

Appendix 1 System Definitions

(2) Editor Option

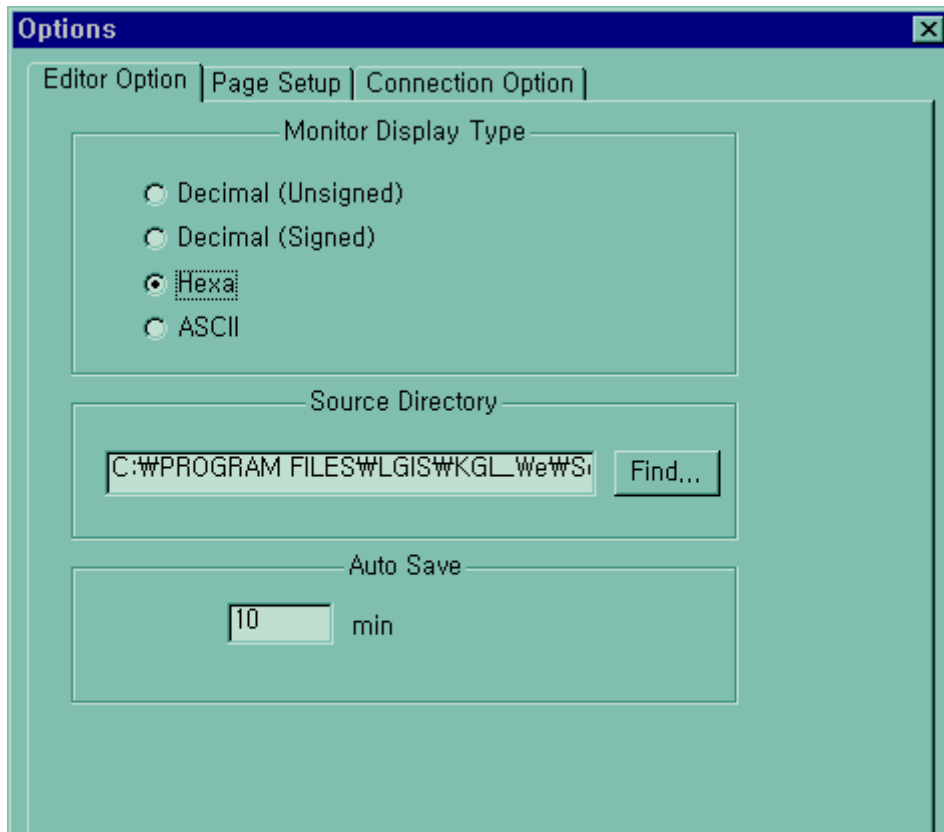

- This function is to set the time interval for Auto saving (Range : 0 ~60 min)
- Automatically saved file is saved in the current directory.
- The file is automatically deleted when the program window is closed. Therefore, if a program cannot be saved by "Program Error" before program is not saved, you can recover some program by loading auto saved file.
- This function is to set the time interval for Auto saving.
- When set to 0, auto save function is disabled.

Appendix 1 System Definitions

(3) Page Setup

You can select print option when printing out the project. (margin, cover, footer)

Options

Editor Option | **Page Setup** | Connection Option

Margin

Top 5 mm
Bottom 0 mm
Left 5 mm
Right 10 mm

Cover

Title
 Company
 Author
 Date
 Description

Footer

Footer LG Industrial systems Co.
 Company
 Author
 Date
 Page

Appendix 1 System Definitions

2) Basic Parameters

The basic parameters are necessary for the operation of the PLC option card.

Set the 'Latch area', 'Timer boundary', 'Watchdog timer', 'PLC operation mode', 'Input setting', 'Pulse catch'

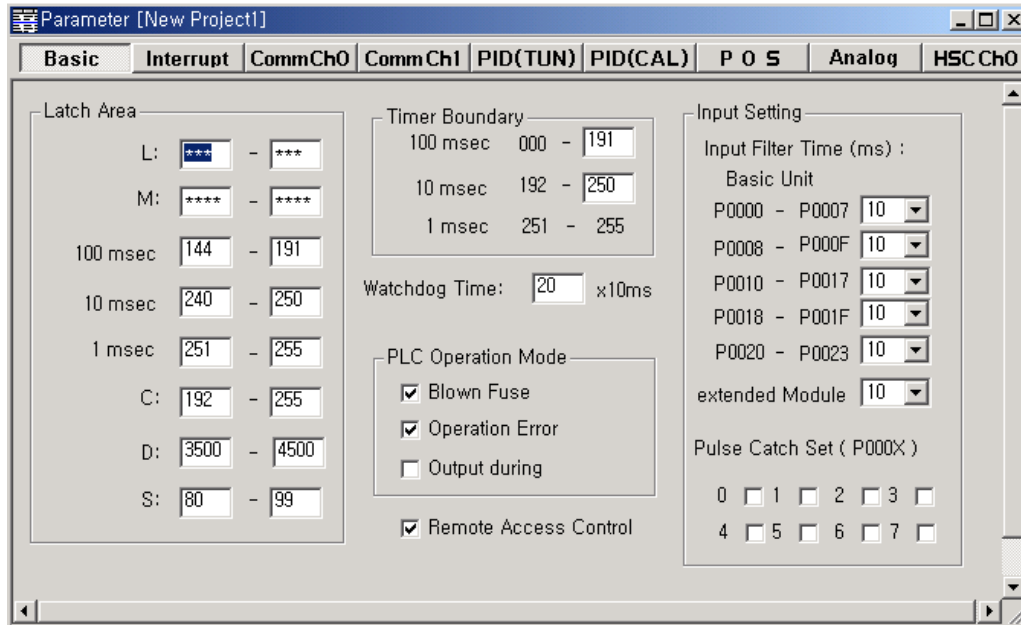

(1) Latch area setting

Set the retain area on the inner device.

(2) Timer boundary setting

Set the 100ms/10ms/1ms timer boundary.

(If 100ms and 10ms timer are set, the rest of timer area is allocated 1ms automatically)

(3) Watchdog timer setting

For the purpose of the watch of normal program execution,.

This parameter is used to set the maximum allowable execution time of a user program in order to supervise its normal or abnormal operation. (Setting range is 10ms ~ 6000ms)

(4) Input setting

Set the input filter constant and input catch contact point

Appendix 2 Flag List

Appendix 2 Flag List

1) Special Relay F Area

Relay	Function	Description
F0000	RUN mode	Turns on when the CPU in the RUN mode.
F0001	Program mode	Turns on when the CPU in the Program mode
F0002	Pause mode	Turns on when the CPU in the Pause mode
F0006	Remote mode	Turns on when the CPU in the Remote mode
F0007	-	-
F0008 ~ F0009	-	-
F000B ~ F000E	-	-
F000F	Execution of the STOP instruction	Turns on when the STOP instruction is being operated.
F0010	Always On	Always On
F0011	Always Off	Always Off
F0012	1 Scan On	1 Scan On
F0013	1 Scan Off	1 Scan Off
F0014	Every Scan toggle	Every Scan toggle
F0015 ~ F001F	-	-
F0025 ~ F002F	-	-
F0030	Fatal Error	Turns on when a fatal error has occurred.
F0031	Warning Error	Turns on when an ordinary error has occurred.
F0032	WDT Error	Turns on when a watch dog timer error has occurred.
F0033	I/O combination error	Turns on when an I/O error has occurred. (When one or more bit(s) of F0040 to F005F turns on)
F0034	Abnormal Battery Voltage Error	Turns on when a battery voltage is lower than set level.
F0035 ~ F0038	-	-
F0039	Normal operation backup	Turns on when the data backup is normal.
F003A	RTC data error	Turns on when the RTC data setting error has occurred.
F003B	Program editing	Turns on during program edit while running the program.
F003C	Program edit error	Turns on when a program edit error has occurred while running the program.

Appendix 2 Flag List

(Continue to Special Relay F Area)

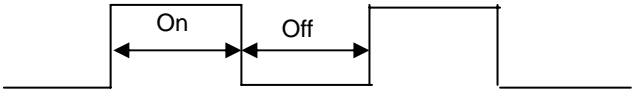
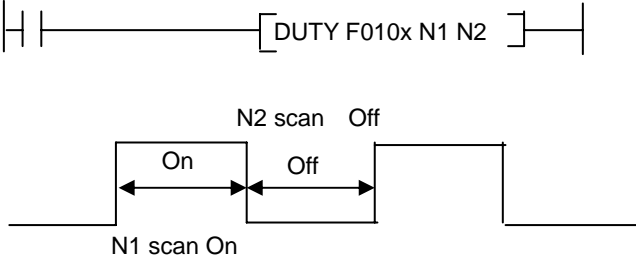
Relay	Function	Description
F003D ~ F003F	-	-
F0040 ~ F005F	I/O error	I/O module has been mounted or dismantled, the corresponding bit turns on.
F0060 ~ F006F	Storing error code	Stores the system error code
F0090	20-ms cycle clock	Turning On/Off is repeated with a constant cycle. 
F0091	100-ms cycle clock	
F0092	200-ms cycle clock	
F0093	1-sec cycle clock	
F0094	2-sec cycle clock	
F0095	10-sec cycle clock	
F0096	20-sec cycle clock	
F0097	60-sec cycle clock	
F0098 ~ F009F	-	-
F0100	User Clock 0	Turning On/Off is repeated as many times as the scan specified by Duty instruction. 
F0101	User Clock 1	
F0102	User Clock 2	
F0103	User Clock 3	
F0104	User Clock 4	
F0105	User Clock 5	
F0106	User Clock 6	
F0107	User Clock 7	
F0108 ~ F010F	-	-
F0110	Operation error flag	Turns on when an operation error has occurred.
F0111	Zero flag	Turns on when the operation result is "0".
F0112	Carry flag	Turns on when a carry occurs due to the operation.
F0113	All outputs off	Turns on when an output instruction is executed.
F0115	Operation error flag (Latch)	Turns on when an operation error has occurred.(Latch)
F0116 ~ F011F	-	-
F0120	LT flag	Turns on if $S_1 < S_2$ when using the CMP instruction.
F0121	LTE flag	Turns on if $S_1 \leq S_2$ when using the CMP instruction.
F0122	EQU flag	Turns on if $S_1 = S_2$ when using the CMP instruction.
F0123	GT flag	Turns on if $S_1 > S_2$ when using the CMP instruction.
F0124	GTE flag	Turns on if $S_1 \geq S_2$ when using the CMP instruction.
F0125	NEQ flag	Turns on if $S_1 \neq S_2$ when using the CMP instruction.

Appendix 2 Flag List

(Continue to Special Relay F Area)

Relay	Function	Description
F0126 ~ F013F	-	-
F0140 ~ F014F	FALS number	The error code generated by FALS instruction is stored to this flag.
F150 ~ F16F	-	-
F170 ~ F173	-	-
F180 ~ F183	-	-
F190 ~ F193	-	-
F0200~ F020F	-	-
F0210~ F021F	-	-
F0220~ F022F	-	-
F0230~ F023F	-	-
F0240~ F024F	-	-
F250 ~ F49F	-	-
F0500~ F050F	Maximum scan time	Stores the maximum scan time.
F0510~ F051F	Minimum scan time	Stores the minimum scan time.
F0520~ F052F	Present scan time	Stores the present scan time.
F0530~ F053F	Clock data (year/month)	Clock data (when RTC option module is installed.)
F0540~ F054F	Clock data (day/hour)	Clock data (when RTC option module is installed.)
F0550~ F055F	Clock data (minute/second)	Clock data (when RTC option module is installed.)
F0560~ F056F	Clock data (hundred year/day of the week)	Clock data (when RTC option module is installed.)
F0570~ F058F	-	-
F0590~ F059F	Storing error step	Stores the error step of the program.
F0600~ F063F	-	-

Appendix 2 Flag List

2) Internal Memory M area

Relay	Function	Description
M1910	Forced I/O Setting Bit	Enables forced I/O.

3) Data Relay D area

(1) D register for Forced I/O setting

I/O	Forced I/O designation register	Forced I/O data register
P000	D4700	D4800
P004	D4704	D4804

(2) System error history (when RTC module is attached)

Relay	Description
D4900	Error pointer
D4901	Year, Month
D4902	Day, Time
D4903	Minute, Second
D4904	Error code

Stop time can be registered maximum 16. If 17th stop is occurred, first stored stop data will be erased and then 17th stop data is inputted.

Relay	Error Pointer
D4901 ~ D4904	First System Stop
D4905 ~ D4908	Second System Stop
~	~
D4961 ~ D4964	16 th system Stop

Appendix 3 Control and Monitoring Specific Inverter Data

Appendix 3 Control and Monitoring Specific Inverter Data

With the method described in “7.2 Exclusive iS7 Inverter Functions of PLC Option Card (page 7-10 ~ 7-24)” of this User Manual, enter the address of the data for control or monitoring (AP065~69) in No. 60~69 of the APO group, using the digital loader of the inverter.

In this appendix, another method which enables control or monitoring of the specific data of inverter (control: frequency and operation reference, monitoring: output frequency and operation status monitoring) without setting up No. 60~69 of the APO group is described.

3.1 List of the special D register fixed for the control/monitoring of inverter

Function	Area	Description	Page to Refer
Control	D4450	Provide inverter with references (STOP, FWD, REV, Fault Reset, emergency stop).	Refer to Appendix 3-3
	D4451	Provide inverter with operation frequency reference.	Refer to Appendix 3-2
Monitoring	D4470	Monitor the present status of the inverter (forward/reverse operation, constant speed, decelerating, stopped, etc.)	Refer to Appendix 3-4
	D4471	Monitor the present output frequency of the inverter.	Refer to Appendix 3-6

Appendix 3 Control and Monitoring Specific Inverter Data

3.2 Control (PLC Option → Inverter)

(1) iS7 Inverter Frequency Reference

▶ Special D register of PLC option card for inverter frequency reference

Special D Register	Use of parameter	Detailed Description
D4451	Inverter Frequency Command	Inverter Frequency Command x 100 (For example, To command inverter frequency 30 Hz command, write 3000 in D4451.)

▶ Exemplary program

1) Set up inverter parameters as follows.

Code	Function Name	Set Value	Remark
DRV07	Freq Ref Src	PLC	-

2) Make out a ladder program as shown below. When the M0000 contact point is ON, the special D register is written with 4000, and thus, the inverter is set up with the reference frequency 40.00Hz.



Caution

If any one of APO60~64(PLC Wr Data1~5) is set up with the “0380Hex” which is the address of the common area of the iS7 inverter frequency reference, it is not possible to provide the inverter with frequency reference via the D4451 special register.

To provide the inverter with frequency reference via the D4451 special register, find out the parameter which is set up with the “0380Hex” which is the address of the common area of the frequency reference of the iS7 inverter and replace the setting with “0000Hex.”

Appendix 3 Control and Monitoring Specific Inverter Data

(2) iS7 Inverter Operation Reference

► Special D register of PLC option card for inverter operation reference

Special D Register	Use of parameter	Detailed Description	
D4470	Inverter Operation Command	BIT0	0: Stop Command 1: Run Command
		BIT1	0: Reverse Operation 1: Forward Operation
		BIT2	0→1 : Fault Reset
		BIT3	0→1 : Free-run to stop 1→0: Fault Reset of Free-run to stop

► Exemplary program

1) Set up inverter parameter as follows.

Code	Function Name	Set Value
DRV01	Cmd Frequency	10.00 Hz
DRV06	Cmd Source	PLC
DRV07	Freq Ref Src	Keypad-1

2) Run the KGLWIN and make out a ladder program as follows. When the M0001 contact is ON, the special D register is written with “1.” Consequently, the inverter is operated in reverse direction (see “List of PLC Special D Registers for Inverter Operation Reference” above).

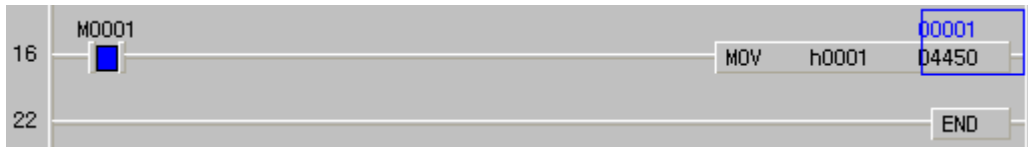

⚠ Caution

If any one of APO60~64(PLC Wr Data1~5) is set up with the “0382Hex” which is the address of the common area of the iS7 inverter operation reference, it is not possible to provide the inverter with operation reference via the D4450 special register.

To provide the inverter with operation reference via the D4450 special register, find out the parameter which is set up with the “0382Hex” which is the address of the common area of the operation reference of the iS7 inverter and replace the setting with “0000Hex.”

Appendix 3 Control and Monitoring Specific Inverter Data

3.3 Monitoring (Inverter → PLC Option)

(1) Operation Status Monitoring of iS7 Inverter

► Special D register of PLC option card for inverter operation status monitoring

Special D Register	Function	Detailed Description	
D4470	Inverter Operation Status	BIT0	0: Stop 1: Forward operation 2: Reverse operation 3: DC operation (or 0 speed control)
		BIT1	
		BIT2	
		BIT3	
		BIT4	1: During speed searching 2: Accelerating 3: Constant speed 4: Decelerating 5: Deceleration to stop 6: During H/W OC restraint 7: During S/W OC restraint 8: Dwell operating
		BIT5	
		BIT6	
		BIT7	
		BIT8	Reserved
		BIT9	
		BIT10	
		BIT11	
		BIT8	0: Normal Status 4: Warning Status 8: Fault Status
		BIT9	
		BIT10	
BIT11			

► Exemplary program

1) Set up iS7 inverter parameters as follows.

Code	Function Name	Set Value
DRV01	Cmd Frequency	12.00 Hz
DRV06	Cmd Source	Keypad
DRV07	Freq Ref Src	Keypad-1

2) Run the KGLWIN and make out following program.

0	=	D4470	h0000	—	P0050	Stopped
6	=	D4470	h0021	—	P0051	Forward Accel.
12	=	D4470	h0031	—	P0052	Forward Constant Speed.
18	=	D4470	h0041	—	P0053	Forward Decel.

Appendix 3 Control and Monitoring Specific Inverter Data

3) In stop condition, D4470 is "h0000" (see "List of PLC option card Special D Registers for Inverter Operation Status Monitoring" above).

0	=	00000	D4470	h0000		P0050	정지상태
6	=	00000	D4470	h0021		P0051	정방향 가속
12	=	00000	D4470	h0031		P0052	정방향 정속
18	=	00000	D4470	h0041		P0053	정방향 감속

4) Now, press the "FWAD" key on the digital loader of the inverter to give forward operation reference. During forward acceleration, D4470 is "h0021" (see "List of PLC option card Special D Registers for Inverter Operation Status Monitoring" above).

0	=	00033	D4470	h0000		P0050	Stopped
6	=	00033	D4470	h0021		P0051	Forward Accel.
12	=	00033	D4470	h0031		P0052	Forward Constant Speed.
18	=	00033	D4470	h0041		P0053	Forward Decel.

5) While in constant speed in forward operation, D4470 is "h0031" (see "List of PLC option card Special D Registers for Inverter Operation Status Monitoring" above).

0	=	00049	D4470	h0000		P0050	Stopped
6	=	00049	D4470	h0021		P0051	Forward Accel.
12	=	00049	D4470	h0031		P0052	Forward Constant Speed.
18	=	00049	D4470	h0041		P0053	Forward Decel.

6) On the digital loader of the inverter, change DRV01 (Cmd Frequency) into "5.00 Hz" for forward deceleration. In this mode, D4470 is "h0041" (see "List of PLC option card Special D Registers for Inverter Operation Status Monitoring" above).

0	=	00065	D4470	h0000		P0050	Stopped
6	=	00065	D4470	h0021		P0051	Forward Accel.
12	=	00065	D4470	h0031		P0052	Forward Constant Speed.
18	=	00065	D4470	h0041		P0053	Forward Decel.

Appendix 3 Control and Monitoring Specific Inverter Data

(2) iS7 Inverter Output Frequency Monitoring

- Special D register of PLC option card for inverter output frequency monitoring

Special D Register	Function	Detailed Description
D4471	Output Freq.	Current output Freq. x 100 (Ex. If D4471 value is 3125, current output freq. is 31.25 Hz.)

- Exemplary program

- 1) Set up iS7 inverter parameters as follows.

Code	Function Name	Set Value
DRV01	Cmd Frequency	29.00 Hz
DRV06	Cmd Source	Keypad
DRV07	Freq Ref Src	Keypad-1

- 2) Run the KGLWIN and make out following program.



- 3) On the inverter's digital loader, press "FWD" for forward operation to 29.00Hz.

- 4) Now, the D4471 will read "2900" as shown below.

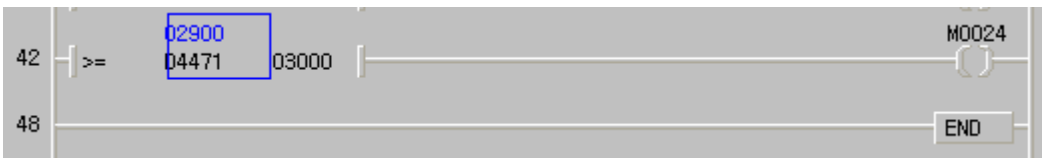

- 5) Set up DRV01 (Cmd Frequency) to "30.00Hz." The D4471 will be changed to "03000" and the M0024 relay will be ON.



Appendix 4 Common Area Parameter of iS7 Inverter

4.1 Common Area Parameter (for Monitoring)

Address	Parameter	Scale	Unit	R/W	Detailed Description
0x0300	Inverter Model	-	-	R	iS7 : 000Bh
0x0301	inverter capacity	-	-	R	0.75kW: 3200h 1.5kW: 4010h 3.7kW: 4037h 7.5kW: 4075h 15kW: 40F0h 22kW: 4160h 37kW: 4250h 55kW: 4370h 110kW: 46E0h 220kW: 4DC0h 375kW: 5770h 2.2kW: 4022h 5.5kW: 4055h 11kW: 40B0h 18.5kW: 4125h 30kW: 41E0h 45kW: 42D0h 75kW: 44B0h 160kW: 4A00h 315kW: 53B0h
0x0302	Inverter input voltage / power supply type (single phase, 3 phase) / cooling method	-	-	R	200V single phase open air cooling : 0220h 200V 3 phase open air cooling : 0230h 200V single phase forced cooling : 0221h 200V 3 phase forced cooling : 0231h 400V single phase open air cooling : 0420h 400V 3 phase open air cooling : 0430h 400V single phase forced cooling : 0421h 400V 3 phase forced cooling : 0431h
0x0303	inverter S/W version	-	-	R	Ex) Ver1.02 : 0102h
0x0304	Reserved	-	-	-	-
0x0305	Inverter operating status	-	-	R	BIT15 0 : normal status BIT14 4 : Warning status BIT13 8 : Fault status(operates according to set value of PRT-30 Trip Out Mode) BIT12 BIT11 BIT10 BIT9 BIT8 None BIT7 1:speed search 2:accelerating BIT6 3:steady speed 4:decelerating BIT5 5:decelerating stop 6:H/W OCS BIT4 7:S/W OCS 8:dwel operating BIT3 0 : stop BIT2 1 : forward operating BIT1 2 : reverse operating BIT0 3 : DC operating(0 speed control)
0x0306	inverter operating, frequency command source	-	-	R	BIT15 BIT14 operating command source BIT13 0:keypad BIT12 1:communication option BIT11 2:App/PLC 3:built-in485 BIT10 4:terminal block 5:reserved BIT9 6:Auto 1 7:Auto 2 BIT8 BIT7 - frequency command source BIT6 0:keypad speed 1:keypad torque BIT5 2~4:Up/Down operating speed BIT4 5: V1 6: I1 7: V2 8: I2

Appendix 4 Common Area Parameter of iS7 Inverter

Address	Parameter	Scale	Unit	R/W	Detailed Description	
					BIT3	9: Pulse 10: built-in485 11:communication option 12: App(PLC) 13: Jog 14: PID 15~22 : Auto Step 25~39 : sequential frequency
					BIT2	
					BIT1	
					BIT0	
0x0307	keypad S/W version	-	-	R	(Exercise) 0x0100 : Version 1.00	
0x0308	keypad Title version	-	-	R	0x0101 : Version 1.01	
0x0309 ~0x030 F	Reserved	-	-	-	-	
0x0310	output current	0.1	A	R	-	
0x0311	output frequency	0.01	Hz	R	-	
0x0312	output RPM	0	RPM	R	-	
0x0313	motor feedback speed	0	RPM	R	-32768 [RPM] ~ 32767 [RPM] (direction)	
0x0314	output voltage	0.1	V	R	-	
0x0315	DC Link voltage	0.1	V	R	-	
0x0316	output power	0.1	kW	R	-	
0x0317	output Torque	0.1	%	R	-	
0x0318	PID reference	0.1	%	R	-	
0x0319	PID feedback	0.1	%	R	-	
0x031A	Show poles of first motor	-	-	R	Show poles of first motor	
0x031B	Show poles of second motor	-	-	R	Show poles of second motor	
0x031C	Show poles of selected motor	-	-	R	Show poles of selected motor	
0x031D	Select Hz/rpm	-	-	R	0 : Hz unit	1 : rpm unit
0x031E ~0x031 F	Reserved	-	-	-	-	
0x0320	Digital Input Information	-	-	R	BIT15	None
					BIT14	None
					BIT13	None
					BIT12	None
					BIT11	None
					BIT10	P11 (Expansion IO Terminal Input 3)
					BIT9	P10 (Expansion IO Terminal Input 2)
					BIT8	P9 (Expansion IO Terminal Input 1)
					BIT7	P8 (Basic IO Terminal Input 8)
					BIT6	P7 (Basic IO Terminal Input 7)
					BIT5	P6 (Basic IO Terminal Input 6)
					BIT4	P5 (Basic IO Terminal Input 5)
					BIT3	P4 (Basic IO Terminal Input 4)
					BIT2	P3 (Basic IO Terminal Input 3)
BIT1	P2 (Basic IO Terminal Input 2))					
BIT0	P1 (Basic IO Terminal Input 1)					
0x0321	Digital Output Information	-	-	R	BIT15	None
					BIT14	None
					BIT13	None
					BIT12	None
					BIT11	None
					BIT10	None
					BIT9	None
					BIT8	None

Appendix 4 Common Area Parameter of iS7 Inverter

Address	Parameter	Scale	Unit	R/W	Detailed Description	
					BIT7	None
					BIT6	None
					BIT5	Q4 (Expansion IO Relay Output 3)
					BIT4	Q3 (Expansion IO Relay Output 2)
					BIT3	Q2 (Expansion IO Relay Output 1)
					BIT2	Q1 (Basic IO TR Output1)
					BIT1	Relay2 (Basic IO Relay Output 2)
					BIT0	Relay1 (Basic IO Relay Output1)
0x0322	Virtual Digital Input Information	-	-	R	BIT15	0: OFF State 1: ON State (COM85:Virtual DI16)
					BIT14	0: OFF State 1: ON State (COM84:Virtual DI15)
					BIT13	0: OFF State 1: ON State (COM83:Virtual DI14)
					BIT12	0: OFF State 1: ON State (COM82:Virtual DI13)
					BIT11	0: OFF State 1: ON State (COM81:Virtual DI12)
					BIT10	0: OFF State 1: ON State (COM80:Virtual DI11)
					BIT9	0: OFF State 1: ON State (COM79:Virtual DI10)
					BIT8	0: OFF State 1: ON State (COM78:Virtual DI9)
					BIT7	0: OFF State 1: ON State (COM77:Virtual DI8)
					BIT6	0: OFF State 1: ON State (COM76:Virtual DI7)
					BIT5	0: OFF State 1: ON State (COM75:Virtual DI6)
					BIT4	0: OFF State 1: ON State (COM74:Virtual DI5)
					BIT3	0: OFF State 1: ON State (COM73:Virtual DI4)
					BIT2	0: OFF State 1: ON State (COM72:Virtual DI3)
					BIT1	0: OFF State 1: ON State (COM71:Virtual DI2)
					BIT0	0: OFF State 1: ON State (COM70:Virtual DI1)
0x0323	Show selected Motor	-	-	R	0: First motor, 1:Second motor	
0x0324	AI1	0.01	%	R	analog input1 (basic I/O)	
0x0325	AI2	0.01	%	R	analog input2 (basic I/O)	
0x0326	AI3	0.01	%	R	analog input3 (extended I/O)	
0x0327	AI4	0.01	%	R	analog input4 (extended I/O)	
0x0328	AO1	0.01	%	R	analog output1 (basic I/O)	
0x0329	AO2	0.01	%	R	analog output2 (basic I/O)	
0x032A	AO3	0.01	%	R	analog output3 (extended I/O)	
0x032B	AO4	0.01	%	R	analog output4 (extended I/O)	
0x032C	Reserved	-	-	-	-	
0x032D	Reserved	-	-	-	-	
0x032E	Reserved	-	-	-	-	
0x032F	Reserved	-	-	-	-	
0x0330	latch type trip information-1	-	-	R	BIT1 5	Fuse Open Trip
					BIT1	Overheat Trip

Appendix 4 Common Area Parameter of iS7 Inverter

Address	Parameter	Scale	Unit	R/W	Detailed Description	
					4	
					BIT1 3	Arm Short
					BIT1 2	External Trip
					BIT11	Overvoltage Trip
					BIT1 0	Overcurrent Trip
					BIT9	NTC Trip
					BIT8	Overspeed Deviation
					BIT7	Overspeed
					BIT6	input open phase trip
					BIT5	output open pahse trip
					BIT4	Ground Fault Trip
					BIT3	E-Thermal Trip
					BIT2	Inverter Overload Trip
					BIT1	Underload Trip
BIT0	Overload Trip					
0x0331	latch type trip information-2	-	-	R	BIT15	None
					BIT14	None
					BIT13	None
					BIT12	Slot3 option board contact failure
					BIT11	Slot2 option board contact failure
					BIT10	Slot1 option board contact failure
					BIT9	No motor trip
					BIT8	External break trip
					BIT7	basic IO board contact failure
					BIT6	Pre PID Fail
					BIT5	Parameter Write error
					BIT4	None
					BIT3	FAN Trip
					BIT2	PTC(Thermal sensor) Trip
BIT1	Encoder Error Trip					
BIT0	MC Fail Trip					
0x0332	Level Type Trip Information	-	-	R	BIT15	None
					BIT14	None
					BIT13	None
					BIT12	None
					BIT11	None
					BIT10	None
					BIT9	None
					BIT8	None
					BIT7	None
					BIT6	None
					BIT5	None
					BIT4	None
					BIT3	Keypad Lost Command
					BIT2	Lost Command
BIT1	LV					
BIT0	BX					
0x0333	H/W Diagnosis Trip Inforamtion	-	-	R	BIT15	None
					BIT14	None
					BIT13	None
					BIT12	None
					BIT11	None
					BIT10	None

Appendix 4 Common Area Parameter of iS7 Inverter

Address	Parameter	Scale	Unit	R/W	Detailed Description	
					BIT9	None
					BIT8	None
					BIT7	None
					BIT6	None
					BIT5	None
					BIT4	Gate Drive Power Loss
					BIT3	Watchdog-2 Error
					BIT2	Watchdog-1 Error
					BIT1	EEPROM Error
					BIT0	ADC Error
0x0334	Warning Information	-	-	R	BIT15	None
					BIT14	None
					BIT13	None
					BIT12	None
					BIT11	None
					BIT10	None
					BIT9	Auto Tunning Failure
					BIT8	Keypad Lost
					BIT7	encoder mis-connected
					BIT6	encoder mis-mounted
					BIT5	DB
					BIT4	FAN Operation
					BIT3	Lost command
					BIT2	Inverter Overload
BIT1	Underload					
BIT0	Overload					
0x0335 ~0x033 F	Reserved	-	-	-	-	
0x0340	On Time Date	-	Day	R	Days when inverter is ON	
0x0341	On Time Minute	-	Min	R	Minutes with total days on time subtracted	
0x0342	Run Time Date	-	Day	R	Total days when the inverter operates the motor	
0x0343	Run Time Minute	-	Min	R	Minutes with total days Run time subtracted	
0x0344	Fan Time Date	-	Day	R	Total days when the fan operates	
0x0345	Fan Time Minute	-	Min	R	Minutes with total days Fan time subtracted	
0x0346 ~0x034 9	Reserved	-	-	-	-	
0x034A	Option 1	-	-	R	0: None 3: Profibus 7: RNet 10: PLC 23: Encoder 1,2: Reserved 4,5,6: Reserved 8,9: Reserved 20: External IO-1	
0x034B	Option 2	-	-	R		
0x034C	Option 3	-	-	R		

Appendix 4 Common Area Parameter of iS7 Inverter

4.2. Inverter Common Area Parameter (Control)

Address	Parameter	Scale	Unit	R/W	Detailed Description	
0x0380	frequency command	0.01	Hz	R/W	Command Frequency Setting	
0x0381	RPM command	1	RPM	R/W	Command RPM Setting	
0x0382	operating command	-	-	R/W	BIT3	Changed from 0 to 1: Free-run to stop
					BIT2	Changed from 0 to 1: Trip Reset
					BIT1	0: Reverse Command 1: Forward Command
					BIT0	0: STOP Command 1: RUN Command
					Ex) Forward run command:0003h, Reverse run command:0001h	
0x0383	accelerating time	0.1	sec	R/W	Acceleration time setting	
0x0384	decelerating time	0.1	sec	R/W	Deceleration time setting	
0x0385	virtual digital input control (0:Off, 1:On)	-	-	R/W	BIT1 5	0: OFF Command 1: ON Command (COM65:Virtual DI16)
					BIT1 4	0: OFF Command 1: ON Command (COM64:Virtual DI15)
					BIT1 3	0: OFF Command 1: ON Command (COM63:Virtual DI14)
					BIT1 2	0: OFF Command 1: ON Command (COM62:Virtual DI13)
					BIT11	0: OFF Command 1: ON Command (COM61:Virtual DI12)
					BIT1 0	0: OFF Command 1: ON Command (COM60:Virtual DI11)
					BIT9	0: OFF Command 1: ON Command (COM59:Virtual DI10)
					BIT8	0: OFF Command 1: ON Command (COM58:Virtual DI9)
					BIT7	0: OFF Command 1: ON Command (COM57:Virtual DI8)
					BIT6	0: OFF Command 1: ON Command (COM56:Virtual DI7)
					BIT5	0: OFF Command 1: ON Command (COM55:Virtual DI6)
					BIT4	0: OFF Command 1: ON Command (COM54:Virtual DI5)
					BIT3	0: OFF Command 1: ON Command (COM53:Virtual DI4)
					BIT2	0: OFF Command 1: ON Command (COM52:Virtual DI3)
					BIT1	0: OFF Command 1: ON Command (COM51:Virtual DI2)
BIT0	0: OFF Command 1: ON Command (COM50:Virtual DI1)					
0x0386	digital output control (0:Off, 1:On)	-	-	R/W	BIT5	0 : OFF Command 1 : ON Command (Expansion IO, OUT36: Q4 Define is "None")
					BIT4	0 : OFF Command 1 : ON Command (Expansion IO, OUT35: Q3 Define is "None")
					BIT3	0 : OFF Command 1 : ON Command (Expansion IO, OUT34: Q2 Define is "None")

Appendix 4 Common Area Parameter of iS7 Inverter

Address	Parameter	Scale	Unit	R/W	Detailed Description
					BIT2 0 : OFF Command 1 : ON Command (Basic IO, OUT33: Q1 Define 0 "None")
					BIT1 0 : OFF Command 1 : ON Command (Basic IO, OUT32: Relay2 is "None")
					BIT0 0 : OFF Command 1 : ON Command (Basic IO, OUT31: Relay1 is "None")
0x0387	Reserved	-	-	-	-
0x0388	PID reference	0.1	%	R/W	PID reference command released
0x0389	PID feedback value	0.1	%	R/W	PID feedback value
0x038A ~0x038 F	Reserved	-	-	-	torque command
0x0390	Torque Ref	0.1	%	R/W	forward motor ring torque limit
0x0391	Fwd Pos Torque Limit	0.1	%	R/W	forward regenerative torque limit
0x0392	Fwd Neg Torque Limit	0.1	%	R/W	reverse motor ring torque limit
0x0393	Rev Pos Torque Limit	0.1	%	R/W	reverse regenerative torque limit
0x0394	Rev Neg Torque Limit	0.1	%	R/W	torque Bias
0x0395	Torque Bias	0.1	%	R/W	PID reference command released
0x0396 ~0x039 9	Reserved	-	-	-	-
0x039A	Anytime Para				CNF-20 of iS7 value setting
0x039B	Monitor Line-1				CNF-21 of iS7 value setting
0x039C	Monitor Line-2				CNF-22 of iS7 value setting
0x039D	Monitor Line-3				CNF-23 of iS7 value setting



**LS values every single customer.
Quality and service come first at LSIS.
Always at your service, standing for our customers.**

www.lsis.biz

LS Industrial Systems

■ **HEAD OFFICE**

LS tower, Hogye-dong, Dongan-gu, Anyang-si,
Gyeonggi-do 1026-6, Korea <http://eng.lsis.biz>
Tel. (82-2)2034-4689, 4888 Fax.(82-2)2034-4648

■ **LS Industrial Systems Tokyo Office >> Japan**

Address: 16F, Higashi-Kan, Akasaka Twin Towers 17- 22,
2-chome, Akasaka, Minato-ku, Tokyo 107-8470, Japan
Tel: 81-3-3582-9128 Fax: 81-3-3582-2667

e-mail: jschuna@lsis.biz

■ **LS Industrial Systems Dubai Rep. Office >> UAE**

Address: P.O.BOX-114216, API World Tower, 303B, Sheikh
Zayed road, Dubai, UAE. e-mail: hwyim@lsis.biz
Tel: 971-4-3328289 Fax: 971-4-3329444

■ **LS-VINA Industrial Systems Co., Ltd. >> Vietnam**

Address: LSIS VINA Congty che tao may dien Viet-Hung
Dong Anh Hanoi, Vietnam e-mail: srjo@hn.vnn.vn
Tel: 84-4-882-0222 Fax: 84-4-882-0220

■ **LS Industrial Systems Hanoi Office >> Vietnam**

Address: Room C21, 5th Floor, Horizon Hotel, 40 Cat Linh,
Hanoi, Vietnam
Tel: 84-4-736-6270/1 Fax: 84-4-736-6269

■ **Dalian LS Industrial Systems co., Ltd. >> China**

Address: No. 15 Liaohexi 3 Road, economic and technical
development zone, Dalian, China e-mail: lxk@lgis.com.cn
Tel: 86-411-8273-7777 Fax: 86-411-8730-7560

■ **LS Industrial Systems (Shanghai) Co., Ltd. >> China**

Address: Room E-G, 12th Floor Huamin Empire Plaza,
No. 726, West Yan'an Road, Shanghai, China
Tel: 86-21-5237-9977

■ **LS Industrial Systems(Wuxi) Co., Ltd. >> China**

Address: 102-A National High & New Tech Industrial
Development Area, Wuxi, Jiangsu, China e-mail: Xugh@lgis.com.cn
Tel: 86-510-534-6666 Fax: 86-510-522-4078

■ **LS Industrial Systems Beijing Office >> China**

Address: B-tower 17th Floor, Beijing Global Trade Center building,
No. 36, BeiSanHuanDong-Lu, DongCheng-District, Beijing, China
Tel: 86-10-5825-6025

■ **LS Industrial Systems Guangzhou Office >> China**

Address: Room 1403, 14F, New Poly Tower, 2 Zhongshan Liu
Rad, Guangzhou, China e-mail: zhangch@lgis.com.cn
Tel: 86-20-8326-6754 Fax: 86-20-8326-6287

■ **LS Industrial Systems Chengdu Office >> China**

Address: Room 2907, Zhong Yin B/D, No. 35, Renminzhong(2)-
Road, Chengdu, China e-mail: hongkonk@vip.163.com
Tel: 86-28-8612-9151 Fax: 86-28-8612-9236

■ **LS Industrial Systems Qingdao Office >> China**

Address: 12th Floor, Guodong building, No52 Jindun Road,
Chengdu, China e-mail: bellkuk@hanmail.net
Tel: 86-532-580-2539 Fax: 86-532-583-3793

※ LS Industrial Systems constantly endeavors to improve its product so that
Information in this manual is subject to change without notice.

SV-IS7 PLC Option /2009.04